

Chapter		Page
<b>1</b>	<b>Introduction</b>	<b>1</b>
1.1	General Description	1
1.2	Front Panel Description	2
1.3	Rear Panel Description	3
<b>2</b>	<b>Sensor Selection and Installation</b>	<b>4</b>
2.1	Sensor Selection	4
2.2	In-Line Sensor Installations	6
2.3	Submersible Sensor Installations	8
<b>3</b>	<b>Installation and Wiring</b>	<b>9</b>
3.1	Mounting Instructions	9
3.2	Power Connections	10
3.3	Input Connections	11
3.4	Output Relay Connections	12
3.5	Verifying Analog Outputs	13
3.6	Analog Output Connections	14
<b>4</b>	<b>System Configuration</b>	<b>15</b>
4.1	Introduction	15
4.2	CAL Menu Functions	16
4.3	RELAY Menu Functions	18
4.4	OUTPUT Menu Functions	19
4.5	<b><i>Quick-Reference Keypad Sequence</i></b>	20
4.6	CAL Menu	22
4.7	Wet Calibration Procedure	24
4.8	Relay Operation	25
4.9	RELAY Menu	27
4.10	OUTPUT Menu	29
4.11	View Only Menus	30
<b>5</b>	<b>Technical Support</b>	<b>32</b>
5.1	Accessing Internal Options	32
5.2	AC Power Configurations	33
5.3	Security Code Function	33
5.4	Installing Input/Output Options	34
5.5	Output Card Configurations	34
5.6	Options and Accessories	35

## Table of Contents

5.7	Parts Per Million Conversion Factor	36
5.8	Temperature Coefficient	37
5.9	Troubleshooting	39
	<b>Specifications</b>	<b>42</b>
	<b>Warranty Information</b>	<b>45</b>

# Important Safety Information!

**CAUTION:** Remove AC power to unit prior to wiring input and output connections.



**CAUTION:** Remove AC power before opening unit. Electrical shock hazard exists

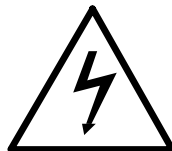

## Unpacking and Inspection

Your controller package includes the following items:

- OMEGA CDCN-90A Conductivity/Resistivity Controller
- Two stainless steel mounting brackets
- Mounting Instructions w/self-adhesive template
- Panel gasket
- Instruction manual w/warranty card

Please fill out and return warranty card as soon as possible.

## Warranty Record

For your protection, record your unit's purchase date and serial number for future reference. The serial number decal is located on the instrument's rear panel.

**Model: OMEGA CDCN-90A Conductivity/  
Resistivity Controller**

**Purchase Date:** \_\_\_\_\_

**Serial Number:** \_\_\_\_\_

**Purchased From:** \_\_\_\_\_

**Purchase Order Number:** \_\_\_\_\_

# Chapter 1

## Introduction

### 1.1 General Description

The OMEGA CDCN-90A Conductivity/Resistivity Controller is specifically designed to monitor and control conductivity levels of aqueous solutions. The controller's compact 1/4 DIN enclosure (front) is NEMA 4X/IP65 rated and ideal for installations into instrumentation panels with limited space.

Optional "plug-in" output cards allow you to customize your controller to satisfy your application demands. The controller's unique "slide-out" chassis design makes option installation fast and simple. Smart self-configuring microprocessor based circuitry automatically inventories installed options during power-up, allowing you to upgrade your system in seconds without the need for additional equipment.







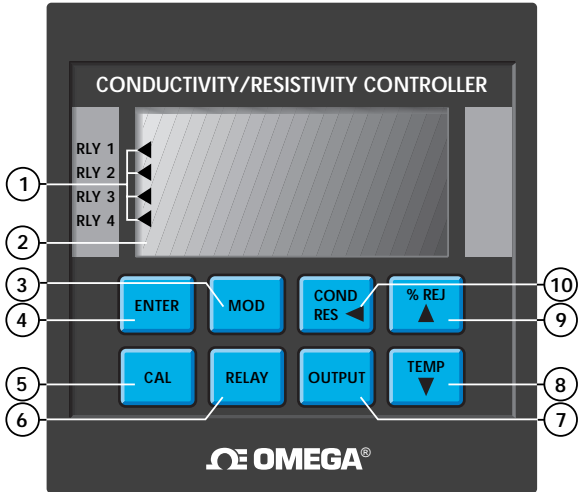

The unit's front panel features a highly visible 4.5 and 8-digit liquid crystal display with adjustable contrast. Measured conductivity/resistivity and relay status is accessed at a glance. Channel selection and solution temperature is accessed with a touch of a button. During calibration the user is prompted with clear step-by-step instructions on the front panel display.

The CDCN-90A is designed for use with OMEGA CDCE-90 series conductivity/resistivity sensors, covering a wide range of conductivity/resistivity measurement. Each sensor is equipped with a PT1000 temperature compensation device for accurate temperature sensing (sec. 2.1).

*The technical data given in this publication is for general information purposes only. It implies no warranty of any kind.*

## 1.2 Front Panel Description



Item	Function
1. Relay Annunciators:	<ul style="list-style-type: none"> <li>Indicate activation status of control relays 1-4 (optional)</li> </ul>
2. LCD Display:	<ul style="list-style-type: none"> <li>Shows conductivity, resistivity, temperature °C, relay activation status, and user messages during setup and operation</li> </ul>
3. 	<ul style="list-style-type: none"> <li>Accesses one of three calibration menus: CAL, RELAY, OUTPUT</li> <li>Selects a menu item for modification</li> <li>Restores a menu item to previous value during modification</li> </ul>
4. 	<ul style="list-style-type: none"> <li>Stores calibration and setup values into memory after modification</li> <li>Displays available output options during operation</li> </ul>
5. 	<ul style="list-style-type: none"> <li>Used in conjunction with MOD key to access the CAL calibration menu</li> <li>Accesses the CAL "view-only" menu</li> </ul>
6. 	<ul style="list-style-type: none"> <li>Used in conjunction with MOD key to access the RELAY calibration menu</li> <li>Accesses the RELAY "view-only" menu</li> </ul>
7. 	<ul style="list-style-type: none"> <li>Used in conjunction with MOD key to access the OUTPUT calibration menu</li> <li>Accesses the OUTPUT "view-only" menu</li> </ul>
8. 	<ul style="list-style-type: none"> <li>Displays temperature in °C for each channel during operation</li> <li>Decreases the value of a selected digit in CAL, RELAY, or OUTPUT menus</li> </ul>
9. 	<ul style="list-style-type: none"> <li>Displays percent rejection between channels</li> <li>Increases the value of a selected digit in CAL, RELAY, or OUTPUT menus</li> </ul>
10. 	<ul style="list-style-type: none"> <li>Displays conductivity/resistivity for each channel during operation</li> <li>Selects a digit for modification while in CAL, RELAY, or OUTPUT menus</li> <li>Returns the unit to operation mode from menus</li> </ul>

# 1.3 Rear Panel Description

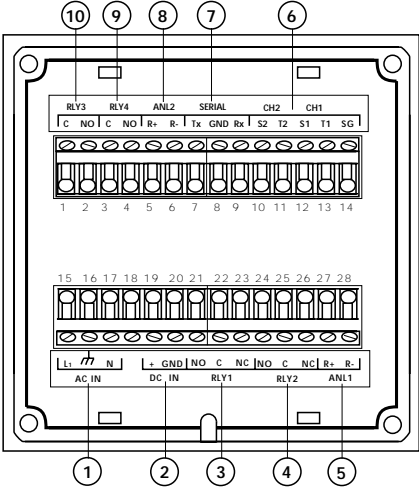

**Note:** Rear terminals accept 18 to 22 AWG wire

Function	Item
<ul style="list-style-type: none"> <li>90 to 132 VAC or 180 to 264 VAC system power connection</li> </ul>	1. AC IN
<ul style="list-style-type: none"> <li>17 to 30 VDC system power connection</li> </ul>	2. DC IN
<ul style="list-style-type: none"> <li>Relay #1 (COM, NO, NC) contact set for external device control (optional)</li> </ul>	3. RLY1
<ul style="list-style-type: none"> <li>Relay #2 (COM, NO, NC) contact set for external device control (optional)</li> </ul>	4. RLY2
<ul style="list-style-type: none"> <li>Analog output #1 from option socket #1 (optional)</li> </ul>	5. ANL1
<ul style="list-style-type: none"> <li>Sensor input connections</li> </ul>	6. CH1/CH2
<ul style="list-style-type: none"> <li>Serial outputs (future availability)</li> </ul>	7. SERIAL
<ul style="list-style-type: none"> <li>Analog output #2 from option socket #2 (optional)</li> </ul>	8. ANL2
<ul style="list-style-type: none"> <li>Relay #4 (COM, NO) contact set for external device control (optional)</li> </ul>	9. RLY4
<ul style="list-style-type: none"> <li>Relay #3 (COM, NO) contact set for external device control (optional)</li> </ul>	10. RLY3

# Chapter 2

## Sensor Selection and Installation

### 2.1 Sensor Selection

The CDCN-90A controller is compatible with CDCE-90 series sensors. OMEGA Engineering offers five sensor versions satisfying a wide range of measurement, listed below.

For optimum sensor performance and life, the following requirements MUST be met:

- Verify your system's conductivity/resistivity range.
- Verify the maximum pressure/temperature specification for the sensor under consideration is within your process range.
- Verify wetted sensor parts are chemically compatible with process fluids (e.g. Compass Corrosion Guide or equivalent).

Choose the OMEGA Engineering sensor best suited for your application from the following:

#### Dimensions:

- CDCE-90-001 Sensor
- CDCE-90-01 Sensor
- CDCE-90-1 Sensor

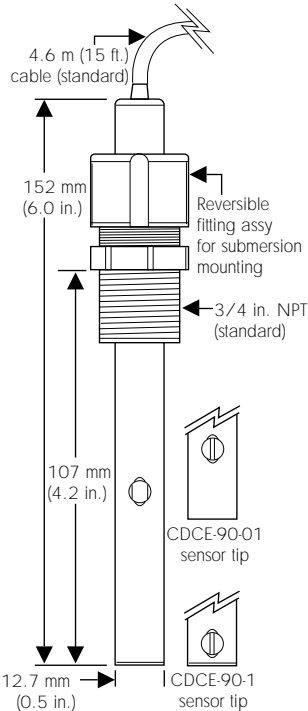

Order Number	Cell	Range	NPT Fitting	Fitting Material
CDCE-90-001	0.01	0.055 - 100 $\mu\text{S}$ (10 $\text{k}\Omega$ -18 $\text{M}\Omega$ ★)	3/4 in.	PP
CDCE-90-01	0.1	1 - 1000 $\mu\text{S}$	3/4 in.	PP
CDCE-90-1	1.0	10 - 10,000 $\mu\text{S}$	3/4 in.	PP

#### Specifications

Temperature Compensation: PT1000

Wetted materials:

O-rings:	EPR
Insulator:	Teflon®
Electrodes:	316 stainless steel
Standard fitting:	Polypropylene
Max. pressure:	100 psi/6.9 bar
Max. temperature:	212 °F/100 °C
Optional fitting:	316 SS (1/2 in. NPT) #3-2820.392
Max. pressure:	200 psi/13.8 bar
Max. temperature:	248 °F/120 °C

★ Resistivity measurements within the 10 MΩ to 18 MΩ (0.055 μS to 0.1 μS) range must be performed in solution temperatures from 20 °C to 100 °C.

Order Number	Cell Range	NPT Fitting	Fitting Material
CDCE-90-10	10.0 100 - 100,000 μS	3/4 in.	316 SS

**Specifications**

Temperature Compensation: PT1000

Wetted materials:  
 O-rings: EPR  
 Insulator: CPVC  
 Electrodes: 316 stainless steel  
 Standard fitting: 316 SS  
 Max. pressure: 100 psi /6.9 bar  
 Max. temperature: 203 °F /95 °C

Optional Submersion Adapter Fitting: 316 SS, #3-2820.390

Plastic pipe/tank installations: When two CDCE-90-10 sensors connected to the same controller, a minimum of 10 ft/3 m is required between sensors, if placed in the same solution.

Metal pipe/tank installations: A CDCE-90-10 will not work with a CDCE-90-20 sensor in the same system. Use two CDCE-90-20 sensors in these applications.

**Dimensions:**

CDCE-90-10 Sensor

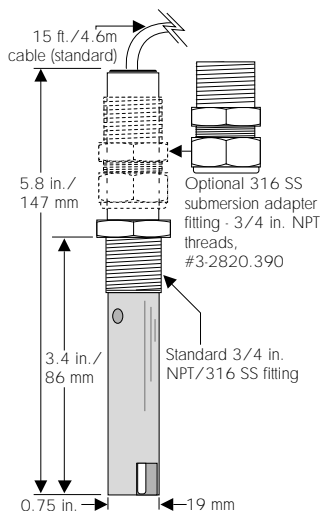

## Dimensions

CDCE-90-20 Sensor

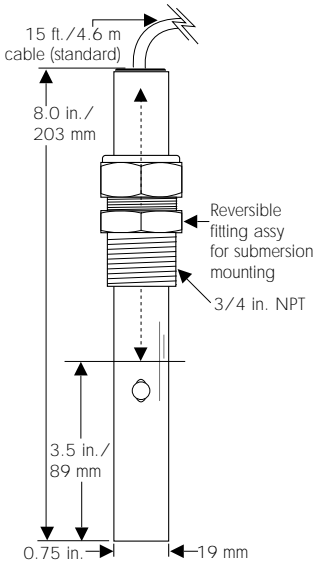

Order Number	Cell	Range	NPT Fitting	Fitting Material
CDCE-90-20	20.0	200 - 400,000 $\mu\text{S}$	3/4 in.	316 SS

### Specifications

Temperature Compensation: PT1000

Wetted materials:

O-rings:	EPR
Insulator:	Teflon
Electrodes:	316 stainless steel
Fitting:	316 stainless steel
Max. pressure:	100 psi / 6.9 bar
Max. temperature:	302 °F / 150 °C

## 2.2 In-line Sensor Installations

OMEGA CDCE-90 series sensors are easily mounted using standard female pipe fittings available at local hardware stores.

For optimum system performance, several mounting techniques must be observed. In-line applications require special considerations unlike most submersible types. Factors such as air bubbles, "dead zones", excessive flow rates, and sediment buildup are problems associated with pipeline installations.

Air bubbles around the sensor electrodes can cause the sensor to read lower conductivity values than actual. Pockets or "dead zones" may produce inaccurate reading since they isolate the sensor from the main process stream.

Oils or sediments in the system can coat or clog the sensor electrodes, causing poor response or no response at all.

Mount the sensor in a location where the flow rate is moderate. Ideally, the sensor should be mounted where flow is directed into the sensor cavity (e.g. elbow, tee).

Refer to the following illustration for recommended mounting techniques.

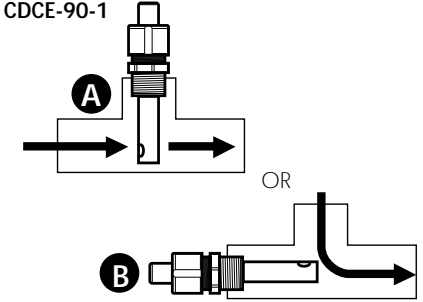
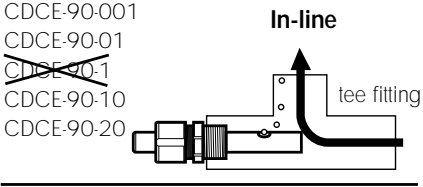

Use caution to avoid air bubble or sediment trapping inside the electrode cavity.

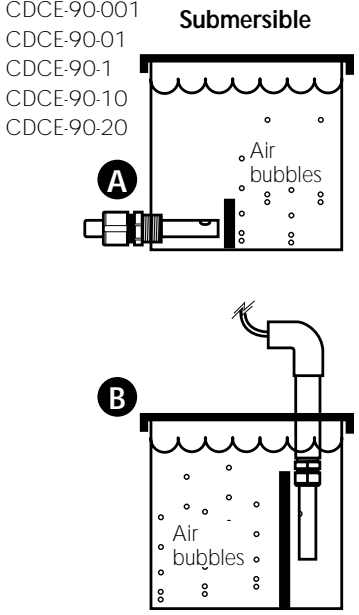

- Refer to your sensor instruction manual for specific sensor assembly and mounting instructions.
- For other installations, contact your local Omega Engineering distributor for additional information.
- After the sensor is first installed and the pipe is filled with fluid, gently tap the sensor fitting several times to release any air bubbles trapped within the sensor cavity.

## 2.3 Submersible Sensor Installations

OMEGA CDCE-90-001, CDCE-90-01, and CDCE-90-1 sensors are easily modified for submersible installation. An extension pipe and female pipe union are required (customer supplied).

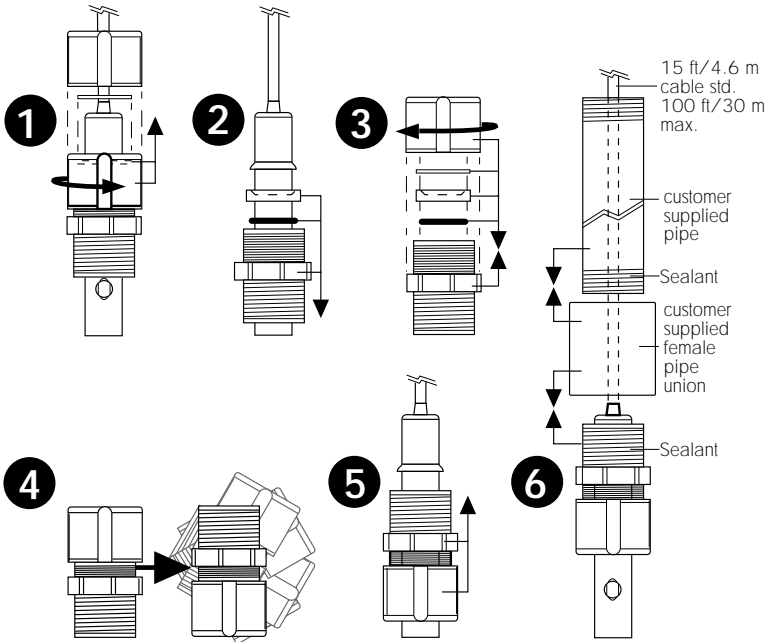

- **CDCE-90-10 sensor:** this sensor can be submersed via the optional submersion adapter fitting #3-2820.390.
- **CDCE-90-20 sensor:** conversion for submersion mounting is similar to the illustration above. Simply reverse the sensor's metal swedgelock fitting assembly and refer to step #6 above.
- Shake the sensor/pipe assembly after submersion to remove any trapped air bubbles inside the electrode cavity. Aerated tanks may require baffles to separate the sensor from bubble streams. Avoid mounting locations where bubbles are present.

### 3.1 Mounting Instructions

The controller's 1/4 DIN enclosure is specifically designed for panel mounting. Adjustable mounting brackets allow mounting in panels up to 1 in./25 mm thick. An adhesive template and instructions are included to insure proper installation.

For outdoor and/or stand alone installations the splash-proof NEMA 4X/IP65 rear cover kit is recommended (ordered separately, PHOR-9RC).

## Chapter 3

## Installation and Wiring

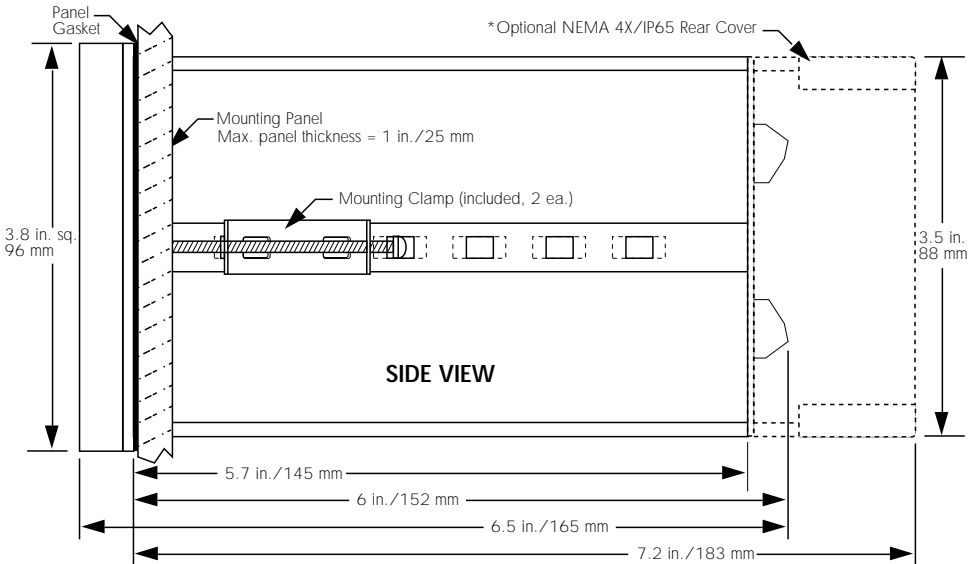

### Panel Cutout Instructions

Recommended panel cutout 3.54 in./90 mm square. Maximum panel cutout 3.62 in./92 mm square, DO NOT exceed. Use adhesive backed template (included).

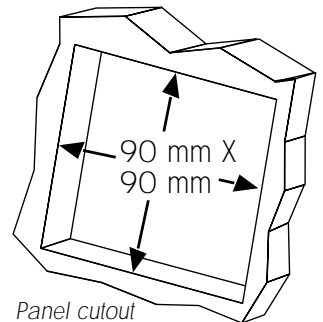

## 3.2 Power Connections

### AC Power Connections



Caution: Never connect live AC lines to the instrument.  
Electrical shock hazard exists

DC power is recommended when ground fault interrupt devices (GFI's) are used.

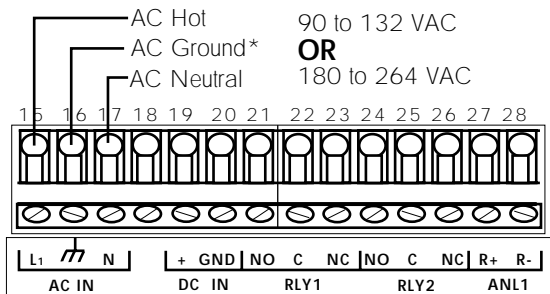

### Instructions

1. Jumper selectable for 90 to 132 **OR** 180 to 264 VAC operation. Confirm AC power configuration before applying power (sec. 5.2).
2. DC power can be connected simultaneously as a backup power source, see section below.
3. \*A direct or low impedance AC ground (earth ground) MUST be used for proper operation.
4. To reduce the possibility of noise interference, AC power lines must be isolated from signal lines.

### DC Power Connections



Caution: Never connect live DC lines to the instrument.  
Electrical shock hazard exists

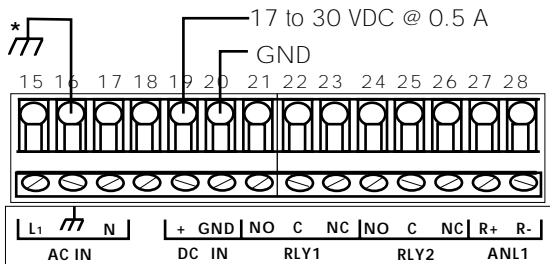

Note: AC/DC power can be connected simultaneously, using DC power as an backup power source.

\*A direct or low impedance earth ground must be used for optimum performance

### 3.3 Input Connections

The CDCN-90A is compatible with OMEGA CDCE-90 series sensors. Wiring connections are identical for ALL sensor versions.



*Caution: Remove instrument power prior to making any input/output connection. Failure to do so may result in personal injury or damage to the instrument.*

**Extended Cable Runs:** Each sensor includes 15 ft/4.6 m of cable. Cable runs can extend up to 100 ft/30 m using three conductor shielded cable.

- Shielding **must** be exactly as shown below
- Shielding **must** be maintained through cable splice with cable extensions.

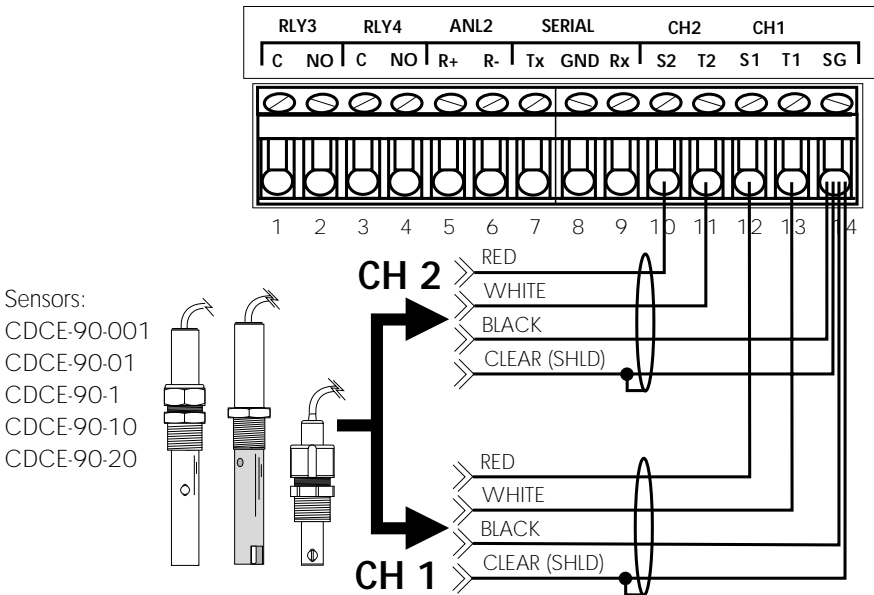

#### Special Considerations:

*To reduce the possibility of noise interference, separate sensor input lines from AC power lines.*

### 3.4 Output Relay Connections

Up to two optional relay cards can be installed for external device control. Each card contains two independent relays controlled by either channel. One of three relay modes are selected for each relay (sec. 4.8). Relay contacts are rated at 5 A maximum.

The CDCN-90A will accept **one of each** of the following cards:

- 2-Relay Card: Provides two single pole double throw relays (sec. 5.4).
- Dual Proportional Relay Card: Provides two single pole single throw relays (sec. 5.4).

**The 2-Relay Card** provides both normally open (NO) and normally closed (NC) contacts which may be used simultaneously. **Example:** Device A IS powered when relay 1 is off. Power is discontinued when relay 1's alarm setpoint is reached. Device B IS NOT powered when relay 1 is off. Power is applied when relay 1's alarm setpoint is reached, see illustration below:

#### Special Considerations:

Relay contacts are rated as 5 A @ 250 VAC OR 5 A @ 30 VDC max.

An external heavy-duty relay must be used for devices with surge currents or operating currents that exceed 5 A.

To reduce the possibility of noise interference, separate AC relay lines from input/output lines.

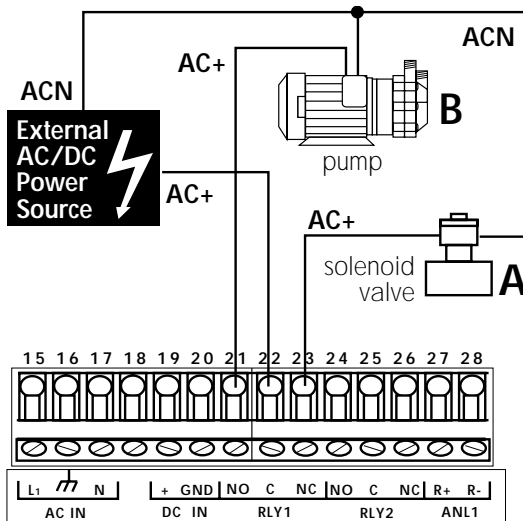

**The Dual Proportional Relay Card** provides a normally open (NO) contact for external device control. The main distinction from the 2-Relay card is the lack of the normally closed (NC) contact.

**Example:** Device A IS NOT powered when relay 3 is off. Power is applied when relay 3's alarm setpoint is reached. Relay 4 operation is identical to Relay 3, see illustration below:

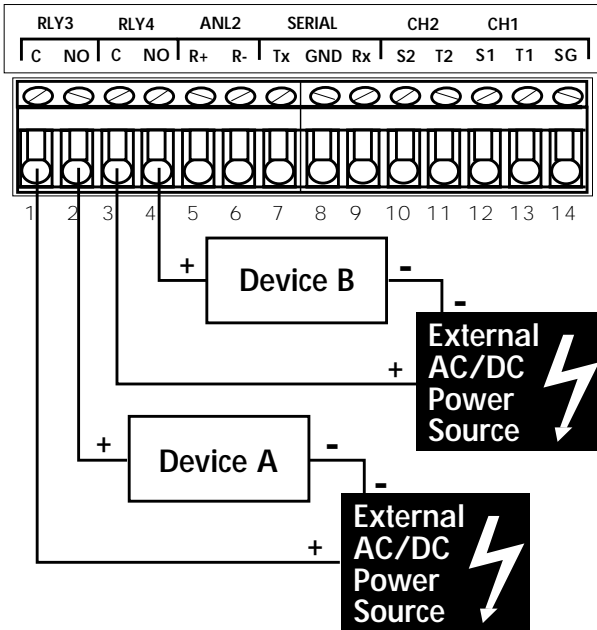

**Special Considerations:**

Relay contacts are rated as  
5 A @ 250 VAC OR  
5 A @ 30 VDC maximum.

*To reduce the possibility of noise interference, separate AC relay lines from input/output lines.*

**3.5 Verifying Analog Outputs**

Installed output options can be configured to either of the unit's rear analog output terminals: ANL 1 or ANL 2. Configuration is determined by which sockets the options are installed. Options installed in socket #1 are configured to the rear ANL 1 terminals, options installed in socket #2 are configured to the rear ANL 2 terminals (sec. 5.4).

Prior to connection, determine which options are configured to terminals ANL 1 and ANL 2 as follows:

**Option Record:**

ANL 1=

---

ANL 2=

---

1. Apply power to unit. Press:  to view available output options on the front panel display (unit displays "No Card" for unavailable options).
2. Record option configurations for ANL 1 and ANL 2 in the spaces provided (left). This information is necessary when wiring analog outputs.

### 3.6 Analog Output Connections

0 to 20/4 to 20 mA isolated or non-isolated outputs as well as 0 to 5/0 to 10 VDC isolated or non-isolated outputs are available (sec. 5.5).

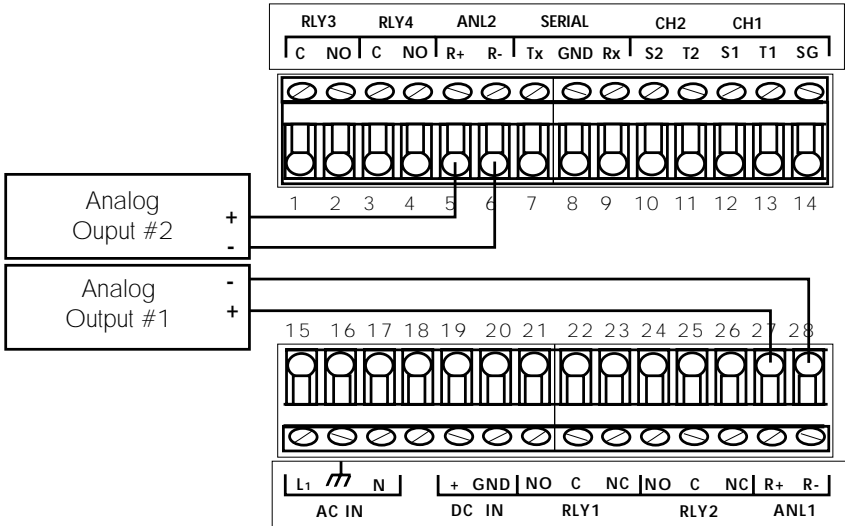

**Special Considerations:**

The maximum loop impedance for the 4 to 20 mA/0 to 20 mA output is 425 Ω. The minimum load impedance for the 0 to 5/0 to 10 V output is 1 kΩ (1000 Ω). To reduce the possibility of noise interference, separate output lines from AC power/relay lines.

## Chapter 4

# System Configuration

### 4.1 Introduction

All functions which can be modified are contained in three menus:

**The CAL menu** contains those functions related to the sensor input signal and how it is interpreted by the instrument. The CAL menu also provides access to the display contrast and security code features.

**The RELAY menu** contains those functions necessary to control any installed output relays.

**The Output menu** contains those functions which define and control all installed analog output cards.

#### CAL Menu Functions

- Channel 1 cell selection
- Channel 1 scale selection
- Channel 1 decimal selection
- Channel 1 parts per million factor  
(only shown with ppm scale selected)
- Channel 1 temp. coefficient (%/°C)
- Channel 1 wet cal. (see note below)
- Channel 2 on/off
  - (channel 2 off)
  - (channel 2 on)
    - Channel 2 cell selection
    - Channel 2 scale selection
    - Channel 2 decimal selection
    - Channel 2 parts per million factor  
(only shown with ppm scale selected)
    - Channel 2 temp. coefficient (%/°C)
    - Channel 2 wet cal. (see note below)
- Display contrast
- Security code

#### Wet Calibration, when selected

- Insert sensor in conductivity solution (buffer)
- Accept or modify displayed buffer temp.
- Accept or modify displayed conductivity/resistivity

(continued)

## RELAY Menu Functions

- Relay/channel control selection
- Relay mode: HI/LO, OR Pulse

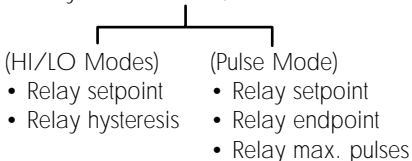

## OUTPUT Menu Functions

- Analog output 1 control selection
- Analog output 1 minimum setpoint
- Analog output 1 maximum setpoint
- Analog output 1 minimum adjust
- Analog output 1 maximum adjust
  
- Analog output 2 control selection
- Analog output 2 minimum setpoint
- Analog output 2 maximum setpoint
- Analog output 2 minimum adjust
- Analog output 2 maximum adjust

## 4.2 CAL Menu Functions

*Channel 1 sensor cell constant selection:*  
0.01, 0.1, 1.0, 10.0, 20.0

*Channel 1 scale selection:*  
 $\mu\text{S}$ , mS, PPM, Kohm, or Mohm

*Channel 1 decimal:*  
199.99 to 19999

*Channel 1 parts per million factor:* selectable from 1.00 to 3.00

**1. Channel 1 Cell Selection:** Allows user to select the channel 1 sensor cell constant.

**2. Channel 1 Scale Selection:** Allows user to select the channel 1 conductivity scale. Five scales are offered. The selected scale for this channel will display in the RELAY setup and OUTPUT setup menu.

**3. Channel 1 Decimal:** Allows the user to select the decimal position for the selected CH1 scale. Decimal selection will display in relay setup and output setup menus.

**4. Channel 1 Parts Per Million Factor:** Allows the user to adjust the relationship between solution conductivity ( $\mu\text{S}$ ) and the total dissolved solid (TDS) in parts per million units (PPM). The common value for most natural occurring salts is 2.00 (factory default). This function is not shown in the CAL menu unless a ppm scale is selected (step 2). The ppm relationship varies between chemicals (sec. 5.7).

**5. Channel 1 Temperature Compensation:** The temperature compensation value keeps the process solution conductivity reading constant during temperature changes. All conductivity readings are based on 25 °C. A 2% conductivity change for each °C is common for many chemicals (factory default). However, many chemicals react differently to temperature change (sec. 5.8).

*Channel 1 temperature compensation percentage: selectable from 0.00 to 9.99%/°C*

**6. Channel 1 Wet Calibration:** Wet calibration is a procedure that calibrates your system for maximum accuracy. Wet calibration should be performed during "first-time" system start-up and at regular intervals. A solution of known conductivity or resistivity (e.g. buffer) and an accurate thermometer are required for calibration. Calibration steps include:

- Unit display "CH1 INSERT". Place CH1 sensor in known solution or buffer.
- Unit displays solution temperature. After allowing for stabilization, the operator can accept or modify the displayed solution temperature.
- Unit displays solution value. Operator can either accept or modify displayed value.
- Steps repeat for channel 2 (when enabled)

**Note:** *Enter actual solution temperature and value for maximum system accuracy*

**7. Channel 2 On/Off:** When "on", CAL menu steps 1-6 repeat for channel 2 setup. When off, channel 2 functions are not shown in the CAL menu. When "off", all analog output signals assigned to channel 2 are forced low, and relays assigned to channel 2 are de-energized.

*Note: Turn channel 2 OFF to simplify single channel system setup.*

**8. Display Contrast:** Changes the LCD display contrast for best visibility.

(continued)

Security code selection:  
0000 to 9999

**9. Security Code Selection:** Changes the 4-digit security code. When enabled, the security code prevents unauthorized menu changes. The security function can be disabled by changing an internal dip switch setting (sec. 5.3).

## 4.3 RELAY Menu Functions

Relay 1 control selections:  
CH1 or CH2,  $\mu$ S, mS, PPM,  
Kohm, or Mohm  
CH1 or CH2, temperature,  
% rejection

**1. Relay 1 Control Selection:** Relay 1 is controlled by either conductivity, resistivity, temperature, or % rejection.

- Conductivity/resistivity control: Relays assigned for conductivity or resistivity control are energized at specific levels programmed by the operator.
- Temperature control: Relays assigned for temperature control are energized at specific temperature levels programmed by the operator.
- % Rejection: Relays assigned for % rejection control are energized when a user programmed conductivity change (percentage) is measured between CH1 and CH2. **CH1 = high conductivity (feed), and CH2 = low conductivity (product).** This function is disabled when channel 2 is off.

% Rejection formula:

$$\% \text{ rejection} = 100\% (1 - CH2/CH1)$$

**2. Relay 1 Mode:** Relay 1 can be configured for either LO, HI, or proportional "Pulse" operation (sec. 4.8).

**3. Relay 1 Setpoint:** Changes the value at which relay 1 is energized.

Relay 1 setpoint: unlimited  
within selected range

**4. Relay 1 Hysteresis:** Changes the relay 1 hysteresis value. Hysteresis values directly effect the LO and HI relay modes. Hysteresis is used to prevent relay "chatter", caused by the control value (e.g. conductivity) hovering around the relay's setpoint (sec. 4.8).

*Relay 1 hysteresis: unlimited within selected range*

**5. Relay 1 Endpoint:** Changes the control value for relay 1's maximum pulse rate.

*Relay 1 endpoint: unlimited within selected range*

**6. Relay 1 Pulse Rate:** Changes the pulse rate for relay 1 (sec. 4.8).

*Relay 1 pulse rate: 0 to 120 pulses per minute maximum.*

**Functions 1-6 above repeat for relays 2-4, when installed.**

## 4.4 OUTPUT Menu Functions

**1. Analog Output 1 Control Selection:** Analog output control selections are identical to relay control selections (sec. 4.3).

*Analog output control selections: CH1 or CH2,  $\mu$ S, mS, PPM, Kohm, Mohm CH1 or CH2, temperature or % rejection.*

**2. Analog Output 1 Minimum Setpoint:** Allows the operator to enter the conductivity, resistivity, temperature, or % rejection value that corresponds to the minimum analog output level (e.g. 4 mA).

*Analog output 1 minimum setpoint: Selectable for any value within selected range.*

**3. Analog Output 1 Maximum Setpoint:** Allows the operator to enter the conductivity, resistivity, temperature, or % rejection value that corresponds to the maximum analog output level (e.g. 20 mA).

*Analog output 1 maximum setpoint: Selectable for any value within selected range.*

**4. Analog Output 1 Minimum Output Adjust:** Allows the operator to adjust the minimum analog output level from the front keypad. An accurate digital voltage meter (DVM) is required for calibration.

*Analog output 1 minimum adjust: Adjustable for maximum accuracy.*

(continued)

Analog output 1 maximum adjust: Adjustable for maximum accuracy.

### 5. Analog Output 1 Maximum Output Adjust:

Allows the operator to adjust the maximum analog output level from the front keypad. An accurate digital voltage meter (DVM) is required for calibration.

**Functions 1-5 above repeat for analog output 2, when installed.**

## 4.5 Quick-Reference Keypad Sequence





The following sequence is used to view, modify, and exit **all** setup menu functions. Familiarize yourself with this procedure before attempting CAL, RELAY, and OUTPUT menu setup (sec. 4.6, 4.9, and 4.10).



The security function can be disabled via. internal dip switch (sec. 5.2).

**Accessing any setup menu (step 3), forces all analog output signals low and temporarily de-energizes all available relays.**

1. Press:  to enable calibration sequence.

2. Enter security code (when active) using:   ; press:  to confirm.  
(the security code is factory preset to 0000)

3. Select menu:   or ; press menu key repeatedly to scroll through displayed menu.



4. Press:  to select displayed menu function for modification.

5. Modify item using:   ; press:  to recall previous value **OR**  to save.

6. Press:   or  to view next item.

7. Repeat steps 4-6 of this procedure to modify each menu item.

Exit menu by pressing: 

To exit or advance menu you must first press:  
 to save changes **OR** press:  to  
restore previous value, followed by:  to exit  
menu and return to operation mode.

**Cannot exit menu  
while editing?**

## 4.6 CAL Menu

The security function is not displayed when disabled (sec. 5.3).

Displays shown are for example only, actual displays may vary.

Menu access forces all analog output signals low and temporarily de-energizes available output relays.

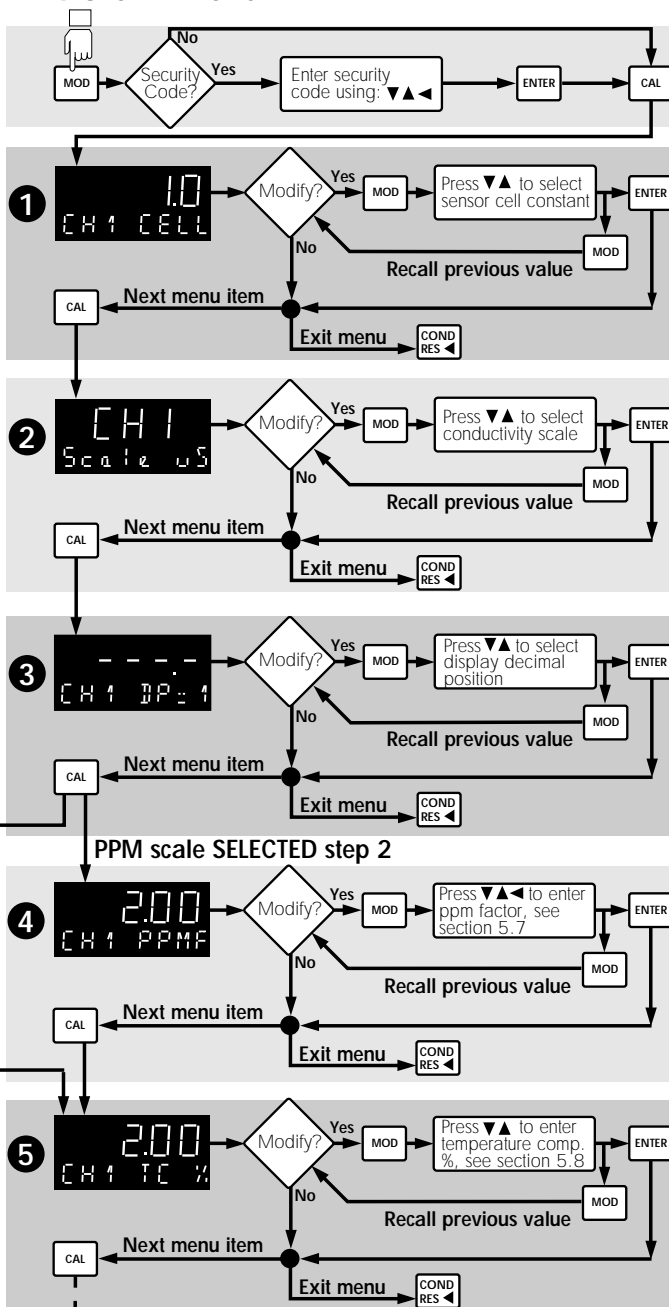

PPM scale  
NOT selected  
step 2

★An internal pure water curve is used for the 10 M $\Omega$  to 18 M $\Omega$  (0.055  $\mu S$  to 0.1  $\mu S$ ) range. The factory default setting of 2.00%/°C should be used for this range.

Continued on next page

Continued from previous page

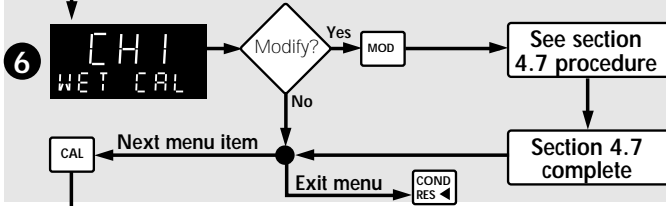

A known solution (sec. 5.6) is required for the "WET CAL" procedure (sec. 4.7).

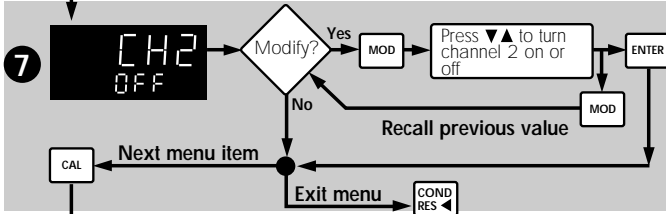

With CH2 ON, menu steps 1-6 repeat for CH2 setup. Step 7 is not shown after CH2 setup.

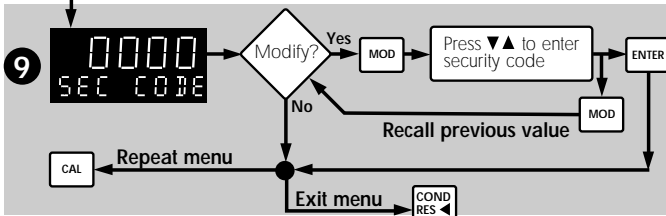
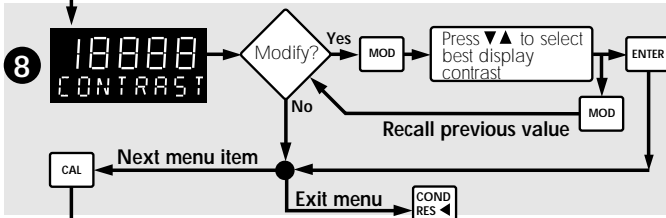

## Exit Wet Cal?

Press  at any time during steps 1-4 to exit wet cal procedure.

## 4.7 Wet Calibration Procedure

Wet calibration is necessary for maximum system accuracy. This procedure is recommended for "first-time" system start-up and for periodic sensor verification. A solution of known value (e.g. buffer), a clean container, and an accurate °C thermometer are required for calibration.

1. Access and scroll through the CAL Menu until the display shows "WET CAL" (sec. 4.6).



- Press  display shows "INSERT".

2. Place channel 1's sensor and °C thermometer into the known solution. Lightly tap the sensor electrode body against the side of the container to remove trapped air bubbles. Allow for temperature stabilization.

3. Solution temperature is now displayed. Accept or modify displayed value as follows:

Press  to accept displayed temperature, **OR**

Press  to enter actual solution temperature as follows:

A) Press    to enter measured temperature (°C).

B) Press  then  to cancel entry, **OR**

C) Press  to save entry and advance to step 4.

4. Solution value is now displayed. Accept or modify displayed value as follows:



Default display for CH1

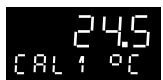

Temperature display example



Example enabled for change





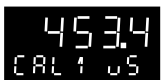

Example changed as measured



Conductivity display example



Press  to accept displayed value, **OR**

Press  to enter known value as follows:

A) Press    to change displayed value.

B) Press  then  to cancel entry, **OR**

C) Press  to save entry, "WET CAL" is now displayed. Three options are offered at this time:

- Press  to repeat the WET CAL procedure, **OR**
- Press  to advance to the next menu item, **OR**
- Press  to exit the CAL Menu and return to operation mode.



*Example enabled for change*



*Example changed to buffer value*

**Reset channel:** enter zero to reset factory defaults, if desired.

**Error message:** "Out of Range" (sec. 5.9)

## 4.8 Relay Operation

Up to four optional relays can be installed for external device control (sec. 3.4). Each relay can be assigned to either channel 1 or 2.

Relays are controlled by either conductivity, resistivity, temperature, or % rejection between channels, see section 4.3. Each relay can be selected for LO, HI or proportional "pulse" operation as follows:

## LO Relay Operation

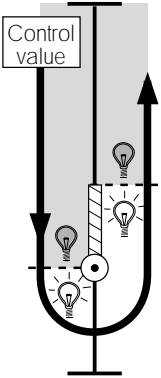

- = LO setpoint
- ▨ = Hysteresis
- 💡 = Relay energized
- 💡 = Relay de-energized

## HI Relay Operation

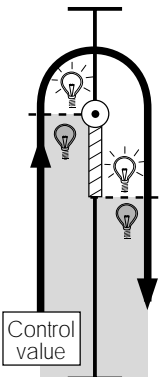

- = HI setpoint
- ▨ = Hysteresis
- 💡 = Relay energized
- 💡 = Relay de-energized

**LO/HI operation:** When a relay is selected for LO or HI operation, an individual setpoint and hysteresis value is entered for that relay.

- **Relay Setpoint:** Setpoints represent the control value at which the relay is energized. Setpoint units are displayed as  $\mu\text{S}$ , mS, ppm, k $\Omega$ , M $\Omega$ ,  $^{\circ}\text{C}$ , or % depending on the relay's assigned channel, range, and control selection (sec. 4.3).
- **Relay Hysteresis:** Hysteresis values directly effect the LO and HI relay modes. Hysteresis is used to prevent relay "chatter", caused by the control value (e.g. temperature) hovering around the relay's setpoint. If the measured control value is fluctuating, increase the hysteresis value to prevent relay chatter. If the measured control values is stable, decrease the hysteresis value to maximize relay sensitivity.

- **LO Relay Operation:** In LO operation, the relay is energized when the control value drops below the relay setpoint, and is de-energized when the control value rises above the setpoint plus hysteresis, see LO relay operation diagram (left).

- **HI Relay Operation:** In HI operation, the relay is energized when the control value rises above the relay setpoint, and is de-energized when the control value falls below the relay setpoint plus hysteresis, see HI relay operation diagram (left).

**Proportional "Pulse" Relay Operation:** The proportional pulse relay configuration is primarily designed for controlling metering pumps. Setpoints, endpoints, and maximum pulse rates are selected via the relay menu.

- Setpoint: Control value at which relay pulsing just begins.

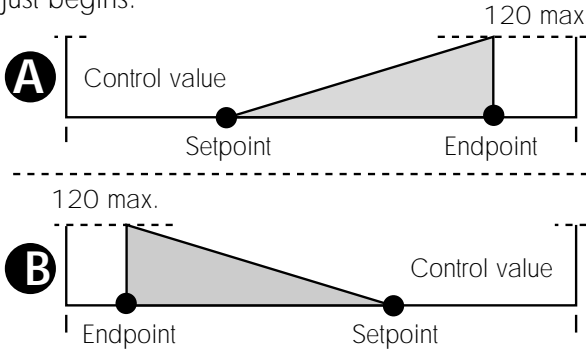

- Endpoint: Control value at which the relay pulse rate reaches the user set maximum value.
- Pulse Rate: User set from 0 to 120 pulses per minute maximum. Setting to 0 provides a quick way to disable an assigned relay.

## 4.9 RELAY Menu

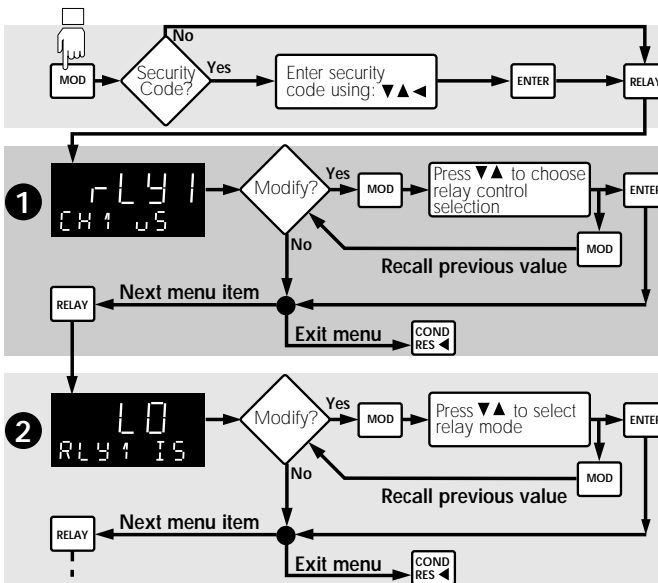

The security function is not displayed when disabled (sec. 5.3).

Displays shown are for example only, actual displays may vary.

**Menu access temporarily de-energizes available output relays and forces all analog outputs low.**

▼ Continued on next page

Continued from previous page

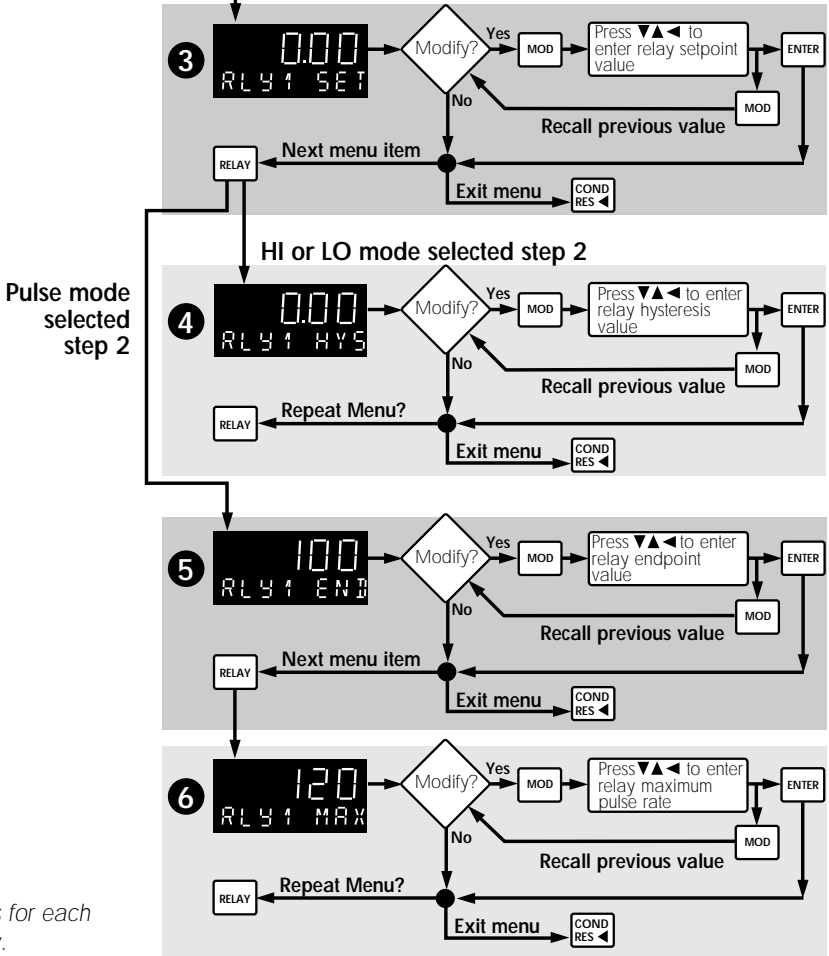

Menu repeats for each installed relay.

# 4.10 OUTPUT Menu

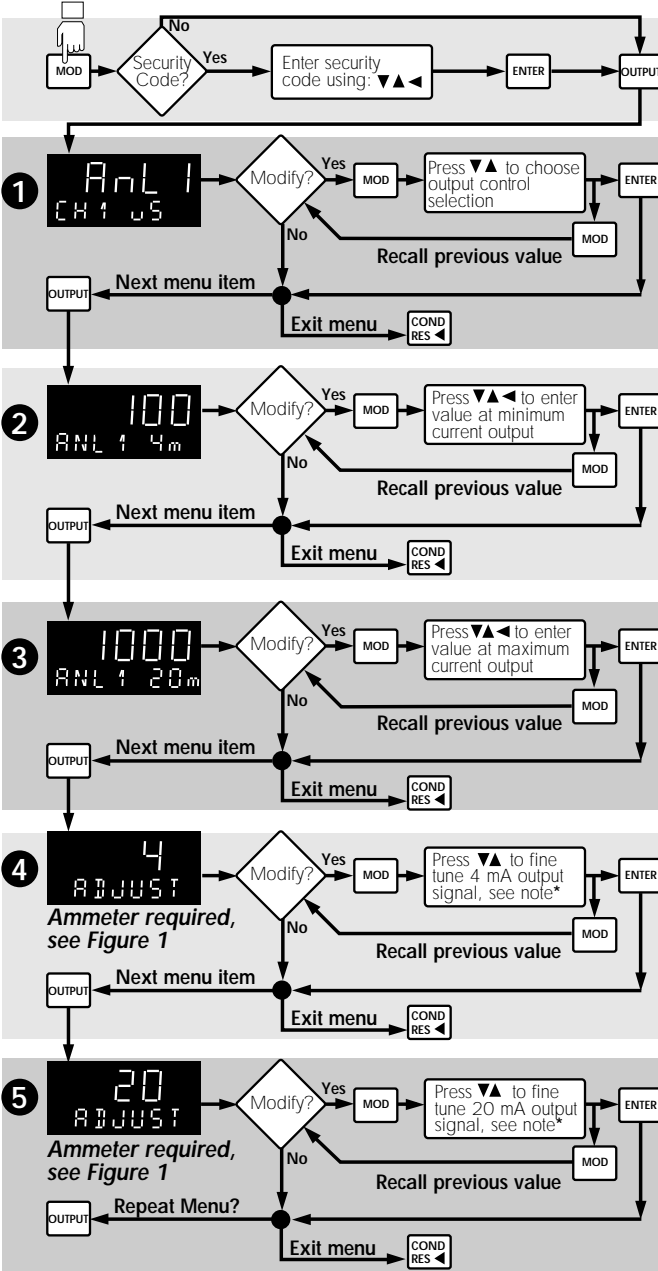

The security function is not displayed when disabled (sec. 5.2).

4 to 20/0 to 20 mA isolated/non-isolated options illustrated for example only, actual displays may vary.

Menu access forces all analog outputs low and temporarily de-energizes available output relays.

**Figure 1**  
\*The min. and max. current adjustment steps require an external ammeter for monitoring the current levels.

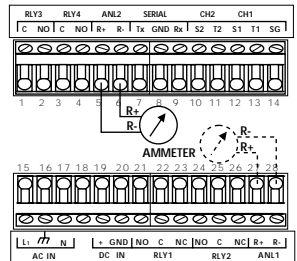

## 4.11 View Only Menus

Three "view-only" menus are available any time during operation. Menu access **does not** affect the measurement in any way.

Access the "view-only" menu of choice by pressing:



Each menu item is displayed in the following order by successively pressing the corresponding menu key:

### CAL View-Only Menu

*Displays shown are for example only, actual displays may vary.*

*Display steps 2 are shown only when channel 2 is on.*

1. Channel 1 cell constant selection:



2. Channel 2 cell constant selection:



### RELAY View-Only Menu

*Displays shown are for example only, actual displays may vary.*

*Function 4 only displays when HI or LO mode selections are made.*

*Function 5 only displays when the proportional "pulse" relay mode is selected.*

1. Relay 1 control selection:

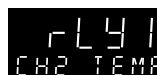

2. Relay 1 mode selection:

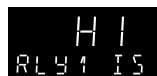

3. Relay 1 setpoint selection:



4. Relay 1 hysteresis selection:



5. Relay 1 endpoint selection:



4. Relay 1 maximum pulse rate selection:



*Function 6 only displays when the proportional "pulse" relay mode is selected.*

**Functions 1-6 repeat for all installed relays.**

### **OUTPUT View-Only Menu**

1. Analog output 1 control value selection:



*4 to 20 mA output option illustrated for example only, actual displays may vary.*

2. Analog output 1 minimum current output level selection:



3. Analog output 1 maximum current output level selection:



# Chapter 5

## Technical Support

### 5.1 Accessing Internal Options

1. Remove bezel (1) by placing a coin in the notch (2), twist coin to remove the bezel from the instrument casing, see Figure 2.

2. Loosen the four front bracket screws (3), then loosen the center "jackscrew" (4), see Figure 3.

3. Slide the electronics assembly (5) from the instrument casing, see Figure 4.

4. Lift upper retainer with adhesive gasket to install/remove plug-in cards. Be sure plug-in cards are properly seated in slots before reassembling instrument, see Figure 4.

Figure 2

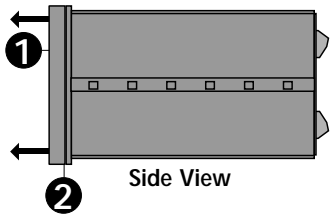

Figure 3

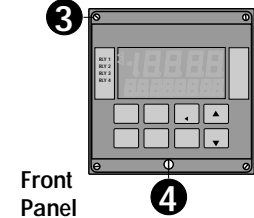
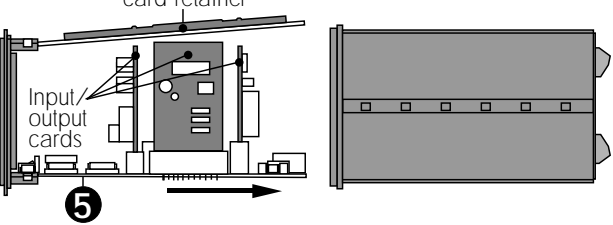
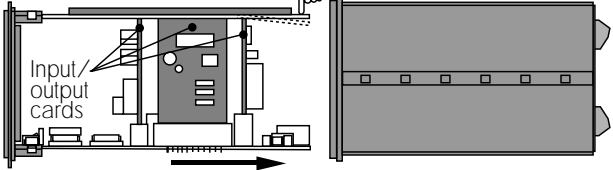

Figure 4



Push down on card retainer to slide the chassis back into the case.



## 5.2 AC Power Configurations

Two AC power options are possible; 90 to 132 VAC, or 180 to 264 VAC. Each power option is selectable via internal jumpers on the main pc board (fig. 5).

**Figure 5**

*Main pc board  
(top view)*

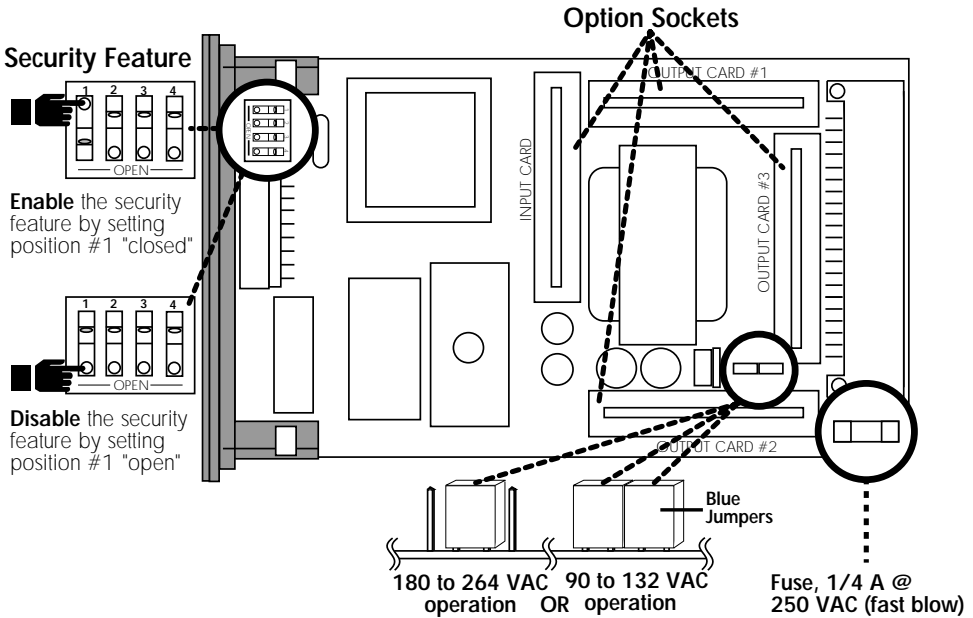

## 5.3 Security Code Function

The security function prompts the operator for a 4-digit code during setup menu access, when enabled. This function prohibits unauthorized entry and/or alterations to system parameters. The security code is factory preset to 0000. The code is programmable from 0000 to 9999 (sec. 4.6).



*Example shows the factory preset security code setting of 0000.*

The security function can be completely disabled by changing an internal dip switch setting (fig. 5). When disabled, the security function is no longer prompted during setup menu access.

## 5.4 Installing Input/Output Options

Input/output option cards are "keyed" for proper insertion into four sockets. These sockets are clearly marked on the unit's main pc board. See Figure 5 (pg 33) and table below:

Socket Labeled	Compatible Options
Input Card	Dedicated for input option cards
Output Card #1	Accepts all analog option cards, except the Dual Proportional Relay Card.
Output Card #2	Accepts all analog option cards and Dual Proportional Relay Card
Output Card #3	Dedicated for the 2-Relay Option Card

## 5.5 Output Card Configurations

Each 4 to 20/0 to 20 mA (iso or non-iso) output card contains jumper selections for the desired operation range:

- Place the blue jumper in position "A" for 4 to 20 mA operation.
- Place the blue jumper in position "B" for 0 to 20 mA operation.

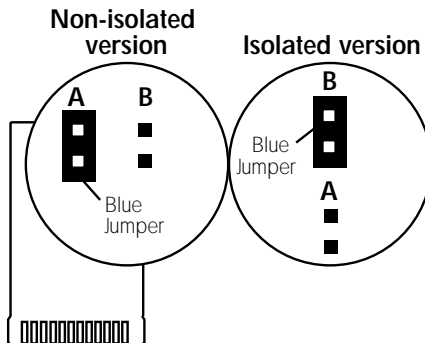

## 5.6 Options and Accessories

<b>Part Number</b>	<b>Output Cards</b>
PHOR-90-MA-N (Requires configuration, sec. 5.5)	4 to 20/0 to 20 mA (non-isolated)
PHOR-90-5V-N	0 to 5 VDC (non-isolated)
PHOR-90-10V-N	0 to 10 VDC (non-isolated)
PHOR-90-MA-I (Requires configuration, sec. 5.5)	4 to 20/0 to 20 mA (isolated)
PHOR-90-5V-I	0 to 5 VDC (isolated)
PHOR-90-10V-I	0 to 10 VDC (isolated)
PHOR-90-R2	2-Relay Card
PHOR-90-PC	Proportional Relay Card
<b>Part Number</b>	<b>Optional Accessories</b>
PHOR-9AP	Panel mounting adapter plate (5.5 in. to DIN cutout size)
PHCN-90-BRACKET	Surface mount bracket
PHOR-9RC	NEMA 4X/IP65 back cover kit (conduit connectors ordered below)
3-9000.392	Conduit connector kit for NEMA 4X/IP65 cover (3 pcs. included)
<b>Part Number</b>	<b>Spare Parts</b>
3-9000.525-1	Front Bezel
3-9000.575	Panel mounting gasket
3-9000.560	Mounting Clamp

Part Number	Spare Parts
2400-0404	Front cover screws (4 each)
3-9000.570	Front cover gasket

## 5.7 Parts Per Million Conversion Factor

The CDCN-90A is capable of displaying total dissolved solids (TDS) in parts per million (PPM) units. This is done by dividing the actual solution conductivity in  $\mu\text{S}$  by the programmed parts per million factor (PPMF).

$$\text{TDS (PPM)} = \frac{\text{Solution conductivity } (\mu\text{S})}{\text{PPMF}}$$

The factory default parts per million factor (PPMF) is 2.00 for example:

- PPMF = 2.00 (factory default)
- Solution conductivity is 400  $\mu\text{S}$
- TDS (PPM) =  $\frac{400}{2.00} = 200$  on the display

This PPM factor is adjustable from 1.00 to 3.00. This allows you to change the displayed PPM value based on your application. For example:

- PPMF = 1.25 (user programmed)
- Solution conductivity is 400  $\mu\text{S}$
- TDS (PPM) =  $\frac{400}{1.25} = 320$  on the display

## 5.8 Temperature Coefficient

Conductivity measurement is highly dependent on temperature. Temperature dependence is usually expressed as the relative change per °C, commonly known as percent/°C change from 25 °C, or slope of the solution.

Slopes can vary significantly depending on process solution type. The factory default temperature compensation factor is 2%/°C. This setting satisfies many general applications. Your process solution may require adjustment for maximum accuracy. The following procedure can be used to determine the optimum temperature compensation factor for your process. This procedure is handy when published reference handbooks are not available or your system consists of many chemical types.

### Equipment Required

- CDCN-90A controller with OMEGA Engineering Conductivity Sensor
- Process solution samples (2)

### Procedure

1. Disable the temperature compensation factor by entering 0.00 (sec. 4.6).

2. Heat the sample solution close to the maximum process temperature. Place sensor in the sample solution (allow several minutes for stabilization).

Record the displayed temperature and conductivity values in the spaces provided (left).

- Press:  to display temperature.
- Press:  to display conductivity.

(continued)

### Important:

★Do not use this procedure for solutions from 0.055  $\mu\text{S}$  to 0.1  $\mu\text{S}$  (10  $\text{M}\Omega$  to 18  $\text{M}\Omega$ ). An internal pure water curve is used for these ranges. The factory default setting of 2.00%/°C should be used.

### Sample Solution (Step 2)

Displayed temperature:

T1= \_\_\_\_\_°C

Displayed conductivity:

C1= \_\_\_\_\_

### Sample Solution (Step 3)

Displayed temperature:

T2 = \_\_\_\_\_ °C

Displayed conductivity:

C2 = \_\_\_\_\_

3. Cool the sample solution close to the minimum process temperature. Place sensor in the sample solution (allow several minutes for stabilization). Record displayed temperature and conductivity values in the spaces provided (right).

A 10% change in conductivity between steps 2 and 3 is required for optimum performance. If necessary, increase maximum (step 2) and reduce minimum (step 3) sample temperature. This will result in a larger change in conductivity between steps.

4. Substitute recorded readings (step 2 and 3) into the following formula:

$$\text{TC Slope} = \frac{100 \times (C1 - C2)}{(C2 \times (T1 - 25)) - (C1 \times (T2 - 25))}$$

A sample solution has a conductivity of 205  $\mu\text{S}$  @ 48 °C. After cooling the solution, the conductivity was measured at 150  $\mu\text{S}$  @ 23 °C. Therefore: C1 = 205, T1 = 48, C2 = 150, T2 = 23.

The TC is calculated as follows:

$$\begin{aligned} \text{TC Slope} &= \frac{100 \times (205 - 150)}{(150 \times (48 - 25)) - (205 \times (23 - 25))} \\ &= \frac{5500}{3860} = \mathbf{1.42\%/^{\circ}\text{C}} \end{aligned}$$

## 5.9 Troubleshooting

### CAL/RELAY/OUTPUT Menu Messages

Displayed Message	Cause	Solution
1. "...PPM FACTOR MUST BE BETWEEN 1 AND 3..."	Number entered outside range	Enter number between 1.00 and 3.00, factory default 2.00 (sec. 4.6)
2. "...MAX PULSE RATE MUST BE 120 OR LESS..."	Entered number too large	Enter number between 1 and 120, factory default 120 (sec. 4.9)
3. " _ _ _ _ "  (message shows in RELAY, OUTPUT, and VIEWMODE menus)	Relay or analog output setpoint too large for display decimal setting (display overrange)	A) Reenter new setpoint within displayed range (sec. 4.9, 4.10). Note: pressing MOD" when " _ _ _ _ " is displayed resets setpoint to 19999 B) Reset CAL menu display decimal, move to right for greater range (sec. 4.6).
4. "...SCALE OR DECIMAL CHANGED - CHECK RELAY AND OUTPUT SETTINGS..."	Changed previously selected scale or decimal setting	A) Press "LEFT "arrow key to cancel B) Change relay and output settings to reflect new scale selection, (sec. 4.9 - 4.10)
5. "CAL RESET"  (Wet Cal procedure only, sec. 4.7)	Zero entered for conductivity value during "Wet Cal" procedure	Note: unit resets to factory default values shown in sec. 4.6, 4.9, 4.10
6. "WAIT"	Minimum and/or maximum current output adjustment changed	Not Applicable
7. "CODE ERROR"	Wrong security code entered	Enter correct security code or disable feature (sec. 5.3)
8. "...Must be Less Than 18.1 Mohms..."	Wet Cal value out of range	Input value less than 18.1 Mohms for Wet Cal. (sec. 4.7)
9. "...Must be Greater than 0.549 uS..."	Wet Cal value out of range	Input value greater than 0.049 $\mu$ S for Wet Cal. (sec. 4.7)

## Operational Messages

Displayed Message	Cause	Solution
1. " _ _ _ _ " (4-dashes)	A) Displayed reading too large B) Temp. comp. % selection too large. C) Temp. input too high. D) Shorted or open sensor wiring	A) Change to larger scale or shift display decimal to the right (sec. 4.6) B) Verify temperature compensation % setting for your process (sec. 5.8) C) Verify sensor wiring or replace sensor (sec. 3.3). D) Verify sensor wiring (sec. 3.3).
2. " _ _ _ _ _ " (5-dashes)	Open or missing temperature signal from sensor	Verify sensor wiring or replace sensor (sec. 3.3)
3. "0.00", "0.0", OR "0" shown at all times (will not change)	A) Improperly wired or missing sensor B) Scale selection set too high C) Insufficient decimal resolution selected D) Temp. comp. % set too high with very low solution temp. E) Sensor cell not in solution F) Solution conductance too high or resistance too low for sensor used G) Shorted or open sensor wiring	A) Verify sensor connection (sec. 3.3) B) Set scale to lower value (e.g. ms to $\mu$ S, sec. 4.6) C) Display decimal resolution too low, move decimal to left (sec. 4.6) D) Verify temp. comp. % setting for your solution (sec. 5.8) E) Check sensor installation (sec. 2.2) F) Verify sensor range (sec. 2.1) G) Verify sensor wiring (sec. 3.3)
4. "...CHECK INPUT CARD..."	Wrong, missing, or damaged input card	A) Verify input card type (sec. 5.6) B) Install input card (sec. 5.4) C) Replace input card (sec. 5.1)
5. "...NO CARD..."	Missing or damaged card	A) Install card (sec. 5.4) B) Replace card (sec. 5.1)

(continued)

## Operational Messages Continued

Displayed Message	Cause	Solution
6. "...OUT OF RANGE"  (Wet Cal Only, sec. 4.7)	A) Temp. improperly entered or bad sensor B) Wrong sensor cell or wrong buffer for selected scale	A) Check solution temp. and sensor wiring (sec. 3.3) B) Verify cell range (sec. 2.1), check buffer value, verify scale selection (sec. 4.6)
7. "ERR CH2 OFF"	"% REJ" key pressed when CH2 is off	Turn CH2 on, if desired (sec. 4.6)
8. "VIEWMODE"	"ENTER" or "MOD" key pressed while in the "VIEW ONLY" menu	Press "LEFT" arrow key to return to operation mode, then press "MOD" key followed by the "CAL", "RELAY, or "OUTPUT" key for setup access

# Specifications

## General Data

Conductivity range: 0.055  $\mu\text{S}$  to 400,000  $\mu\text{S}$   
(2.5 $\Omega$  to 18 M $\Omega$ ★)

★Resistivity/conductivity measurements from 10 M $\Omega$  to 18 M $\Omega$  (0.055  $\mu\text{S}$  to 0.1  $\mu\text{S}$ ) must be performed in solution temperatures from 20 °C to 100 °C.

Temperature range: 0 to 100 °C  
Isolation: 500 VDC to earth ground  
Sensor compatibility: OMEGA CECE-90 Series  
Conductivity/Resistivity  
Sensors  
Liquid crystal display: 4.5-digit 0.5 inch high  
(upper), 8-digit 0.3 inch  
high (lower), 4 relay status  
annunciators  
Display accuracy:  $\pm 2\%$  of reading  
Display repeatability:  $\pm 0.5\%$  of reading  
Output accuracy:  $\pm 0.5\%$  of full scale  
Memory backup: Long life NovRam  
Temp. compensation: PT1000 compatible only

## Enclosure

Material: ABS plastic  
Rating: NEMA 4X/IP65 front  
NEMA 4X/IP65 rear  
cover kit (optional)

## Electrical Data

Power requirements: 17 to 30 VDC @  
0.5 A max. and/or  
90 to 132 VAC @  
50 to 60 Hz, or  
180 to 264 VAC @  
50 to 60 Hz (jumper  
selectable)  
Noise immunity: Meets IEC 801-2 level 4,  
IEC 801-3, level 1

(continued)

## Ambient Conditions

Operating temp.: 32 to 130 °F/0 to 55 °C  
Relative humidity: 95% maximum,  
non-condensing

## Optional Cards (Section 5.6)

### 2-Relay Card

Contacts: 2 SPDT outputs  
Rating: 5 A @ 250 VAC or 30 VDC  
maximum

### Dual Proportional Relay Card

Contacts: 2 SPST outputs  
Rating: 5 A @ 250 VAC or 30 VDC  
maximum

### 4 to 20/0 to 20 mA Output Card

Response time: 2.5s max. for 100% change  
Loop resistance: 425  $\Omega$  maximum  
Isolation: 500 VDC to earth ground

### 0 to 5/0 to 10 VDC Output Card

Response time: 2.5s max. for 100% change  
Load resistance: 1 k $\Omega$  minimum  
Isolation: 500 VDC to earth ground

**NOTES:**