

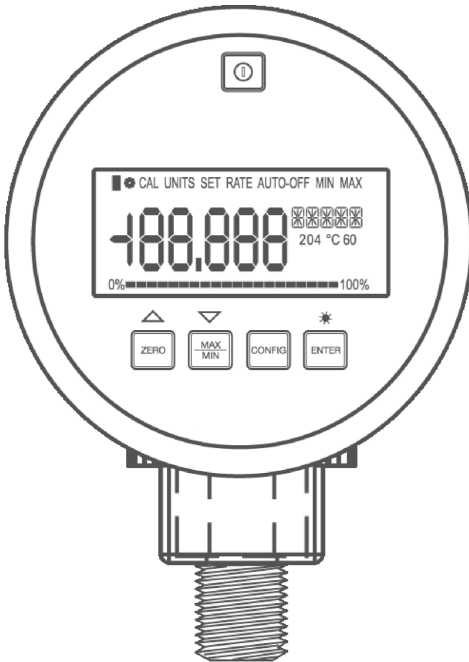

User's Guide



Shop online at

omega.com[®]

Ω OMEGA[®]

omega.com

e-mail: info@omega.com

For latest product manuals:

omegamanual.info



M-4290/0107 DPG4000 Digital Test Gauge



OMEGAnet® Online Service www.omega.com	Internet e-mail info@omega.com
---	---

Servicing North America:

USA:
ISO 9001 Certified

One Omega Drive, Box 4047
Stamford CT 06907-0047
Tel: (203) 359-1660 FAX: (203) 359-7700
e-mail: info@omega.com

Canada:

976 Bergar
Laval (Quebec) H7L 5A1, Canada
Tel: (514) 856-6928 FAX: (514) 856-6886
e-mail: info@omega.ca

For immediate technical or application assistance:

USA and Canada: Sales Service: 1-800-826-6342 / 1-800-TC-OMEGA®
Customer Service: 1-800-622-2378 / 1-800-622-BEST®
Engineering Service: 1-800-872-9436 / 1-800-USA-WHEN®
TELEX: 996404 EASYLINK: 62968934 CABLE: OMEGA

Mexico:

En Español: (001) 203-359-7803 e-mail: espanol@omega.com
FAX: (001) 203-359-7807 info@omega.com.mx

Servicing Europe:

Benelux:

Postbus 8034, 1180 LA Amstelveen, The Netherlands
Tel: +31 (0)20 3472121 FAX: +31 (0)20 6434643
Toll Free in Benelux: 0800 0993344
e-mail: sales@omegaeng.nl

Czech Republic:

Frystatska 184, 733 01 Karviná, Czech Republic
Tel: +420 (0)59 6311899 FAX: +420 (0)59 6311114
Toll Free: 0800-1-66342 e-mail: info@omegashop.cz

France:

11, rue Jacques Cartier, 78280 Guyancourt, France
Tel: +33 (0)1 61 37 2900 FAX: +33 (0)1 30 57 5427
Toll Free in France: 0800 466 342
e-mail: sales@omega.fr

Germany/Austria:

Daimlerstrasse 26, D-75392 Deckenpfronn, Germany
Tel: +49 (0)7056 9398-0 FAX: +49 (0)7056 9398-29
Toll Free in Germany: 0800 639 7678
e-mail: info@omega.de

United Kingdom:

ISO 9002 Certified

One Omega Drive, River Bend Technology Centre
Northbank, Irlam, Manchester
M44 5BD United Kingdom
Tel: +44 (0)161 777 6611 FAX: +44 (0)161 777 6622
Toll Free in United Kingdom: 0800-488-488
e-mail: sales@omega.co.uk

It is the policy of OMEGA to comply with all worldwide safety and EMC/EMI regulations that apply. OMEGA is constantly pursuing certification of its products to the European New Approach Directives. OMEGA will add the CE mark to every appropriate device upon certification.

The information contained in this document is believed to be correct, but OMEGA Engineering, Inc. accepts no liability for any errors it contains, and reserves the right to alter specifications without notice.

WARNING: These products are not designed for use in, and should not be used for, human applications.

Introduction

The DPG4000 combines the high accuracy of digital electronics with the convenience and ease of use of an analog test gauge. Accurate to $\pm 0.05\%$ FS, the DPG4000 can be used as a calibration reference, or in any application where high accuracy pressure measurement is required.

Many user configurable functions have been designed into the DPG4000 including sampling rate, TARE, damping, auto shut off, and min-max. Once the gauge is configured, settings can be locked and password protected to prevent unauthorized changes to configuration.

1.1 Customer Service

Omega Engineering

One Omega Drive
Box 4047
Stamford, CT 06907-0047

Tel: (203) 359-1660

Fax: (203) 359-7811

www.omega.com

email: cservice@omega.com

1.2 Standard Equipment









Check to see that your DPG4000 has arrived intact. Batteries are factory installed unless you have purchased the optional 24V powered version, in which case batteries are not supplied or installed. Save the packing materials at least until you have verified that there is no concealed damage.

1.3 Safety information

A Warning identifies conditions and actions that pose hazard(s) to the user; a Caution identifies conditions and actions that may damage the Calibrator or the equipment under test.

Symbols Used

The following table lists the International Electrical Symbols. Some or all of these symbols may be used on the instrument or in this manual.

Symbol	Description
	Power OFF
	Power ON
	Earth ground
	Risk of Danger. Important information. Refer to manual.
	Battery
	Hazardous Voltage
	Conforms to ATEX requirements
	Conforms to relevant European Union directives.
	Wheeled bin, conforms to EC directive 2002/96/EC

Hazard Location Information

Ex Hazardous Areas

An Ex-hazardous area as used in this manual refers to an area made hazardous by the potential presence of flammable or explosive vapors. These areas are also referred to as hazardous locations, see NFPA 70 Article 500.

Misuse

Should the DPG4000 be exposed to overpressure or sudden physical shock (i.e. being dropped) it should be examined for any damage that may cause a safety concern. If in doubt please return the unit for evaluation to Omega Engineering, Inc. Please refer to the Customer Service Section for contact information.



Caution

To avoid possible damage to calibrator or to equipment under test:

- If the message changes to "OL" the range limit is exceeded and the pressure source must immediately be removed from the DPG4000 to prevent damage to the pressure transducer inside.
- Maximum torque allowed is 13,5 Nm = 10 ftlbs. NEVER exceed the torque allowed.

DPG4000 Display and Controls

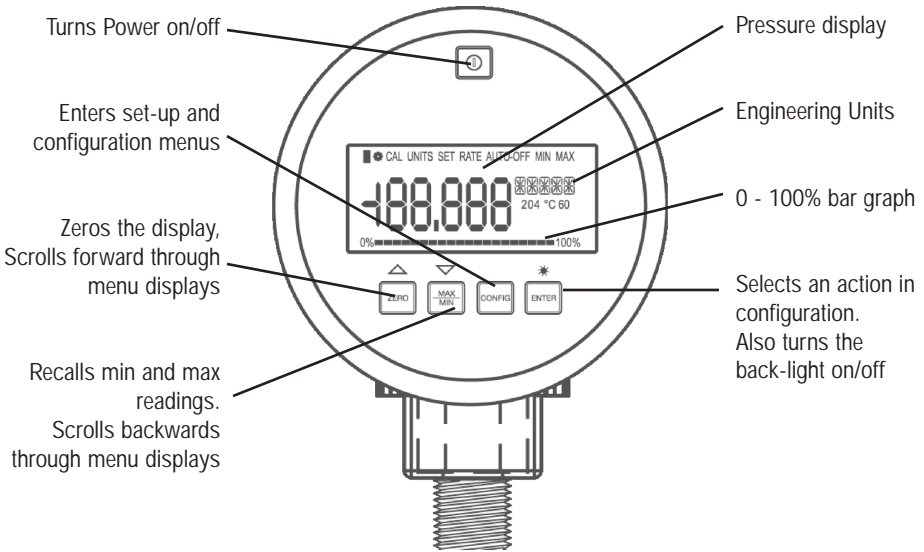

Operation

Power: The standard DPG4000 is supplied with 3 AA batteries installed. If you purchased the optional 24Volt powered version, batteries are not installed. Connect a 24V power supply to the terminal block on the rear of the gauge, noting proper polarity.

Do not install batteries when external power will be used.

Push the power button momentarily to turn the unit on. Push it again to turn it off.

Set-up and configuration:

Push the CONFIG button to access the user-settable functions on the gauge. Each time the CONFIG button is pressed; the display advances

to the next function. Once a function has been set, press ENTER to exit the configuration menu, or CONFIG to continue with further configuration. In order, the configuration menu and operation is as follows:

1. **Engineering Units set.** The unit is shipped configured to display PSI. By pressing the ▲ and ▼ (ZERO and MAX/MIN) keys you can scroll forward and backwards through the 18 standard engineering units plus a one custom unit/scale. When the desired unit is displayed, press ENTER or CONFIG. Pressure will now be displayed in the chosen engineering units.

See the Specifications section of this manual for a list of available engineering units. See the Supervisory Mode section for details on setting up custom units.

2. **Set Auto Off.** The auto-shut off can be set in 1 minute increments from 1 to 30 minutes or "off" (continuous operation). The unit is shipped set for 30 minutes. Use the ▲ and ▼ keys to set the desired interval. The "off" setting is at the low end of the choices, below 1 minute.
3. **Display battery voltage.** Actual voltage and a percent of life bargraph indicate battery condition
4. **Display actual temperature.** The DPG4000 is temperature compensated, this displays the temperature measured by the internal sensor. The value can be set to degrees F or degrees C using the arrow keys.
5. **Set damping.** Choices are "on" and "off" set with the ▲ and ▼ keys. Turning damping on will smooth readings from pulsating pressure sources.
6. **Set sample rate:** This determines how often pressure is sampled and the display is updated. Choices are 0.5, 1, 3, and 10 samples/second. Note that 10/sec provides the fastest response time.
7. **Set TARE.** This allows you to set a constant offset value, which is then subtracted from the measured pressure. For example if a TARE is set at 30 PSI, and the measured pressure is 37 PSI, the displayed value will be 7 PSI.
A pressure of 27 PSI would be displayed as -3 PSI.

The tare value is set manually with the ▲ and ▼ keys, and is based on the engineering units and resolution selected for display. TARE value can be set to the maximum range of the gauge.

The bar graph will always display the actual pressure based on the full range of the gauge regardless of the tare setting. This is done

for safety to insure that even with a "0" reading that pressure is being applied to the gauge.

8. **Function Lock:** Access to each of the settable parameters above can be turned "off" once set, to prevent unauthorized changes to configuration. This is accomplished through a password protected "supervisory mode". Press ENTER to access the supervisory mode, or CONFIG to return to normal operation.

Supervisory Mode

Press ENTER when "FUnC LOCK" is displayed, 0PWRD will be displayed on the gauge. The password to enter supervisory mode is 101, set using the ▲ and ▼ keys. Holding a key continuously will cause the display to advance more quickly for faster setting. The password is factory set and cannot be changed

1. Your DPG4000 is shipped from the factory with all setting access "unlocked" or available to be changed.
2. In supervisory mode each of the parameters can be locked or unlocked using the ▲ and ▼ keys. Select LOC (lock) for those parameters you do not want to be accessible, and UnLOC (unlock) for those can be accessed.
3. In order, the functions that can be unlocked, locked or accessed are:
 - Zero function (enable/disable)
 - Set pressure units (enable/disable)
 - Auto shutdown adjustment (enable/disable)
 - Damping settings (enable/disable)
 - Sample rate setting (enable/disable)
 - Tare setting (enable/disable)
 - Custom engineering units (set scale factor)
4. Use the CONFIG key to scroll through the above choices, and the ▲ and ▼ keys to lock and unlock features. Press CONFIG to continue scrolling through the parameters, pressing ENTER at any point saves your settings and returns the gauge to normal operation.

When a function is "locked, it cannot be accessed or changed from its current state. To change a locked function, enter the supervisory mode, and unlock the function. Once it is changed, you may enter supervisory mode to lock access again.

5. Setting a custom engineering unit or scale: The last menu choice in supervisory mode is SET FACTR. This allows you to set a multiplier factor from 0.001 to 100, creating a custom scale. The

set factor will be multiplied by the PSI measured, the result will be displayed.

For example: 40 PSI is the equivalent of 1000 lbs of product in a tank. You want to display the product weight, using a 100 PSI gauge. By setting a factor of 25, a 40 PSI pressure would display as 1000 (40 x 25). The engineering unit displayed on the DPG4000 will be "Cust".

Normal Operation

Turning the backlight on and off: Press the ENTER button.

Zeroing the display: Press and hold the ZERO button.

MAX/MIN: The DPG4000 stores minimum and maximum pressure values in memory. Pressing the MAX/MIN button once will display the minimum pressure from memory. Pressing the MAX/MIN button again will display the maximum pressure from memory. After about 2 seconds, the gauge returns to normal (live display) operation. To clear the MAX/MIN memory registers, press and hold the MAX/MIN button for 2 or more seconds until "CLr" is displayed.

The analog bar graph at the bottom of the display indicates the applied pressure level relative to the full range of the gauge. Keep in mind that if a TARE value has been programmed into the gauge, the displayed pressure will not reflect the true pressure applied.

Changing the Batteries



Explosion hazard

Batteries must only be changed in an area known to be non-hazardous.

Grasp the face ring on the DPG4000, turn it approximately ¼ turn counterclockwise and remove. The face of the gauge can now be lifted to expose the battery holder. Take off the battery hold clip and remove the batteries. Install three AA batteries noting proper polarity. Note: Use **ONLY** AA size batteries and be sure to reinstall the battery holder retaining clip. Reassemble the case making certain that the face is properly oriented.

If you purchased the optional 24 Volt powered version, the terminals for power input are located on the rear of the gauge. To apply power simply connect 24 volts to the rear terminal block taking care to observe proper polarity.



Gauges ordered with the external power option will not come with batteries installed. Batteries **MUST NOT** be installed when operating on external power. External power option gauges are not approved for hazardous location use.

Battery life

Battery life is about 1500 hours (60 days) of continuous use with the backlight off. With intermittent use, batteries could last a year or more. There is a low battery icon in the upper left of the display. It will appear when battery level is low. Replace batteries per recommendations found in the specifications section of this manual.

RS-232 Interface

An RS-232 interface is standard on the DPG4000. Serial communication can be used for configuration, calibration, and to transfer measurement data from the gauge. For detailed specifications on the interface and software communication, see pages 14 and 15 in this manual.



The RS-232 interface must not be used in hazardous areas.

CLEANING

To clean the DPG4000 use a cloth with a mild cleaning solution.

Specifications

All specifications cover the temperature range from 0°C to +50°C, unless otherwise noted.

Available Input Ranges

See page 13 for a table of available ranges in PSI plus equivalent ranges and resolution for all engineering units

Accuracy

Positive Pressure: $\pm 0.05\%$ FS

Vacuum: $\pm 0.25\%$ FS (500 PSI gauge ranges and below)
0.1% FS for 15/30 PSI compound/vacuum versions

For gauges with full scale ranges equal to, or less than 30 psi (2 BAR), vacuum operation is limited to -5psi (-350 mBAR). The exceptions are the 2 compound ranges; -15 to 15 PSI and -15 to 30 PSI.

Over Pressure Protection:

See table of Ranges and Resolutions.

Temperature Compensation

0°C to +50°C (32°F to +122°F) to rated accuracy

Note: For temperatures from -10 °C to 0 °C and 50 °C to 55 °C add .005% F.S./°C

Standard Engineering Units

PSI, Bar, kg/cm², inH₂O (4°C, 20°C or 60°F),

ftH₂O (4°C, 20°C or 60°F), cmH₂O (4 °C and 20 °C), mH₂O (4°C and 20°C), KPa, mBAR, inHg, mmHg, Torr

One custom unit (user programmable)

Media Compatibility

All ranges except 1 PSI and compound ranges:

Liquids and gases compatible with 316 stainless steel

1 PSI and compound ranges: clean, dry, non-corrosive gas

Environmental

Operating Temperature -10 °C to +55 °C

Storage -20 °C to +70 °C (-4 °F to +158 °F)

Humidity 10% to 95% RH Non-condensing

Pollution Degree II

Mechanical

Dimensions 4.5" (diameter) x 2.2" (depth) x 5" (height)

Pressure Connection: ¼" NPT Male

Housing: Stainless steel, meets NEMA 4/IP65

Display

5-1/2 Digits, 0.65" (16.53 mm) high

20-Segment bar graph, 0 to 100%

Power

Battery three (3), size AA alkaline batteries, optional 24 VDC power.

Battery Life 1,500 hours without backlight

2,000 hours at slow sample rate

Low Battery Indicator icon is displayed near the end of battery life

Appendix 1: DPG4000 Calibration Procedure

Overview

Calibration adjustment of the DPG4000 is performed electronically via internal software with the case closed. There are no mechanical adjustments; all calibration commands and adjustments are done via the keypad, using the display to guide the user through the calibration process.

Eight calibration points are used in the adjustment program, working from full scale to zero at pressures equaling 100%, 87.5%, 75%, 62.5%, 50%, 37.5%, 25%, 12.5%, and 0% of full scale plus vacuum.

Note: This is an ambient temperature calibration, and should be performed at an ambient temperature of $23^{\circ}\text{C} \pm 3^{\circ}\text{C}$ ($72^{\circ}\text{F} \pm 5^{\circ}\text{F}$). Calibration outside this temperature range will invalidate the temperature compensation program in the DPG4000.

Calibration Interval

You should check performance of the DPG4000 at the interval required by your calibration program. We recommend adjustment when measurement deviates by more than 75% of the specified accuracy, or 0.04%

Test Equipment

Verification and calibration of the DPG4000 requires pressure and/or vacuum standards able to produce and indicate pressures from vacuum to the full-scale range of the unit under test. In order to maintain the specified accuracy of the DPG4000, standards should have a TUR of 4:1 or better.

Connections:

The DPG4000 uses a 1/4 NPT male connection in the pressure input port. Various adapters may or may not be needed to connect to the pressure standard. Always make sure the hose, tubing, and fittings etc have a rated working pressure at or above the pressure of the unit. Also it is important that there be no leaks when performing calibration; use Teflon tape where appropriate.

Entering Calibration Mode:

After you have made your connections, turn the power on while holding the CONFIG key. Use the arrow keys to enter the password. The password is 101. If you have entered calibration mode correctly the display should look as shown below. The pressure value displayed will be the full-scale value of the gauge.

Procedure:

Screens shown in this manual represent the displays shown with a 500 psi Gauge. The DPG4000 will prompt the technician for the appropriate pressure at each calibration point.

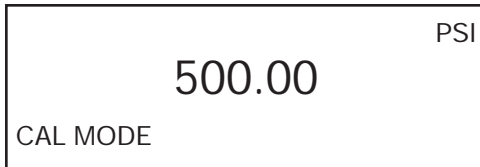

Use the Pressure Standard to output 500.00 psi (100%). After the output has stabilized, press the ENTER key to continue. As the unit takes readings, the screen will show -----. When the readings are complete the screen should look as shown in the illustration that follows.

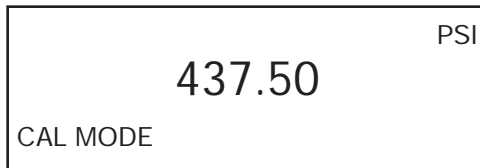

Use the Pressure Standard to output 437.50 psi (87.5%). After the output has stabilized, press the ENTER key to continue. As the unit takes readings, the screen will show -----. When the readings are complete the screen should look as shown below.

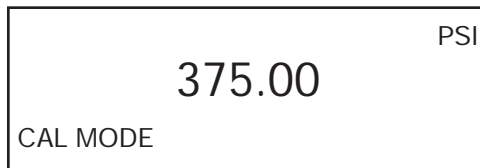

Use the Pressure Standard to output 375.00 psi (75%). After the output has stabilized, press the ENTER key to continue. As the unit takes readings, the screen will show -----. When the readings are complete the screen should look as shown below.

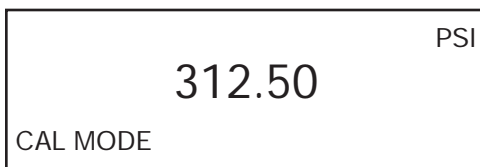

Use the Pressure Standard to output 312.50 psi (62.5%). After the output has stabilized, press the ENTER key to continue. As the unit takes readings, the screen will show ------. When the readings are complete the screen should look as shown below.

	PSI
250.00	
CAL MODE	

Use the Pressure Standard to output 250.00 psi (50%). After the output has stabilized, press the ENTER key to continue. As the unit takes readings, the screen will show ------. When the readings are complete the screen should look as shown below.

	PSI
187.50	
CAL MODE	

Use the Pressure Standard to output 187.50 psi (37.5%). After the output has stabilized, press the ENTER key to continue. As the unit takes readings, the screen will show ------. When the readings are complete the screen should look as shown below.

	PSI
125.00	
CAL MODE	

Use the Pressure Standard to output 125.00 psi (25%). After the output has stabilized, press the ENTER key to continue. As the unit takes readings, the screen will show ------. When the readings are complete the screen should look as shown below.

	PSI
62.50	
CAL MODE	

Use the Pressure Standard to output 62.50 psi (12.5%). After the output has stabilized, press the ENTER key to continue. As the unit takes readings, the screen will show ------. When the readings are complete the screen should look as shown below.

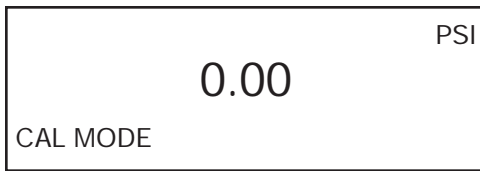

Use the Pressure Standard to output 0.00 psi. After the output has stabilized, press the ENTER key to continue. As the unit takes readings, the screen will show ———-. When the readings are complete the screen should look as shown below.

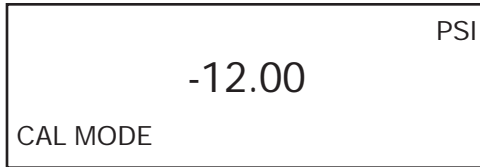

Note: Only some ranges use vacuum calibration. If your gauge is not one, than this step will be automatically skipped and calibration will be complete.

Use the Pressure Standard to output -12.00 psi. After the output has stabilized, press the ENTER key to continue. As the unit takes readings, the screen will show ———-. When the readings are complete the unit will reset and power up in normal mode.

Available Ranges and Resolution by Engineering Unit

Engineering Unit	Factor	1	15 ⁻¹	30 ²	100	300	500	1000	2000	3000	5000	10000
Burst Pressure		50	500	500	1000	2000	2000	10000	10000	10000	10000	15000
Proof Pressure		5	30	60	200	600	1000	2000	3000	6000	10000	15000
psi	1	1.0000	15.000	30.000	100.00	300.00	500.00	1000.0	2000.0	3000.0	5000.0	10000
bar	0.06894747	0.0689	1.0342	2.0684	6.8947	20.684	34.474	68.947	137.89	206.84	344.74	689.47
mbar	68.94757	68.948	1034.2	2068.4	6894.8	20684	34474	68948	*	*	*	*
kPa	6.894757	6.8948	103.42	206.84	689.48	2068.4	3447.4	6894.8	13790	20684	34474	68948
Mpa	0.0068947	0.0069	0.1034	0.2068	0.6895	2.0684	3.4474	6.8947	13.789	20.684	34.474	68.947
kg/cm ²	0.07030697	0.0703	1.0546	2.1092	7.0307	21.092	35.153	70.307	140.61	210.92	351.53	703.07
mmHg @ 0°C	51.71508	51.715	775.73	1551.5	5171.5	15515	25858	51715	*	*	*	*
inHg @ 0°C	2.03602	2.0360	30.540	61.081	203.60	610.81	1018.0	2036.0	4072.0	6108.1	10180	20360
cmH ₂ O @ 4°C	70.3089	70.309	1054.6	2109.3	7030.9	21093	35154	70309	*	*	*	*
cmH ₂ O @ 20°C	70.4336	70.434	1056.5	2113.0	7043.4	21130	35217	70434	*	*	*	*
mH ₂ O @ 4°C	0.703089	0.7031	10.546	21.093	70.309	210.93	351.54	703.09	1406.2	2109.3	3515.4	7030.9
mH ₂ O @ 20°C	0.704336	0.7043	10.565	21.130	70.434	211.30	352.17	704.34	1408.7	2113.0	3521.7	7043.4
inH ₂ O @ 4°C	27.68067	27.681	415.21	830.42	2768.1	8304.2	13840	27681	55361	83042	*	*
inH ₂ O @ 20°C	27.72977	27.730	415.95	831.89	2773.0	8318.9	13865	27730	55460	83189	*	*
inH ₂ O @ 60°F	27.70759	27.708	415.61	831.23	2770.8	8312.3	13854	27708	55415	83123	*	*
ftH ₂ O @ 4°C	2.306726	2.3067	34.601	69.202	230.67	692.02	1153.4	2306.7	4613.5	6920.2	11534	23067
ftH ₂ O @ 20°C	2.310814	2.3108	34.662	69.324	231.08	693.24	1155.4	2310.8	4621.6	6932.4	11554	23108
ftH ₂ O @ 60°F	2.308966	2.3090	34.634	69.269	230.90	692.69	1154.5	2309.0	4617.9	6926.9	11545	23090
ft Sea Water	2.247	2.2470	33.705	67.410	224.70	674.10	1123.5	2247.0	4494.0	6741.0	11235	22470
M Sea Water	0.6849	0.6849	10.274	20.547	68.490	205.47	342.45	684.90	1369.8	2054.7	3424.5	6849.0
Torr	51.71508	51.715	775.73	1551.5	5171.5	15515	25858	51715	*	*	*	*

1. Also applies to -15 to +15 PSI compound range.

2. Also applies to -15 to +30 PSI compound range.

3. Cells noted with * will not be displayed due to limitations on display resolution. In all cases, resolution is limited to 100,000 counts.

DPG4000 Serial Interface Instructions

Initiating Communication

The terminal communications can be setup using terminal communication software on a PC. The terminal settings need to be set as follows:

- Bits per second: 9600
- Data bits: 8
- Parity: None
- Stop bits: 1
- Flow control: None
- Local echo on

List of Commands

Command	Description
CAL_START	Puts the calibrator in calibration mode
*CLS	Clears the error queue.
FAULT?	Returns an error code from the error queue
*IDN?	Identification query. Returns the manufacturer, model number, and firmware revision level of the Calibrator.
TARE	Tares the offset pressure of the reading on the calibrator
TARE?	Returns the current tare value
PRES_UNIT?	Returns the pressure unit for the upper display.
PRES_UNIT	Sets the pressure unit for the display
ZERO_MEAS	Zeros pressure of the calibrator
ZERO_MEAS?	Returns the current zero offset value
MINMAX_RST	Resets the minimum and maximum recorded values.
MIN?	Returns the minimum recorded value
MAX?	Returns the maximum recorded value
HC_OFF	Turns unit off
HC_DFLT	Sets auto off defaults
TEMP?	Returns temperature in the chosen units
HC_COMP_OFF	Turns temperature compensation off.
HC_COMP_ON	Turns temperature compensation on.
HC_COMP?	Returns state of temperature compensation.
HC_RD_2410?	Return 2410 ADC counts.
HC_SI_OFF	Turns SI mode off.
HC_SI_ON	Turns SI mode on.

CAL_STORE	Stores calibration data.
HC_AUTO_OFF	Turns auto shutdown off
HC_AUTO_ON	Turns auto shutdown on
CUST_MULT?	Sets the multiplier for the custom unit type
STREAM_OFF	Turns streaming data off
STREAM_ON	Turns streaming data on
HC_TEMP?	Same as TEMP?
VAL?	Returns the measured pressure value in selected units
HC_CMD_LIST	Prints out a command list
TEMP_UNIT	Used to set temperature unit
TEMP_UNIT?	Returns temperature unit

Parameter Units

Units	Meaning
Psi	Pressure in pounds per square-inch
Bar	Pressure in bars
mBar	Pressure in millibars
Kg/cm2	Pressure in kilograms per centimeter squared
InH2O4C	Pressure in inches of water at 4°C
InH2O20C	Pressure in inches of water at 20°C
InH2O60F	Pressure in inches of water at 60°F
mH2O4C	Pressure in meters of water at 4°C
MH2O20C	Pressure in meters of water at 20°C
cmH2O4C	Pressure in centimeters of water at 4°C
cmH2O4C	Pressure in centimeters of water at 20°C
ftH2O4C	Pressure in feet of water at 4°C
ftH2O20C	Pressure in feet of water at 20°C
ftH2O60F	Pressure in feet of water at 60°F
Inhg0C	Pressure in inches of mercury at 0°C
mmhg0C	Pressure in millimeters of mercury at 0°C
kpal	Pressure in kilopascals
Far	Temperature in Farenhiet
Cel	Temperature in Celcius

Error Codes

Error	Description
101	A non-numeric entry was received where it should be a numeric entry
102	Too many significant digits entered
103	Invalid units or parameter value received
105	Entry is above the upper limit of the allowable range
106	Entry is below the lower limit of the allowable range
108	A required command parameter was missing
109	An invalid pressure unit was received
117	An unknown command was received
120	The serial input buffer overflowed
121	Too many entries in the command line
122	Pressure module not connected

WARRANTY/DISCLAIMER

OMEGA ENGINEERING, INC. warrants this unit to be free of defects in materials and workmanship for a period of 13 months from date of purchase. OMEGA's Warranty adds an additional one (1) month grace period to the normal one (1) year product warranty to cover handling and shipping time. This ensures that OMEGA's customers receive maximum coverage on each product.

If the unit malfunctions, it must be returned to the factory for evaluation. OMEGA's Customer Service Department will issue an Authorized Return (AR) number immediately upon phone or written request. Upon examination by OMEGA, if the unit is found to be defective, it will be repaired or replaced at no charge. OMEGA's WARRANTY does not apply to defects resulting from any action of the purchaser, including but not limited to mishandling, improper interfacing, operation outside of design limits, improper repair, or unauthorized modification. This WARRANTY is VOID if the unit shows evidence of having been tampered with or shows evidence of having been damaged as a result of excessive corrosion; or current, heat, moisture or vibration; improper specification; misapplication; misuse or other operating conditions outside of OMEGA's control. Components which wear are not warranted, including but not limited to contact points, fuses, and triacs.

OMEGA is pleased to offer suggestions on the use of its various products. However, OMEGA neither assumes responsibility for any omissions or errors nor assumes liability for any damages that result from the use of its products in accordance with information provided by OMEGA, either verbal or written. OMEGA warrants only that the parts manufactured by it will be as specified and free of defects. OMEGA MAKES NO OTHER WARRANTIES OR REPRESENTATIONS OF ANY KIND WHATSOEVER, EXPRESS OR IMPLIED, EXCEPT THAT OF TITLE, AND ALL IMPLIED WARRANTIES INCLUDING ANY WARRANTY OF MERCHANTABILITY AND FITNESS FOR A PARTICULAR PURPOSE ARE HEREBY DISCLAIMED. LIMITATION OF LIABILITY: The remedies of purchaser set forth herein are exclusive, and the total liability of OMEGA with respect to this order, whether based on contract, warranty, negligence, indemnification, strict liability or otherwise, shall not exceed the purchase price of the component upon which liability is based. In no event shall OMEGA be liable for consequential, incidental or special damages.

CONDITIONS: Equipment sold by OMEGA is not intended to be used, nor shall it be used: (1) as a "Basic Component" under 10 CFR 21 (NRC), used in or with any nuclear installation or activity; or (2) in medical applications or used on humans. Should any Product(s) be used in or with any nuclear installation or activity, medical application, used on humans, or misused in any way, OMEGA assumes no responsibility as set forth in our basic WARRANTY/DISCLAIMER language, and, additionally, purchaser will indemnify OMEGA and hold OMEGA harmless from any liability or damage whatsoever arising out of the use of the Product(s) in such a manner.

RETURN REQUESTS/INQUIRIES

Direct all warranty and repair requests/inquiries to the OMEGA Customer Service Department. BEFORE RETURNING ANY PRODUCT(S) TO OMEGA, PURCHASER MUST OBTAIN AN AUTHORIZED RETURN (AR) NUMBER FROM OMEGA'S CUSTOMER SERVICE DEPARTMENT (IN ORDER TO AVOID PROCESSING DELAYS). The assigned AR number should then be marked on the outside of the return package and on any correspondence.

The purchaser is responsible for shipping charges, freight, insurance and proper packaging to prevent breakage in transit.

FOR WARRANTY RETURNS, please have the following information available BEFORE contacting OMEGA:

1. Purchase Order number under which the product was PURCHASED,
2. Model and serial number of the product under warranty, and
3. Repair instructions and/or specific problems relative to the product.

FOR NON-WARRANTY REPAIRS, consult OMEGA for current repair charges. Have the following information available BEFORE contacting OMEGA:

1. Purchase Order number to cover the COST of the repair,
2. Model and serial number of the product, and
3. Repair instructions and/or specific problems relative to the product.

OMEGA's policy is to make running changes, not model changes, whenever an improvement is possible. This affords our customers the latest in technology and engineering.

OMEGA is a registered trademark of OMEGA ENGINEERING, INC.

© Copyright 2004 OMEGA ENGINEERING, INC. All rights reserved. This document may not be copied, photocopied, reproduced, translated, or reduced to any electronic medium or machine-readable form, in whole or in part, without the prior written consent of OMEGA ENGINEERING, INC.

Where Do I Find Everything I Need for Process Measurement and Control? OMEGA...Of Course!

Shop online at www.omega.com

TEMPERATURE

- ☑ Thermocouple, RTD & Thermistor Probes, Connectors, Panels & Assemblies
- ☑ Wire: Thermocouple, RTD & Thermistor
- ☑ Calibrators & Ice Point References
- ☑ Recorders, Controllers & Process Monitors
- ☑ Infrared Pyrometers

PRESSURE, STRAIN AND FORCE

- ☑ Transducers & Strain Gages
- ☑ Load Cells & Pressure Gages
- ☑ Displacement Transducers
- ☑ Instrumentation & Accessories

FLOW/LEVEL

- ☑ Rotameters, Gas Mass Flowmeters & Flow Computers
- ☑ Air Velocity Indicators
- ☑ Turbine/Paddlewheel Systems
- ☑ Totalizers & Batch Controllers

pH/CONDUCTIVITY

- ☑ pH Electrodes, Testers & Accessories
- ☑ Benchtop/Laboratory Meters
- ☑ Controllers, Calibrators, Simulators & Pumps
- ☑ Industrial pH & Conductivity Equipment

DATA ACQUISITION

- ☑ Data Acquisition & Engineering Software
- ☑ Communications-Based Acquisition Systems
- ☑ Plug-in Cards for Apple, IBM & Compatibles
- ☑ Datalogging Systems
- ☑ Recorders, Printers & Plotters

HEATERS

- ☑ Heating Cable
- ☑ Cartridge & Strip Heaters
- ☑ Immersion & Band Heaters
- ☑ Flexible Heaters
- ☑ Laboratory Heaters

ENVIRONMENTAL MONITORING AND CONTROL

- ☑ Metering & Control Instrumentation
- ☑ Refractometers
- ☑ Pumps & Tubing
- ☑ Air, Soil & Water Monitors
- ☑ Industrial Water & Wastewater Treatment
- ☑ pH, Conductivity & Dissolved Oxygen Instruments