

CE

MADE
IN
USA

User's Guide

Shop on line at

omega.com[®]

Ω OMEGA[®]

www.omega.com

e-mail: info@omega.com



DP41-B Series
Serial Communication Option



OMEGAnet® On-Line Service www.omega.com	Internet e-mail info@omega.com
--	--

Servicing North America:

USA: One Omega Drive, P.O. Box 4047
ISO 9001 Certified Stamford CT 06907-0047
TEL: (203) 359-1660 FAX: (203) 359-7700
e-mail: info@omega.com

Canada: 976 Bergar
Laval (Quebec) H7L 5A1
TEL: (514) 856-6928 FAX: (514) 856-6886
e-mail: info@omega.ca

For immediate technical or application assistance:

USA and Canada: Sales Service: 1-800-826-6342 / 1-800-TC-OMEGA®
Customer Service: 1-800-622-2378 / 1-800-BEST®
Engineering Service: 1-800-872-9436 / 1-800-USA-WHEN®

Mexico and Latin America: TEL: (001)800-TC-OMEGA® FAX: (001) 203-359-7807
En Español: (001) 203-359-7803
e-mail: espanol@omega.com

Servicing Europe:

Benelux: Postbus 8034, 1180 LA Amstelveen, The Netherlands
TEL: +31 20 3472121 FAX: +31 20 6434643
Toll Free in Benelux: 0800 0993344
e-mail: sales@omegaeng.nl

Czech Republic: Frystatska 184, 733 01 Karviná
TEL: +420 59 6311899 FAX: +420 59 6311114
e-mail: info@omegashop.cz

France: 11, rue Jacques Cartier, 78280 Guyancourt
TEL: +33 1 61 37 29 00 FAX: +33 1 30 57 54 27
Toll Free in France: 0800 466 342
e-mail: sales@omega.fr

Germany/Austria: Daimlerstrasse 26, D-75392 Deckenpfronn, Germany
TEL: +49 7056 9398-0 FAX: +49 7056 9398-29
Toll Free in Germany: 0800 639 7678
e-mail: info@omega.de

United Kingdom: One Omega Drive
ISO 9002 Certified River Bend Technology Centre
Northbank, Irlam Manchester M44 5BD United Kingdom
TEL: +44 161 777 6611 FAX: +44 161 777 6622
Toll Free in England: 0800 488 488
e-mail: sales@omega.co.uk

It is the policy of OMEGA to comply with all worldwide safety and EMC/EMI regulations that apply. OMEGA is constantly pursuing certification of its products to the European New Approach Directives. OMEGA will add the CE mark to every appropriate device upon certification.

The information contained in this document is believed to be correct but OMEGA Engineering, Inc. accepts no liability for any errors it contains, and reserves the right to alter specifications without notice.

WARNING: These products are not designed for use in, and should not be used for, patient connected applications.

 This device is marked with the international hazard symbol. It is important to read the Setup Guide before installing or commissioning this device as it contains important information relating to safety and EMC.

Table of Contents

SECTION 1 INTRODUCTION	1-1
SECTION 2 HARDWARE	2-1
2.1 Definition of terms.....	2-1
2.2 RS-232 and RS-485 hardware	2-1
SECTION 3 USING THE CONFIGURATION SETUP	3-1
SECTION 4 DEFINITIONS	4-1
4.1 Meter or DCE.....	4-1
4.2 Computer or DTE	4-1
4.3 Point to Point	4-1
4.4 Multi Point (Multi-Drop).....	4-1
4.5 Simplex.....	4-1
4.6 Half Duplex.....	4-1
4.7 Full Duplex.....	4-1
4.8 RS-232 (CCITT V.24)	4-2
4.9 RTS	4-2
4.10 RS-422	4-2
4.11 RS-485	4-2
4.12 ASCII	4-3
4.13 Hex ASCII.....	4-4
4.14 Transmission Voltage Levels.....	4-6
4.15 Recognition Character.....	4-6
4.16 RAM	4-6
4.17 EEPROM.....	4-6
SECTION 5 BAUD RATES	5-1
SECTION 6 CHARACTER WAVEFORM	5-1
SECTION 7 CLASSES OF OPERATION	7-1
7.1 Point to Point	7-1
7.1.1 Continuous Mode	7-1
7.1.1.1 Message Handshake	7-2
7.1.1.2 Character Handshake	7-2
7.1.2 Command Mode.....	7-2
7.2 Multi Point.....	7-2
7.2.1 Command Mode.....	7-2
7.2.2 Alarm Mode.....	7-3
7.3 The Meter as a Remote Display	7-4
7.4 The Meter as a Double Tasking Remote Meter	7-4
7.4.1 Command Structure for Double Tasking	7-5

Table of Contents

SECTION 8 COMMAND AND RESPONSE STRUCTURE	8-1
8.1 Message String.....	8-1
8.1.1 "Data" and "Non Data"	8-1
8.1.2 Brackets and Spaces	8-1
8.2 Commands and Structure.....	8-2
8.2.1 Read Communications Configuration Command	8-2
8.2.2 General Command Structure	8-3
8.2.3 Command Formats.....	8-4
8.2.4 Command Suffix	8-6
8.3 Response Structure	8-9
8.3.1 No Error.....	8-9
8.3.2 Echo Mode	8-9
8.3.3 No Echo Mode.....	8-9
8.4 Data Length Corresponding to the Response Structure	8-10
8.5 Error Response.....	8-11
8.5.1 Error Response Format	8-11
8.5.2 Error Message	8-11
8.5.3 Description	8-12
8.6 Status Character Formats	8-13
8.6.1 Alarm Status Characters	8-13
8.6.2 Peak/Valley (HI/LO) Status Characters	8-14
8.7 "VO1" Response Data Format.....	8-15
8.8 "^AE" Response Format.....	8-16
8.9 Examples	8-16
SECTION 9 METER BUS RESPONSE	9-1
9.1 Point to Point or Multi Point Command Mode.....	9-1
9.1.1 Meter's Response Time.....	9-2
9.2 Point to Point Continuous Mode	9-3
9.2.1 Meter's Response Time.....	9-3
9.2.2 Communicating with the Meter when in Continuous Mode	9-3
9.3 Multi Point Alarm Mode Response	9-4
9.4 Watchdog timer for communication	9-4
SECTION 10 DATA FORMAT COMMANDS (P, G, R, W)	10-1
10.1 Reading Configuration ("RdG.CNF")	10-2
10.2 Input Configuration ("INP.CNF" and "INPUT")	10-3
10.3 Setting Count By ("CNTby") and Decimal Point ("SEt dP").....	10-4
10.4 Filter Configuration ("FILtER" and "OUt.tyP").....	10-5
10.5 Setpoint 1 and 2 Configuration ("SP.CNF")	10-6
10.6 Alarm (Setpoints 3 and 4) Configuration ("AL.CNF").....	10-7
10.7 Alarm Functions ("AL.CNF and AL.MOdE").....	10-8
10.8 Alarm Delay: ("NUM.dLy")	10-8
10.9 Output Configuration ("OUt.CNF") and A to D Rate ("Ad.RAtE").....	10-9
10.10 Input Type ("INPUt") and Reading Scale & Offset ("Rd.SC.OF").....	10-10
10.11 Serial Communications Configuration ("COMM")	10-11
10.12 Data Format ("dAt.FMt")	10-12
10.13 Communications Bus Format ("bUS.FMt")	10-13
10.14 Lockout Configuration ("LCK.CNF").....	10-14
10.15 Lockout Configuration ("LCK.CNF") and Normal Color ("N.COLOR")....	10-15
10.16 Color Configuration ("COLOR")	10-16

Table of Contents

10.17	Block A.....	10-17
10.18	Block B	10-19
10.19	Block C	10-21
10.20	Block D	10-22
10.21	R/W44 (Block E)	10-23
10.22	R/W45 (Block F)	10-23
10.23	R46	10-23
10.24	R47	10-23
10.25	R48	10-23
10.26	R/W50	10-24
10.27	RW51,RW52,RW53,RW54,RW55,RW56,RW57,RW58 RW59 RW5A....	10-25
10.28	Set Sign and Decimal Point Format	10-26
10.29	RS-485 Meter “AddRES”	10-27
10.30	Number of Readings between each Transmission (“SER CNT”).....	10-27
10.31	Recognition Character (SER.RCG).....	10-28
10.32	Units of Measure (SER.UOM)	10-28
10.33	TX/RX Turnaround Delay (Serial Delay SER.dLy)	10-29
10.34	Reading, Input, or Output Scale Factor (“RdG SC”, “INP SC”, “OUt SC”)....	10-29
10.35	Reading Offset(“RdG OF”), Input Offset(“INP OF”), or Output Offset(“OUt OF”)..	10-31
10.36	Setpoint 1 and 2 Hysteresis (“SP db”)	10-32
10.37	Alarm (SP 3 and SP 4) Hysteresis (“AL db”)	10-32

Figure 2-1	RS-232 / RS-485 Option Board.....	2-1
Figure 2-2	Main Board with the RS-232/RS-485 Option Board	2-3
Figure 2-3	Rear of Meter with J4 connection	2-3
Figure 2-4A	RJ-11 to D9 Connector	2-4
Figure 2-4B	RJ-11 to D25 Connector.....	2-4
Figure 2-5	Multipoint, Half-Duplex RS-485 Connection	2-5
Figure 2-6	Multipoint Full-Duplex RS-485 Connection	2-6
Figure 6-1	Character Waveform	5-1

Table of Contents

Table 2.1	Meter Hookup (RS-232) to the Computer	2-4
Table 2.2	Meter Hookup (RS-232) to the Printer.....	2-4
Table 2.3	Half-Duplex Hookup (RS-485) to the Computer.....	2-5
Table 2.4	Full-Duplex Hookup to the Computer	2-6
Table 4.1	The ASCII Character Code.....	4-5
Table 4.2	Meter Receiving Voltages.....	4-6
Table 4.3	Meter Transmitting Voltages.....	4-6
Table 8.1	Command Prefix Letters (Command Classes).....	8-3
Table 8.2	Command Letters and Suffixes	8-6
Table 8.3	Error Messages	8-11
Table 8.4	Alarm Status Characters	8-13
Table 8.5	Peak/Valley Status Characters.....	8-14
Table 8.6	Special Characters	8-15
Table 9.1	Reading Rate for Command Mode.....	9-2
Table 9.2	Reading Rate for Communication	9-3
Table 10.1	Reading Configuration.....	10-2
Table 10.2	Input Configuration	10-3
Table 10.3	Count By and Decimal Point	10-4
Table 10.4	Filter Configuration and Output Type	10-5
Table 10.5	Setpoint Configuration.....	10-6
Table 10.6	Alarm Configuration	10-7
Table 10.7	Alarm Configuration and Mode	10-8
Table 10.8	Alarm Delay.....	10-8
Table 10.9	Output Configuration	10-9
Table 10.10	Input Type and Reading Scale and Offset.....	10-10
Table 10.11	Serial Communications Configuration	10-11
Table 10.12	Data Format	10-12
Table 10.13	Bus Format.....	10-13
Table 10.14	Lockout Configuration	10-14
Table 10.15	Lockout Configuration and Normal Color	10-15
Table 10.16	Color Configuration	10-16
Table 10.17	R/W40 (Block A)	10-17
Table 10.18	R/W41 (Block B).....	10-19
Table 10.19	R/W42 (Block C)	10-21
Table 10.20	R/W43 (Block D).....	10-22
Table 10.21	R/W44 (Block E).....	10-23
Table 10.22	R/W45 (Block F)	10-23
Table 10.23	R/W50	10-24
Table 10.24	R/W50 NUM.PNt and MENU selection	10-24
Table 10.25	R/W5XXXX	10-25
Table 10.26	Setpoint Values	10-26
Table 10.27	Serial Delay (“SER.dLy”)	10-29
Table 10.28	Reading Scale(“RdG SC”),Input Scale(“INP SC”),Output Scale(“OUt SC”).....	10-30
Table 10.29	Reading Offset(“RdG OF”),Input Offset(“INP OF”),Output Offset(“OUt OF”) ..	10-31

1. Introduction

This manual is intended to facilitate digital communication between your computer (or other controlling device) and one or more meters.

This digital-communications manual is provided for use with the meters' OWNER'S MANUAL, which provide details of all applicable inputs, connections, options, pushbutton controls and programming procedures.

Information that is especially important to note is identified by these labels:

- **NOTE**
- **WARNING**
- **CAUTION**
- **IMPORTANT**



NOTE: provides you with information that is important to successfully setup and use the Programmable Digital Meter.



CAUTION or WARNING: tells you about the risk of electric shock.



CAUTION, WARNING or IMPORTANT: tells you of circumstances or practices that can effect the meter's functionality and must refer to accompanying documents.

Customer Service

If you need assistance, please call the nearest Customer Service Department, listed in this manual.

Manuals, Software

The latest Operation and Communication Manual as well as free configuration software and ActiveX controls are available from **the website listed in this manual or on the CD-ROM enclosed with your shipment.**

Communication Menu

The Communication menu only appears with devices purchased with the RS-232C / RS-485 Serial Communications Option. Purchasing the controller with Serial Communications permits a controller to be connected directly to the PC's available COM port. Device can be configured or monitored from an IBM PC compatible computer using software available on our CD or on our website.

2. Hardware

2.1 DEFINITION OF TERMS

RX:	Received line on RS-232
TX:	Transmit line on RS-232
RTS:	Request to send
+RX:	First pair received line on RS-422/485
+TX:	First pair transmit line on RS-422/485
-RX:	Second pair received line on RS-422/485
-TX:	Second pair transmit line on RS-422/485
RTN:	Ground/Return

2.2 RS-232 AND RS-485 HARDWARE

INSTALLATION: The RS-232/485 card is approximately 1" high and 5" long. It is installed with the meter removed from its case (Refer to **Section 5** of your meter's Owner's Guide for instructions on how to open the meter). P11 inserts into J11 of the main board located next to the transformer (Refer to **Figure 2-2**). The board is held in position by a plastic guide on the rear of the display board and plastic assembly at the rear of the meter. The 6-pin telephone jack, J4, is available at the rear of the meter case, and accepts a type RJ-11 or RJ-12 telephone plug (Refer to **Figure 2-3**).

Logic signals are opto-isolated, and drive power is obtained from a galvanically-isolated transformer winding so that the ± 7 V signal levels from the meter can be slaved to the external controller (computer) ground; earthing that ground is recommended.

2. Hardware

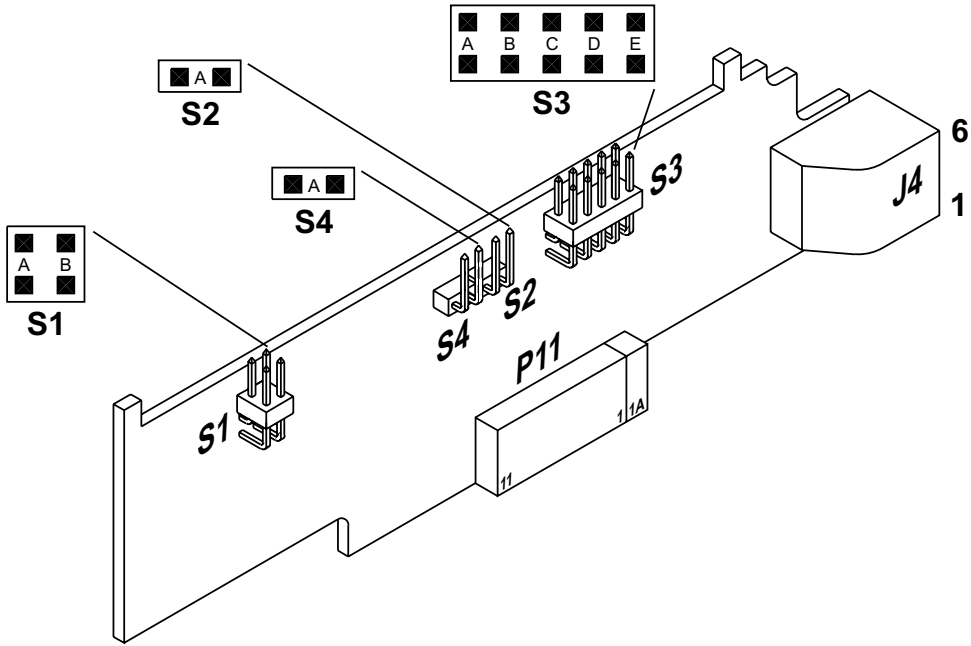

Figure 2-1. RS-232 / RS-485 Option Board

Note You should install the option board in such a way the pin “1A” of “P11” is aligned with pin “1A” of “J11” (on main board, refer to **Figure 2-2**).

When interfacing the meter to devices that do not have handshaking lines, i.e. RTS/CTS, the S3-E Jumper should be installed. However, when interfacing to a PC, the S3-E should be removed.

JUMPER	RS232	RS485 HALF DUPLEX	RS485 FULL DUPLEX
S1-A	CLOSE	OPEN	OPEN
S1-B	OPEN	CLOSE	OPEN
S2-A	OPEN	CLOSE	CLOSE
S3-A (CLOSE FOR TERMINAL RESISTOR)	OPEN	*	*
S3-B	OPEN	CLOSE	OPEN
S3-C (CLOSE FOR TERMINAL RESISTOR)	OPEN	*	*
S3-D	OPEN	CLOSE	OPEN
S3-E (CLOSE FOR RTS TRUE)	*	OPEN	OPEN
S4 (CLOSE FOR CONTINUOUS MODE)	OPEN	*	*

Note: * means optional, select as required.

2. Hardware

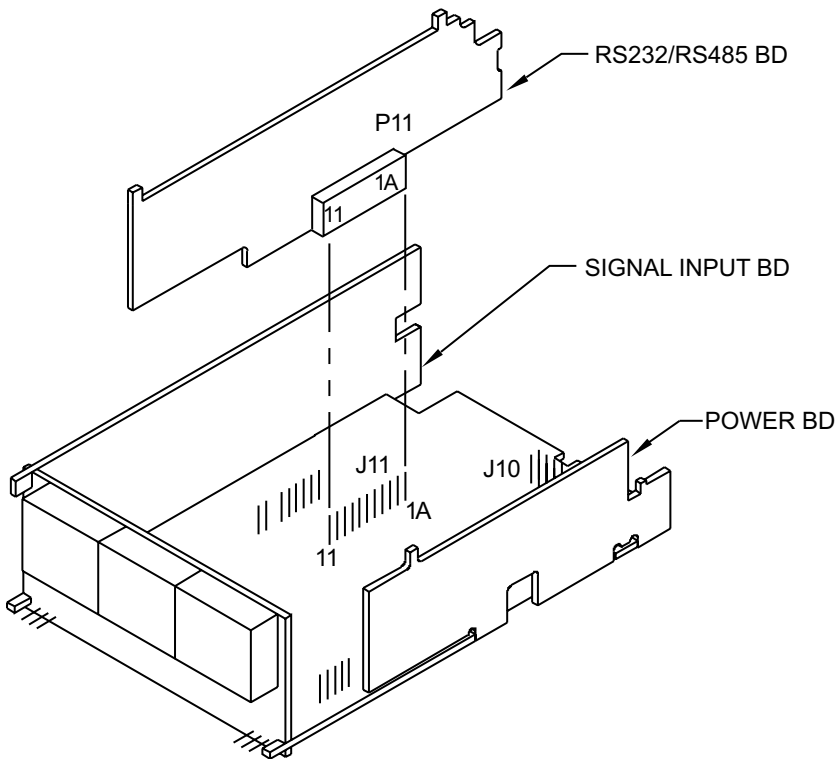

Figure 2-2. Main Board with the RS-232/RS-485 Option Board

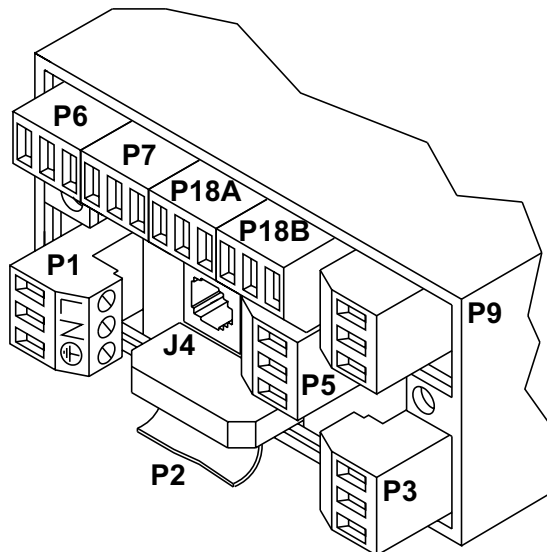

Figure 2-3. Rear of Meter with J4 connection.

2. Hardware

Figures 2-4A and Figure 2-4B show the four-wire RS-232 connections between the host computer/controller using either a 9-pin or 25-pin “D” connector and the meter (point-to-point full duplex, with RTS handshake).

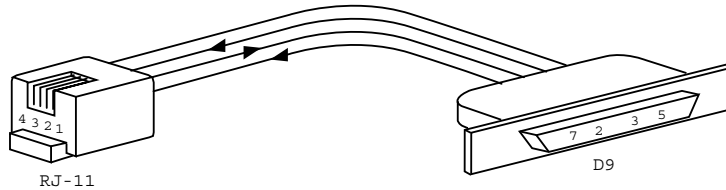

Figure 2-4A. RJ-11 to D9 Connector

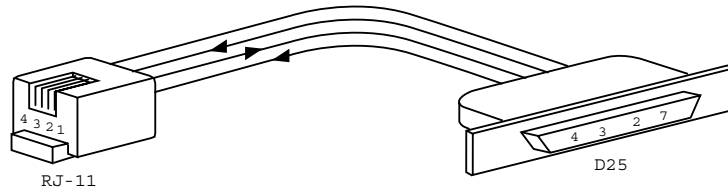

Figure 2-4B. RJ-11 to D25 Connector

Table 2.1 shows the pin connection assignments between the RS-232 connection on the meter and the 9-pin or 25-pin “D” connectors of your computer.

Table 2.1. Meter Hookup (RS-232) to the Computer

PIN SIGNAL/FUNCTION	METER (DCE)		COMPUTER (DTE)	
	RJ-11	RJ-12	D9	D25
RTS, meter from computer	1	2	7	4
TX, meter = RX, computer	2	3	2	3
RX, meter = TX, computer	3	4	3	2
Return	4	5	5	7
NC (not connected)		1,6	(all others)	

Table 2.2 shows the pin connection assignments between the RS-232 connection on the meter and the 9-pin or 25-pin “D” connectors of your printer.

Table 2.2. Meter Hookup (RS-232) to the Printer

PIN SIGNAL/FUNCTION	METER		PRINTER FUNCTIONS
	RJ-11	RJ-12	
RTS, meter	1	2	Data Terminal Ready (DTR)
TX, meter	2	3	Received Data (RXD)
RX, meter	3	4	Not Connected
Return	4	5	Signal Return
NC (not connected)		1,6	

2. Hardware

Logic symbols are opto-isolated, and drive power is obtained from a galvanically-isolated transformer winding so that the differential signals (minimum ± 2 V) will not be altered by an external ground; earthing of the external transceiver power supply is recommended to limit common-mode voltage.

The RS-485 hardware may be operated point-to-point (e.g., as RS-422 equipment), OR in multipoint, sharing the bus wires with up to 32 other meters.

The RS-485 cabling may be a single pair of wires (usually with a shield) for HALF DUPLEX (**Figure 2-5**), or two such pairs for FULL DUPLEX (**Figure 2-6**). The configurations shown are for bus operation, with tap-offs for each meter.

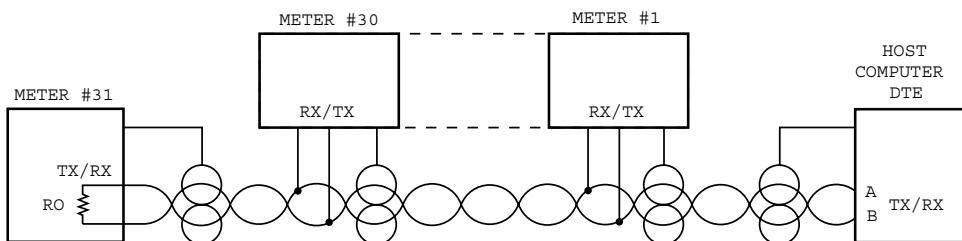

Figure 2-5. Multipoint, Half-Duplex RS-485 Connection

Table 2.3. Half-Duplex Hookup (RS-485) to the Computer

PIN SIGNAL/FUNCTION	METER (DCE) RJ-12	COMPUTER (DTE) D9/D25
RX	2	(SEE MFG DWG)
TX	3	(SEE MFG DWG)
RTN	5	(SEE MFG DWG)

RS-422/RS-485 multipoint interconnections between the computer (DTE) and the meter (DCE) are less well defined because different computer/controller manufacturers use different pins on their D9 or D25 connectors.

2. Hardware

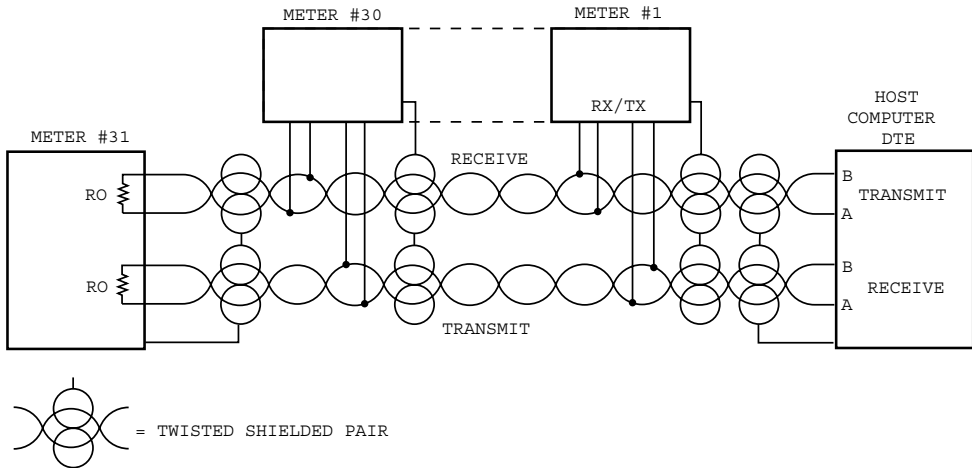

Figure 2-6. Multipoint Full-Duplex RS-485 Connection

Table 2.4. Full-Duplex Hookup to the Computer

PIN SIGNAL/FUNCTION	METER (DCE) RJ-12	COMPUTER (DTE) D9/D25
+TX	1	(SEE MFG DWG)
-TX	3	(SEE MFG DWG)
+RX	2	(SEE MFG DWG)
-RX	4	(SEE MFG DWG)
RTN	5	(SEE MFG DWG)
NC (not connected)	6	

Both HALF DUPLEX (**Figure 2-5**) and FULL DUPLEX RS-485 (**Figure 2-6**) communications require a 6-wire RJ-12 plug to be connected to the RJ-12 jack at the rear of the meter.

Unlike RS-232, there presently is no established standard D9 or D25 connector pin-out for RS-485; refer to your computer or controller manual to insure the right cable connections.



If communications with your meter has failed, it is recommended that you check for the receive portion of the RS-485 board on DTE (computer). These lines should be pulled up for +RX and pulled down for -RX with resistors with a resistance value from 330 ohms to 1K ohms.

3. Using The Configuration Setup

The Configuration software is simple to use for both the new style (**INF-B**) and the legacy ones (**INFP, INFS, INFT** and **INFU**), based on your selection. It is able to read or write the configuration to a device through Serial or TCP/IP communication and displays corresponding jumper settings of the device i.e. hardware configuration.

If the communication link is in place, no more pushbutton programming is needed: the computer takes over at this point. Follow the prompts and selections on that screen.

The Infinity configuration program allows the configuration the **INF-B, INFP, INFS, INFT** and **INFU** devices.

The program does not read the device model (e.g. **INF-B, INFU**, etc). Before reading or writing a configuration to a device, the correct device model has to be specified.

The program has a configuration file, named **InfinityConfiguration.inb**, which saves all the program settings when the program is shut down. The next time that the program is started, the program goes to the configuration file, **InfinityConfiguration.inb**, reads all the settings and loads them to the program.

Help files are available. Select an item and click the **F1** key to open the help files.

The program was designed to create a configuration as soon as the program is opened or read or write a device configuration. There is no defined borderline. If writing a configuration to a device, it is advisable to read first the device configuration so the device settings are loaded into the configuration program. Then make required modifications and write the configuration to the device.

Configuration is possible using either serial communication or ethernet. When ethernet is used, the configuration program is compatible with the **-EI** option of your meter, and our iServer products.



The latest Operation and Communication Manual as well as free configuration software and ActiveX controls are available from **the website listed in this manual or on the CD-ROM enclosed with your shipment.**

4. Definitions

This Guide uses some abbreviations and compact wording to signify devices and concepts with detailed descriptions. Significant items are:

4.1 METER OR DCE

The term “METER” signifies one or more meters (or devices with compatible communications) which respond to the commands (requests) of a controller device such as a computer. Such meters are classified as “DCE” devices, from the older “Data Communication Equipment” telephone specifications.

4.2 COMPUTER OR DTE

These descriptors signify the device controlling the communications, such as a computer (“HOST” device) or programmable controller. Telephony specifications refer to controllers as “Data Terminal Equipment” or DTEs.

4.3 POINT-TO-POINT

Direct connection between two (and only two) devices for data exchange, such as the meter and your digital computer. No addresses are used unless the meter is programmed for a “one-meter bus”.

4.4 MULTIPOINT (MULTI-DROP)

Shared wiring for a DTE and more than one DCE, designates a “BUS”. Several panel meters and a personal computer can share a bus, with the computer serving as controller. The controller can acquire data by transmitting the preassigned address for a meter followed by a command for the meter to send selected information. When used with the meter, up to 31 meters can share a bus (with addresses from 01 to decimal 199); all meters receive the data when the address is “00”.

4.5 SIMPLEX

A channel (path, typically a twisted pair of wires) with unidirectional data flow.

4.6 HALF DUPLEX

A channel (e.g., twisted pair) with bi-directional data flow, but only in one direction at a time.

4.7 FULL DUPLEX

Two channels (e.g., two twisted pairs) with bi-directional data flow at any time (one simplex channel in each direction).

4. Definitions

4.8 RS-232 (CCITT V.24)

Bipolar ± 5 to ± 15 V point-to-point transmission for short distances and moderate data rates. The meter operates with full-duplex RS-232, with two wires (RX and TX), plus a common ground, to transmit baud in either direction. A third signal wire, Request To Send, is referenced to the same ground wire and is used by the computer (DTE) to control transmissions of the meter (DCE).

Receiver sensitivity is ± 3 V and impedance of 3 to 7 kilohms. (Although RS-232 is nominally for only one driver and one receiver on the line, custom high-impedance versions exist for limited multipoint use.)

4.9 RTS

A designator for the "Request To Send" control signal from the computer, carried on a wire separate from that of the data, and used by the meter to permit or inhibit transmissions in Continuous Mode RS-232. The other control line of RS-232, CTS, is not used in meter communications.

4.10 RS-422

Unipolar-voltage (3.6 to 6 V supplies) simplex drive of a bus with ± 2 V-differential signals (neither wire at ground) for long distances and/or high data rates. Receiver sensitivity 200 mV, common-mode voltage range ± 3 V, and impedance 4 kilohms or more. A maximum of one driver and 10 receivers allowed, with no driver protection against bus contention. Duplex operation requires another set of hardware.

4.11 RS-485

This is the extension of RS-422 to a half or full duplex bus of up to 32 devices, with multiple drivers and driver-contention protection. Receiver impedance is now 12 kilohms or more.

4. Definitions

4.12 ASCII

Table 4.1 shows the ASCII (American Standard Code for Information Interchange) symbols which can be encoded in a 7-bit binary code (DB0 through DB6). When organized in table form, these 7 bits may be regarded as the symbol address, the most significant 3 bits determining the column and the last four bits determining the row.

These symbols include all the decimal numerals, letters, punctuation marks, common abbreviations and control characters, including non-printed symbols such as Carriage Return and Line Feed.

The 7-bit symbol code (or address) is called a “character”, and digital communication with the meter is made with a string of these characters.

When transmitted, each character is preceded by a start bit (BAUD) and followed by one or two stop bits plus an optional parity bit, making a train of 10 or 11 baud for each transmitted character. If you are building a system from the UART up (Universal Asynchronous Receiver/Transmitter), that device must be informed of the number of data bits, parity, stop bit length, etc., so that it properly decodes the incoming stream into the bytes that your program can recognize (check the UART or plug-in board literature for required control signals).

As dictated by FORMAT statements, a symbol may be sent by transmitting just its table address (one character, plain ASCII) or by HEX-ASCII, which uses two characters, one for each of the two hex address nibbles (0 through 7 for the column nibble, 0 through F for the row nibble, shown on top and left-hand side of **Table 4.1**).

4. Definitions

4.13 HEX ASCII

Storage in most digital devices is in groups of 8 bits, called bytes. Each byte has a most-significant nibble (the left most 4 bits) and a least-significant nibble.

To make the best use of the available storage, all possible bit sequences should be used, so each nibble can have 16 different values (not just the ten of decimal notation). These 16 values are symbolized by 0-9 and A-F, the hexadecimal code.

The meter transmits almost all data (shown in format statements as <data>) in this HEX-ASCII form: each byte is broken into its two nibbles, each nibble is given its HEX symbol, and the ASCII character (table address) for each of those two HEX symbols is then transmitted (most significant nibble first).

The transmitter and receiver must know whether a number or a non-numerical symbol is being sent by HEX-ASCII: this is the reason for standard FORMATS in the meter commands and responses. To illustrate this requirement, if you decode two adjacent characters as "0110100" (the code for the symbol "4") and "1000001" (the code for the symbol "A"), do you print "4A" or do you print the symbol whose hex table address is 4A, the letter "J"? The format statements tell you which is which.

The responses to "V" and "X" commands encode the numerical <data> in HEX-ASCII, but use decimal (BCD) nibbles (4 bits per decimal digit), storing these two BCD digits per byte (rather than 8 bits of straight binary). Decoding to decimal is then simplified for receiving devices such as printers.

"V" and "X" commands also use a single plain ASCII character for each "-", ".", and units-of-measure symbols, in contrast to the "G, P, R or W" commands and responses, which encode everything in HEX-ASCII, 2 characters to the byte.

4. Definitions

Table 4.1. The ASCII Character Code

						COL	0	1	2	3	4	5	6	7
						DB6=	0	0	0	0	1	1	1	1
						DB5=	0	0	1	1	0	0	1	1
						DB4=	0	1	0	1	0	1	0	1
ROW														
H E X	D E C	D B 3	D B 2	D B 1	D B 0									
0	0	0	0	0	0	NUL	DLE	SP	0	@	P	'	p	
1	1	0	0	0	1	SOH	DC1	!	1	A	Q	a	q	
2	2	0	0	1	0	STX	DC2	"	2	B	R	b	r	
3	3	0	0	1	1	ETX	DC3	#	3	C	S	c	s	
4	4	0	1	0	0	EOT	DC4	\$	4	D	T	d	t	
5	5	0	1	0	1	ENQ	NAK	%	5	E	U	e	u	
6	6	0	1	1	0	ACK	SYN	&	6	F	V	f	v	
7	7	0	1	1	1	BEL	ETB	'	7	G	W	g	w	
8	8	1	0	0	0	BS	CAN	(8	H	X	h	x	
9	9	1	0	0	1	HT	EM)	9	I	Y	i	y	
A	10	1	0	1	0	LF	SUB	*	:	J	Z	j	z	
B	11	1	0	1	1	VT	ESC	+	;	K	[k	{	
C	12	1	1	0	0	FF	FS	,	<	L	\	l		
D	13	1	1	0	1	CR	GS	-	=	M]	m	}	
E	14	1	1	1	0	SO	RS	.	>	N	^	n	~	
F	15	1	1	1	1	SI	US	/	?	O	_	o	DEL	

Non-numeric symbols (e.g., letters) or unprinted characters that are sent in hex data strings are transmitted as the two characters of their hex address;

For example: "*" is "2A"

Carriage Return is "0D"

Line feed is "0A"

XON=DC1 is "11"

XOFF=DC3 is "13".

4. Definitions

4.14 TRANSMISSION VOLTAGE LEVELS

The voltage levels accepted by the meter are those of the standards, and the meter outputs are well regulated and well within the standards. The two wires carrying the signal are designated “A” and “B”; for RS-232, “B” is taken as the 0 V ground.

Table 4.2. Meter Receiving Voltages

OPTION TYPE	“1” BIT/MARK OR STOP BIT	“0” BIT/SPACE OR START BIT
RS-232	$-3 > A > -15 \text{ V}$	$+3 < A < +15 \text{ V}$
RS-422 or 485	$A < (B-0.2 \text{ V})$	$A > (B+0.2 \text{ V})$

Table 4.3. Meter Transmitting Voltages

OPTION TYPE	“1” BIT/MARK OR STOP BIT	“0” BIT/SPACE OR START BIT
RS-232	$-6 > A > -7 \text{ V}$	$+6 < A < +7 \text{ V}$
RS-422 or 485	$A < (B-2 \text{ V})$	$A > (B+2 \text{ V})$

The RS-422/485 transmissions from the meter are 3-state, and both receive and transmit are zener-protected.

4.15 RECOGNITION CHARACTER

A selectable symbol (e.g., the asterisk, *) transmitted as the first character of each message from the computer, which is used for message security: the meter ignores messages without this symbol.

4.16 RAM

The acronym for “Random Access Memory”. For the meter, the storage for the data and instructions for the immediately-occurring operation. When given a “RESET1” or “soft” reset, the meter restarts its operation from the data in RAM. “PUT” commands insert information from the computer into RAM, and “GET” commands transmit RAM information to the computer.

4.17 EEPROM

The acronym for “Electrically Erasable Programmable Read-Only Memory”. For the meter, the non-volatile memory for the setup and configuration data is retained independent of power or resets. Upon a “RESET2” or “hard” reset (e.g., after any BLOCK WRITE command), the data in the EEPROM is copied into RAM, discarding whatever data had been running. “WRITE” commands insert information from the computer into EEPROM, and “READ” commands transmit EEPROM data to the computer.

5. Baud Rates

The meter can operate at any rate from 300 to 19,200 in 2:1 steps. Following are the baud rates used by the meter:

300, 600, 1200, 2400, 4800, 9600, and 19200.

6. Character Waveform

Ten or eleven bits are used for each character: a start bit, 7 bits for the ASCII character, one parity bit, and either one or two stop bits. If the parity bit is chosen as “none” (absent), the stop length is automatically set at two bits by the meter (to keep the minimum character length to ten bits).

Figure 6-1 shows the mark/space sequence.

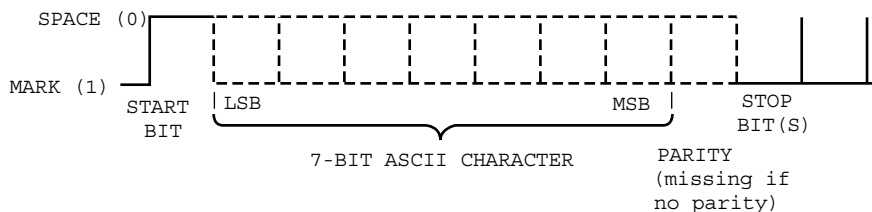

Figure 6-1. Character Waveform

The rising edge of the start bit of the next character may occur at any time after the end of the last stop bit.

7. Classes of Operation

There are two (2) classes of operation associated with meter serial communications: Point-to-point and Multipoint. (Refer to **Section 10.13**)

7.1 POINT-TO-POINT

No device address is included in the command or response message when operating in this class. There are two (2) modes associated with this class; CONTINUOUS and COMMAND.

7.1.1 CONTINUOUS MODE

For RS-232, the computer can direct the meter to repeatedly transmit the data and status information in the format specified by the communications setup (which includes a selectable parameter to space out the transmissions for data logging purposes).

Continuous mode is not used on RS-422/485, because no RTS line is present to prevent bus contention. However, you can use one meter using a RS-485 board by configuring the meter for point-to-point continuous mode, and configure it so that it is enabled at all times. This will result in allowing for transmission to be sent for longer distances to such devices as large remote displays.

Control of the continuous mode is by RTS level. Either message or character control can be specified. In the former case, RTS polarity is checked by the meter before a message is begun, but, once started, the transmission continues to the end of the specified message. In the latter case, RTS polarity is checked before each character transmission, so that the meter message can be interrupted after any character.

The specified data and status are transmitted for each new measurement (if so requested), provided that the selected baud rate and message length are adequate. If the message transmission takes longer, complete messages are sent as fast as possible, skipping any readings overlapped by a message transmission.

7. Classes of Operation

7.1.1.1 MESSAGE HANDSHAKE

The RTS line from the host controller is checked when the device is ready to send measurement data. If the RTS is true, it sends the complete message data without interruption even if RTS goes false in the middle of transmission. If RTS is false, it skips sending the data completely and continues with the next measurement.

7.1.1.2 CHARACTER HANDSHAKE

The device checks the RTS input before sending each character and sends characters only while RTS is true. It always completes sending the data before transferring the latest reading to the output buffer.

7.1.2 COMMAND MODE

In this mode, no handshake line is used, but instead a simple command from the host requests that the device transmit its latest measurement message.

7.2 MULTIPOINT

A device address from 0 to 199 is included in the COMMAND or RESPONSE message. By using the addressing capabilities, collision on the bus can be avoided. If "00" is used for the address on multiple units, they will all receive the COMMAND but will not respond. This is used to avoid collisions on the bus. There are two (2) modes available in the class; COMMAND MODE and ALARM MODE.

 **Note** NO RTS handshaking is available with Multipoint.

7.2.1 COMMAND MODE

Each device, when it receives an addressed command, checks the received address. If it matches its own pre-selected address, the device responds by fulfilling the command. After a programmed turnaround delay time, it may transmit either an acknowledgement and/or the requested data, or may have no response. If the address does not match, the command is ignored. The programmed turnaround time delay allows for line reflections to dissipate and for the transmitting host controller to switch to the receive mode. The turnaround time delay choices are 0, 30, 100 and 300 milliseconds with a 3 ms uncertainty.

7. Classes of Operation

7.2.2 ALARM MODE

All devices can be put into the alarm mode simultaneously by a single address 00 command. In the alarm mode, the bus is quiet until one of the devices detects and alarm condition. It then transmits its address onto the bus and goes out of the alarm mode. When other devices detect a character on the bus, they too go out of the alarm mode. The host program, which may have been performing an unrelated task, is then interrupted by receipt of a character and after a short delay, starts polling all devices. It begins with the received address device. All devices are polled in case two or more have reached an alarm condition at or near the same time. If this happens, it can cause bus contention, corrupted characters or framing errors. However, none of these result in system failure because any bus activity causes all devices to exit the alarm mode and the host program to perform the alarm poll. After identifying the alarm device(s), the alarm can be reset and the host controller can put the devices back into the alarm mode. It is suggested that the host controller polls all of the devices when ready to send the common alarm mode and sends it only if all alarms are inactive. This reduces the probability of two or more devices being ready to transmit on the bus simultaneously when the alarm mode is entered due to existing alarm conditions.

7. Classes of Operation

7.3 THE METER AS A REMOTE DISPLAY

The meter has the capability to become a remote display. While in this mode, it can accept any word with 1 to 6 letters (7 including one decimal point). Valid characters are: numbers from 0-9, upper-case letters from A-Z, space, period, “/”, “-”, “+”, “,” and “*”. Upon receiving the proper command from the host controller, the meter will switch to the REMOTE DISPLAY mode and display whatever has been transmitted to it.

Note  The meter will continue to operate normally during this mode.

As an example, try to write “Hello my name is Bob” to the meter number 25 decimal (19 hex) on the RS-485 network. Assume “*” is the meter’s recognition character.

Transmit according to the following steps:

- 1) *19Y01HELLO<CR>
- 2) *19Y01MY<CR>
- 3) *19Y01NAME<CR>
- 4) *19Y01IS BOB<CR>

(You would want to generate a proper delay between each step.)

To go back to “RUN” mode, use the following command: *19D03<CR>

(See **Section 8** for more information on commands).

7.4 THE METER AS A DOUBLE TASKING REMOTE METER

The Process, Strain Gauge, Temperature and Universal meters can be configured as a double tasking remote indicator/controller. This is accomplished by transmitting any value (In HEX format Only!) from “-99999 to 999999” (and any decimal point position between 1 to 6) to the meter. The value transmitted will be the meter’s Reading Value which allows you to display any value desired and assign a setpoint as well as set up the value of this setpoint. The meter can also be configured to output this value via the optional analog output boards. The double tasking is accomplished during this operation, the meter will continue to operate normally and the Filtered Value is the value used for normal operation.

Note  For comparing the transmitted value with any setpoint, the decimal point of the value should be equal to the meter’s decimal point position.

7. Classes of Operation

7.4.1 COMMAND STRUCTURE FOR DOUBLE TASKING

The general command structure for this mode is as follows:
 *[nn]Y02<DATA><CR>

Where: * = The recognition character
 nn = Device address (Required for multipoint mode only)
 Y02 = Command index
 DATA = 3 byte Hexadecimal based (24 bits) value as:

- 1) First 20 bits are the absolute value (Maximum is 999999 when positive and 99999 when negative)
- 2) Bits 21, 22, 23 are assigned to the decimal point as shown below:

BIT NO.			DECIMAL VALUE*
23	22	21	
0	0	0	Not used
0	0	1	-0
0	1	0	-1
0	1	1	-2
1	0	0	-3
1	0	1	-4
1	1	0	-5
1	1	1	Not used

* 10 to the power of the value

- 3) Bit 24 is the polarity sign
 0 = Positive
 1 = Negative

EXAMPLE: To send a value of “-23.468” to the meter, you must first send the meter number which is 15 HEX with “*” as the recognition character. The following is the itemized list of the required variables that must be sent via HEXADECIMAL:

Absolute value is 23468 and its HEX equivalent is “5BAC”

Decimal value will be “100 BINARY” and HEX equivalent is “4HEX”.

Sign is negative and must be sent as “1” and therefore bits 21, 22, 23, and 24 (or most significant nibble) will be 1100 binary or “C” HEX. Combine this with value and you have “DATA” with a Hexadecimal equivalent of “C05BAC”.

The complete command for this example is as follows:
 “*15Y02C05BAC<CR>”

8. Command and Response Structure

8.1 MESSAGE STRING

8.1.1 "DATA" AND "NON DATA"

Each of the many types of messages between computer or printer and the meter is transmitted or received as a string of ASCII characters. These characters are classified as "DATA" and "NON DATA".

"DATA" is the string of measurement or non-measurement values (see **Section 8.2** and **Section 8.3**) and can be classified as:

1. <data>: hexadecimal based values. Each nibble is converted to the ASCII character and transmitted or received.
2. <data>: is alphanumeric plain ASCII characters and need not be converted. It is used in Remote Display Mode.
3. <value> is data which is transmitted against "X" or "V01" commands. These are in decimal base, and each digit is converted to the ASCII character and transmitted along with decimal point and sign.

"NON DATA" items are: recognition character(*), device address (nn), command prefix letter (c), command suffix (cc), space (S or SP), carriage return (CR), line feed (LF), checksum (hh), and units of measure (uuu). Checksum, device address, and command suffix (cc) items are hexadecimal base, and each nibble will be converted to the ASCII character and transmitted. The rest of the "NON DATA" items are plain ASCII characters and need not be converted (see examples in **Section 8.8**).

8.1.2 BRACKETS AND SPACES

In the following text the position reserved for each ASCII character is represented by a lower-case letter. If there must always be an ASCII character put into the message at that position, no brackets are used.

Angle brackets, "<" and ">", are used to enclose names (or acronyms). In the actual message these names will be replaced by the ASCII value of that name (the number of those ASCII characters is not usually the same as the number of letters of the name inside the angle brackets).

The occurrence of non-printing ASCII characters is also indicated by angle brackets (e.g., "<CR>").

Square brackets, "[" and "]" enclose items which are optional, i.e., the message is still valid when those are omitted.

8. Command and Response Structure

8.2 COMMANDS AND STRUCTURE

The meter responds to over 150 different commands from the computer. This section gives the format and lists all commands by COMMAND CLASS and COMMAND SUFFIX.

8.2.1 READ COMMUNICATIONS CONFIGURATION COMMAND

To have the meter report its current communication parameters, the special command “^AE” is provided when transmitted to the meter with the correct baud rate, parity information, stop bit(s), and address (if multipoint). The meter will return 4 bytes (9 characters including carriage return) of information as follows:

- Byte #1 = Recognition character
- Byte #2 = Meter address
- Byte #3 = Bus Format
- Byte #4 = Communications configuration

 **Note** This “READ ONLY” command is the only one without a leading recognition character.

Command Format:

^AE<CR> for point-to-point,
or
^AE[nn]<CR> for multipoint

where nn = device address from 01 to C7 (hex) = 01 to 199 decimal.

 **Note** Response detail is given in **Sections 8.8** and **8.9**.

8. Command and Response Structure

8.2.2 GENERAL COMMAND STRUCTURE

The meter can be commanded to “read”, i.e., to transmit (send) data from either the nonvolatile memory (EEPROM) or from the volatile working memory (RAM). The meter can also be commanded to “write”, i.e., store new values for data processing or meter control.

There are different command types associated in communicating with your meter as follows:

Type (1) Commands which return non-measurement data from the meter are “**R**” and “**G**”.

Type (2) Commands which return measurement data from the meter are “**X**” and “**V**”.

Type (3) Commands which return status character data from the meter is “**U**”.

Type (4) Commands which send non-measurement data to the meter are “**P**”, “**W**”, and “**Y**”.

Type (5) Commands for disable, enable, and reset are “**D**”, “**E**”, and “**Z**”.

Table 8.1. Command Prefix Letters (Command Classes)

COMMAND PREFIX (COMMAND CLASS)	MEANING
^AE	Special read, communications parameters
P (Put)	Write HEX data into RAM
W (Write)	Write HEX data into EEPROM
G (Get)	Read HEX data from RAM
R (Read)	Read HEX data from EEPROM
U	Read status byte
V	Read measurement data string in decimal format
X	Read measurement data values in decimal format
D	Disable
E	Enable
Z	Reset
Y	Write characters or values to the meter

8. Command and Response Structure

8.2.3 COMMAND FORMATS

For “P” and “W” Command classes:

- | | |
|---|---------------------------------------|
| a) Point-to-point mode:
*ccc<data>[hh]<CR> | b) Multipoint mode:
*nnccc[hh]<CR> |
|---|---------------------------------------|
-

For “G” and “R” Command classes:

- | | |
|---|---------------------------------------|
| a) Point-to-point mode:
*ccc[hh]<CR> | b) Multipoint mode:
*nnccc[hh]<CR> |
|---|---------------------------------------|
-

For “X”, “V”, “U”, “D”, “E”, and “Z” Command classes:

- | | |
|---|---------------------------------------|
| a) Point-to-point mode:
*ccc[hh]<CR> | b) Multipoint mode:
*nnccc[hh]<CR> |
|---|---------------------------------------|
-

For “Y” Command classes:

Remote Display

- | | |
|---|---|
| a) Point-to-point mode:
*Y01<data><CR> | b) Multipoint mode:
*nnY01<data><CR> |
|---|---|

Remote Indicator Controller

- | | |
|---|---|
| a) Point-to-point mode:
*Y02<data><CR> | b) Multipoint mode:
*nnY02<data><CR> |
|---|---|

8. Command and Response Structure

Where “*” is the selected Recognition Character, you may select any ASCII table symbol from “!” (hex address “21”) to the right-hand brace (hex “7D”) except for the caret “^”, “A”, “E”, which are reserved for bus format request.

“[nn]” are the two ASCII characters for the device Bus Address. Use values from “00” to hex “C7” (199 decimal).

“ccc” stands for the HEX-ASCII COMMAND CLASS letter (one of twelve given in **Table 8.1**), followed by the two HEX-ASCII COMMAND SUFFIX characters identifying the meter data, features or menu items to which the command is directed (given in **Table 8.2**).

“<data>” is the string of characters containing the variable information the computer is sending to the meter. These data (whether BCD or binary) are encoded into HEX-ASCII characters, two characters to the byte, except for the “Y01”, “write to the display” command: here, the desired display upper-case letters, numbers or (limited) symbols are transmitted by plain ASCII characters. Square brackets (indicating optional status) enclose this <data> string, since some commands contain no data.

“[hh]” is the optional CHECKSUM BYTE, two HEX-ASCII characters equal to the modulo 256 sum of all the preceding bytes including the serial recognition character. Each addition to this sum uses the ASCII 7 bits plus the parity bit as the most-significant bit. Any carry (overflow) bits are discarded. The checksum is transmitted most-significant character first.

Message errors can be discovered by computing the checksum from the received bytes and comparing that total with the transmitted checksum. However, most systems have a good signal-to-noise ratio, so that checksum errors are rare and the procedure is infrequently used.

8. Command and Response Structure

8.2.4 - COMMAND SUFFIX

The two HEX characters following the command class letter are used to specify the data, features or menu items which the command affects. **Table 8.2** gives the command letter, suffix, feature affected, and the number of data characters included in the command.

“00” is not used (reserved for the all-device bus address).

Table 8.2. Command Letters and Suffixes

COMMAND	SUFFIX	ITEM AFFECTED	# CHAR	SECTION
D	01	Disable Alarms (SP#3 and SP#4)	0	8.2.3
E	01	Enable Alarms (SP#3 and SP#4)	0	8.2.3
R,W	01	Menu Lockout	2	10.14, 1015
U	01	Setpoints and Alarm Status	0	8.2.3
V	01	Read Data String	0	8.2.3
X	01	Read Unfiltered Value	0	8.2.3
Y	01	Write value to display	6	8.2.3
Z	01	Reset latched alarms	0	8.2.3
D	02	Disable setpoints 1 and 2	0	8.2.3
E	02	Enable setpoints 1 and 2	0	8.2.3
R,W	02	Menu Lockout and Normal Color config	2	10.14,10.15
U	02	Peak/Valley (HI/LO) status	0	8.2.3
X	02	Read Peak (HI) value	0	8.2.3
X	Y02	Write value to meter	7	8.2.3
Z	02	Reset averaging filter	0	8.2.3
D	03	Disable display of remote value	0	8.2.3
E	03	Set alarm mode	0	7.2.2
R,W	03	Setpoint (#1,#2) & Alarm Color (#1, #2)	2	10.16
X	03	Read Valley (LO) value	0	8.2.3
Z	03	Soft Reset (RESET1, from RAM)	0	8.2.3
D	04	Hold displayed value	0	8.2.3
E	04	Display “RUN”	0	8.2.3
X	04	Read filtered value	0	8.2.3
Z	04	Hard Reset (RESET2, from EEPROM)	0	8.2.3
D	05	Reset tare, valid only on strain meter	0	8.2.3
E	05	TARE, valid only on strain meter	0	8.2.3
G,P,R,W	05	INPUT, type and range (Rd.SC.OF)	2	10.10
Z	05	Reset Peak/Valley (HI/LO)	0	8.2.3
G,P,R,W	07	RdG.CNF, display controls	2	10.1
G,P,R,W	08	RdG SC, display scale factor	6	10.34
G,P,R,W	09	RdG OF, display offset	6	10.35
G,P,R,W	0A	INP.CNF, meter features	2	10.2
G,P,R,W	0B	INP SC, input scale factor	6	10.34
G,P,R,W	0C	dEC.Pt and CNt by (roundoff)	2	10.3
G,P,R,W	0E	FILT.ER and FILT.tM, filter #s	2	10.4

(continued next page)

8. Command and Response Structure

COMMAND	SUFFIX	ITEM AFFECTED	# CHAR	SECTION
G,P,R,W	10	SP.CNF, control setpoints 1 and 2	2	10.5
G,P,R,W	11	AL.CNF, control setpoints 3 and 4	2	10.6
G,P,R,W	12	AL.MOdE, alarm function	2	10.7
G,P,R,W	13	NUM.dLy, alarm delay	2	10.8
R,W	14	SP db, setpoint hysteresis	4	10.36
R,W	15	AL db, alarm hysteresis	4	10.37
G,P,R,W	16	OUT.CNF, analog out and Ad.RAtE	2	10.9
G,P,R,W	17	OUT SC, analog out scale	6	10.34
R,W	18	COMM, communications config	2	10.11
G,P,R,W	1A	AddRES, RS-485 device # address	2	10.29
G,P,R,W	1B	dAt.FMt, communication data format	2	10.12
G,P,R,W	1C	bUS.FMt, communications BUS format	2	10.13
R,W	1D	SERCNT, # of readings between transmissions	4	10.30
G,P,R,W	1E	SER.RCG, recognition character	2	10.31
G,P,R,W	1F	SER.UOM, units of measure	6	10.32
R,W	20	SER.dLy, communication turnaround delay	2	10.33
G,P,R,W	21	SP 1, setpoint 1 value	6	10.28
G,P,R,W	22	SP 2, setpoint 2 value	6	10.28
G,P,R,W	23	SP 3, setpoint 3 value	6	10.28
G,P,R,W	24	SP 4, setpoint 4 value	6	10.28
G,P,R,W	25	INP OF, input offset	6	10.35
G,P,R,W	26	OUT OF, analog output offset	6	10.35
G,P,R,W	40	RAM or EEPROM BLOCK A	60	10.17
G,P,R,W	41	RAM or EEPROM BLOCK B	38	10.18
R,W	42	EEPROM BLOCK C	20	10.19
R,W	43	EEPROM BLOCK D	-	10.20
R,W	44	EEPROM BLOCK E	-	10.21
R,W	45	EEPROM BLOCK F	-	10.22
R,W	49	Analog Output Option Board (AN03) Calibration	16	--
R,W	50	1st two bytes for "Set Color Config, 2nd two bytes for "NUM.PNt" value of Multi-point Scale & Offset	2	10.26
R,W	51	Multi-point Scale & Offset Input / Read 0 values	6	10.27
R,W	52	Multi-point Scale & Offset Input / Read 1 values	6	10.27
R,W	53	Multi-point Scale & Offset Input / Read 2 values	6	10.27
R,W	54	Multi-point Scale & Offset Input / Read 3 values	6	10.27
R,W	55	Multi-point Scale & Offset Input / Read 4 values	6	10.27
R,W	56	Multi-point Scale & Offset Input / Read 5 values	6	10.27
R,W	57	Multi-point Scale & Offset Input / Read 6 values	6	10.27
R,W	58	Multi-point Scale & Offset Input / Read 7 values	6	10.27
R,W	59	Multi-point Scale & Offset Input / Read 8 values	6	10.27
R,W	5A	Multi-point Scale & Offset Input / Read 9 values	6	10.27

8. Command and Response Structure

NOTES:

1. Each BLOCK is the string of HEX-ASCII data which is produced by the concatenation of the data for single items listed below:

BLOCK A =
26+17+25+0B+09+08+24+23+22+21

BLOCK B =
1E+1F+20+1A+18+13+12+11+10+05+0C+16+07+1C+1B+0E+0A

BLOCK C =
1D+15+14+04+03+02+01



BLOCKS D, E AND F are meter factory calibration values. Adjustment of these values should be made with care, preferably using a well-equipped calibration laboratory.

2. Suffixes 06, 0D, 0F, and 19 are not used: the meter will respond to these with an error message.
3. The meter, upon completion of a BLOCK PUT (into RAM) Command, goes to soft reset, "**RESEt1**", which does not copy EEPROM data into RAM.
4. Upon completion of a BLOCK WRITE (into EEPROM) Command, however, the meter goes to hard reset, "**RESEt2**", copying the data from EEPROM into the working RAM. Single PUT (or WRITE) commands do not interrupt the measurement process of the meter, even when the changes are to scale or offset values.
5. <data> encoding for Write and Put Commands will be described in **Section 10** with each Read and Get response.

8. Command and Response Structure

8.3 RESPONSE STRUCTURE

The meter transmits different response formats according to the type of command it receives, e.g. if it is in echo or no-echo mode and if an error has occurred or not.

8.3.1 NO ERROR

8.3.2 ECHO MODE (SEE SECTIONS 10.13)

For type (1) Command:

[nn]ccc<data>[hh]<CR>[<LF>]

For type (2) Command:

a) Response for "V01" Command

[nn][V01][Sa[b]]S<value>[S<value>][S<value>][S<value>][<SP>uuu][hh]<CR>[<LF>]

b) Response for "X" Command

[nn][ccc]<value>[hh]<CR>[<LF>]

For type (3) Command:

[nn][ccc]<d>[hh]<CR>[<LF>]

For type (4) Command:

a) For "P" and "W" Command:

[nn][ccc][hh]<CR>[<LF>]

b) For "Y" Command

[nn]Y01<CR>[<LF>]

For type (5) Command:

[nn]ccc[hh]<CR> [<LF>]

8.3.3 NO ECHO MODE

For Commands "P", "W", "D", "E", "Z", and "Y" No response will be transmitted

For Type (1) Commands:

<data>[hh]<CR>[<LF>]

For Type (2) Commands:

a) For "V01" Command:

[Sa[b]]S<value>[S<value>][S<value>][S<value>][<SP>uuu][hh]<CR>[<LF>]

b) For "X" Command:

<value>[hh]<CR>[<LF>]

For Type (3) Commands:

<d>[hh]<CR>[<LF>]

8. Command and Response Structure

8.3.3 NO ECHO MODE continued

Where “nn” is the meter’s address in HEX format and is omitted from the response format if the communication is in the point-to-point mode. “ccc” is the three (3) character command prefix letter and it’s suffix number. “d” is one ASCII character.

“[hh]” is the optional checksum “CR” is carriage return “[<LF>]” is optional line feed.

“[Sa[b]]” is the optional alarm status character followed by the optional peak/valley status character. Alarm status character is preceded by the chosen plain-ASCII separator character, <S> or <CR>, depending on how you want this data displayed.

“S<value>” is the separator followed by the decimal-digit measurement value, with plain-ASCII minus sign (if any) and decimal point.

“[S<value>]” is the optional inclusion of the separator followed by any one of the three added decimal-digit values listed above.

“[<SP>uuu]” is the optional three units-of-measure characters (letters or other printable plain-ASCII symbols) preceded by a space; “<CR>” is the terminating plain-ASCII Carriage Return character.

[<LF>] optional line feed.



A positive overflow in any one of the <value>s results in the transmission of “?+999999” for that value; negative overflow sends “?-999999”.

8.4 DATA LENGTH CORRESPONDING TO THE RESPONSE STRUCTURE

For “R” and “G” Commands:

Data is equivalent to the “W” and “P” Commands respectively (see **Table 8-2**).

For “V01” and “X” Commands:

- a) Value has 7 characters (like 724.352 or -233.45), unless overflow occurs in which case it consists of 8 characters (see previous note)
- b) Status characters “a” or “b” are each one character

For “U” Commands: Data is one character.

8. Command and Response Structure

8.5 ERROR RESPONSE

The meter is capable of detecting the different errors during the communication process and will transmit an indicating message to the host controller.

8.5.1 ERROR RESPONSE FORMAT

1. Echo Mode
[nn]?ee<CR>[<LF>]
2. No echo mode
?ee<CR>[<LF>]

where “?ee” is the special code indicating an error has occurred as follows:

8.5.2 ERROR MESSAGE

Table 8.3 Error Messages

	ERROR MESSAGE	CODE
1	Command Error	?43
2	Format Error	?46
3	Checksum Error	?48
4	Parity Error	?50
5	Calibration/Write Lockout Error	?4C
6	EEPROM Write Lockout Error	?45
7	Serial Device Address Error	?56
8	Decimal Point Error	?56
9	Serial Recognition Error	?56
10	Invalid Character(s) used in <data> with Y01 Command	?56

8. Command and Response Structure

8.5.3 DESCRIPTION

1. COMMAND ERROR occurs when:
 - a. Command prefix letter is not valid
 - b. Command suffix is not valid
2. FORMAT ERROR occurs when:
 - a. Length of the message is either shorter or longer than it should be.
 - b. Any other character than "0-F" used for hexadecimal values
3. CALIBRATION LOCKOUT ERROR occurs if jumper "S3B" on the Main Board has been removed to prohibit any changes in calibration.
4. EEPROM WRITE LOCKOUT ERROR occurs if any write ("W") Command has been issued to the meter and the jumper position "S3-A" on the Main Board of the meter has been removed
or
External pin 10 on the rear connector "P2" of the meter has been grounded.
5. SERIAL RECOGNITION CHARACTER ERROR occurs if a new value is between 0 to 1F (hex) or larger than 7F (hex). "^", "A", "E", are not valid since those are used in the special communication command "^AE".
6. SERIAL DEVICE ADDRESS ERROR occurs if the new value is larger than 199 decimal.
7. DECIMAL POINT ERRORS occur if:
 - a) New value is 0 or larger than 6 (3 when the meter is in the Thermocouple or RTD modes).
 - b) New value causes the reading offset to overflow, i.e. if larger that 999999 or smaller that -99999.
 - c) New value causes any of the setpoints to overflow, i.e. if larger that 99999 or smaller that -99999.

IMPORTANT NOTES:

- 1) The meter will not respond to a command if the command's recognition character does not match the meter's recognition character.
- 2) When in multipoint mode, the meter will test the command's address with the one previously assigned after the recognition character has been matched. The meter will not respond to the command if addresses do not match, even if an error has occurred.
- 3) If the meter is in the Menu or Setpoint mode and receives any transmitted data, it quits that routine, displays "**SERIAL**" for up to two seconds, completes its Communication job, and then resets the meter, i.e., hard reset (RESET 2) from Menu, or soft reset (RESET 1) from Setpoint.
- 4) Any attempt to use push buttons when meter is in Transmit/Receive mode will be denied and followed by the display of "**SERIAL**", indicating that Communication is in process.

8. Command and Response Structure

8.6 STATUS CHARACTER FORMATS

The meter upon receiving U01 or U02 Command will transmit alarm or peak/valley status characters respectively.

8.6.1 ALARM STATUS CHARACTERS

Table 8.4 shows the transmitted character for each of the sixteen possible setpoint/alarm states. (Note the binary progression.)

Table 8.4. Alarm Status Characters

CHARACTER	SP#4	SP#3	SP#2	SP#1
@	OFF	OFF	OFF	OFF
A	OFF	OFF	OFF	ON
B	OFF	OFF	ON	OFF
C	OFF	OFF	ON	ON
D	OFF	ON	OFF	OFF
E	OFF	ON	OFF	ON
F	OFF	ON	ON	OFF
G	OFF	ON	ON	ON
H	ON	OFF	OFF	OFF
I	ON	OFF	OFF	ON
J	ON	OFF	ON	OFF
K	ON	OFF	ON	ON
L	ON	ON	OFF	OFF
M	ON	ON	OFF	ON
N	ON	ON	ON	OFF
O	ON	ON	ON	ON

8. Command and Response Structure

8.6.2 PEAK/VALLEY (HI/LO) STATUS CHARACTERS

Table 8.5 gives the characters transmitted to show changes in Peak/Valley readings.

The meter keeps track of Peak and Valley changes at the completion of each measurement, so that the occurrence of new values can be signaled. However, transmissions of PEAK/VALLEY status may be commanded less often: therefore, the meter also monitors if Peak or Valley values have changed since the last status transmission.

TABLE 8.5 PEAK/VALLEY STATUS CHARACTERS

CHARACTER	PEAK LARGER THAN LATEST TRANSMISSION	VALLEY LESS THAN LATEST TRANSMISSION	PEAK LARGER THAN LATEST READING	VALLEY LESS THAN LATEST READING
@	NO	NO	NO	NO
D	NO	YES	NO	NO
E	NO	YES	NO	YES
H	YES	NO	NO	NO
J	YES	NO	YES	NO
L	YES	YES	NO	NO
M	YES	YES	NO	YES
N	YES	YES	YES	NO

8. Command and Response Structure

8.7 "V01" RESPONSE DATA FORMAT

As described in **Section 8.3** response to the "V01" Command has the following format if in echo mode:

[nn][V01][Sa[b]]S<value>[S<value>][S<value>][S<value>][<SP>uuu][hh]<CR>[<LF>]

"nnV01" is omitted from the response format if in no-echo mode; where:

TABLE 8.6 SPECIAL CHARACTERS

CHARACTERS	
a	Alarm status character
b	Peak/valley status character
first<value>	Value of current reading
second<value>	Value of filtered reading
third<value>	Value of peak reading
fourth<value>	Value of valley reading
<SP>	Space
S	Space or <CR>
<uuu> ¹	Three characters for the unit of measurement
<uuu> ²	N/A
hh	Checksum
<CR>	Carriage return
LF	Line feed
[]	Optional item

The length of the message transmitted by the meter in response to the "V01" command is variable and controlled by the two menu items as "**dAt Fmt**" (Data Format) and "**bUS.FMt**" (Bus Format). (See **Sections 10.12** and **10.13**).

8. Command and Response Structure

8.8 “^AE” RESPONSE FORMAT

The meter’s response to “^AE[nn]<CR>” is 4 bytes of data, sent as 8 HEX-ASCII characters, followed by a carriage return (no other characters even when programmed to echo). These four bytes are:

- 1: Serial Recognition Character below; e.g., “*”, sent HEX-ASCII “2A”)
- 2: Device ID (INF-B)
- 3: Bus Format Byte (“*bUS.FMt*”; e.g., HEX-ASCII “5C” for multipoint mode with echo)
- 4: Serial Communications Configuration Byte (“*COMM*”: e.g., HEX-ASCII “56” for 2 stop bits, even parity, and 19200 baud)

8.9 EXAMPLES:

The following are examples of the different commands and their proper responses from meters. For the following examples assume that:

- a) echo mode
- b) “*” as the recognition character of the meter
- c) meter’s address is “15 HEX” if it is used in the multipoint mode
- d) no line feed or checksum characters are included

1. Read serial recognition character from EEPROM in point-to-point mode:

Command format *R1E<CR>
Response format R1E2A<CR>
(Since “2A” is HEX-ASCII value of “*” in the table).

2. Read serial address from the RAM of the meter number “15 HEX” in the multipoint mode:

Command format *15G1A<CR>
Response format 15G1A15<CR>

3. Write “VLT” as units of measure into the EEPROM of the meter in the point-to-point mode:

Command format *W1F564C54<CR>
Response format W1F<CR>

where 56, 4C, 54 are the three HEX ASCII values for V, L, and T respectively.

8. Command and Response Structure

4. Read alarm status character from the meter number 15 HEX:

Command format *15U01<CR>
Response format 15U01@<CR>

where “@” is the alarm status character, decoded using **Table 8.4**.

5. Enable setpoints number 3 and 4 in point-to-point mode:

Command format *E01<CR>
Response format E01<CR>

6. Hold display value on meter number 15 HEX:

Command format *15D04<CR>
Response format 15D04<CR>

7. Cold reset (reset 1) in point-to-point mode:

Command format *Z04<CR>
Response format Z04<CR>

8. Publish measurement string from the meter in point-to-point mode:

Command format *V01<CR>
Response format V01 567.891 567.880 712.345 110.765<CR>

9. Publish current reading value from the meter number 15 HEX in multipoint mode:

Command format *15X01<CR>
Response format X01 567.891<CR>

10. Read block of data from EEPROM in point-to-point mode:

Command format *R42<CR>
Response format R42271100010001EO3E003F<CR>

11. Display “HELLO” onto the meter number 15 HEX in multipoint mode:

Command format *15Y01HELLO<CR>
Response format 15Y01<CR>

9. Meter Bus Response

As detailed before, the meter can receive and transmit at baud rates up to 19,200. No data is ever lost by the meter even at the highest rate with the most complex meter program, provided that the computer does not attempt to interrupt a transmission from the meter by transmitting at the same time.

When not transmitting, the meter continually looks for a new character on the bus. When any character is received, the meter drops out of ALARM mode; (if in that mode) checks for the Recognition Character, the start of a new message.

9.1 POINT-TO-POINT OR MULTIPOINT COMMAND MODE

If the recognition character is correct, the meter now checks for the address in the Multipoint mode.

When a match is obtained, the meter then decodes the Command Code and fulfills that command. Otherwise, the meter ignores the command and continues to look for another recognition character.

9. Meter Bus Response

9.1.1 METER'S RESPONSE TIME

RESPONSE TIME: this is the period from the time the meter detects the first command character to the time that it starts transmitting proper response.

Response time = Transmit command time + program delay time + turn around delay time.

Where:

Transmit Command Time = the transmission period of full command from the host computer to the meter.

$[(\# \text{ of bits in a character}) * (\# \text{ of characters})] - [\text{baud rate}]$ (in seconds)

where: * = Multiply

of bits in a character = 10 or 11 (see **Sections 4.12** and **6**)

Turn around delay = Receive to transmit delay and can be programmable to 0, 30, 100, 300 ms. For the following data turn around delay assumed **0**.

TABLE 9.1 READING RATE FOR COMMAND MODE

Sample Rate	Process (100mV) Rate (ms) (Turn Around - Time ms)	TC(K type) Rate (ms) (Turn Around - Time ms)
0 (slow)	7(135 ms)	7(135 ms)
1	14(68 ms)	14(68 ms)
2	27(36 ms)	28(36 ms)
3	52(19 ms)	28(30 ms)
4	60(14 ms)	28(30 ms)
5 (fast)	60(14 ms)	28(30 ms)

Test with Command Mode (Baud Rate at 19200 bps, Command Mode)

For the Command Mode, if the command-sending turn-around time is shorter than the turn-around time in the above table (Refer to Process or TC), the response will have some duplicate readings. For example, if the sample rate is 1 in process, the command sending turn-around time should be larger than 68 ms.

 Although single long transmission's delay seems longer than chunk transmission, in most cases total transmission time will be shorter, especially using 19200 baud rate.

9. Meter Bus Response

9.2 POINT-TO-POINT CONTINUOUS MODE

As described before, the meter transmits its different measurement values in strings of characters continuously on the bus. The length of the string is variable and is controlled by two menu items: **“Dat.Fmt”** and **“bUS.Fmt”** (see **Sections 10.12** and **10.13**). The time between consecutive transmission is also controlled by another menu item: **“SERCnt”**. This item is in units of “numbers of readings” (**Section 10.20**).

9.2.1 METER’S RESPONSE TIME

This is the difference in time from the moment when the Serial Count (**“SERCnt”**) value is reached to the time of transmission of the first character of the data string.

TABLE 9.2 READING RATE FOR COMMUNICATION

Sample Rate	Process (100mV) Rate (ms)	TC (K type) Rate (ms)
0 (slow)	7(135)	7(135)
1	14(68)	14(68)
2	27(36)	27(36)
3	52(19)	33(30)
4	71(14)	33(30)
5 (fast)	71(14)	33(30)

Test with Communication (Baud Rate at 19200 bps, Continuous Mode)



Although transmission’s program delay seems longer than chunk transmission, in most cases total transmission time will be shorter, especially using 19200 baud rate.

9.2.2 COMMUNICATING WITH THE METER WHEN IN CONTINUOUS MODE

If the meter is in point-to-point continuous mode, it ignores any transmitting command. On the other hand, transmitting “X-OFF” character (13 Hex) which is equivalent to the “RTS line false” will halt continuous transmission. Transmitting “X-ON” character (11 hex) or making “RTS line true” will resume continuous transmission. Specifically, if command “^AE” is transmitted, it will cause the meter to switch to COMMAND mode.

To be able to communicate with the meter when in Continuous Mode, do the following:

1. Transmit “X-OFF” character or make “RTS” line false.
2. Transmit “^AE” command. Now your meter is in Command Mode.
3. Do the communication with the meter.
4. Use “P1C” command to change BUS FORMAT (see **Section 10.13**) i.e., change bit #4 of **“bUS Fmt”** from 1 to 0 to go back to Continuous Mode

9. Meter Bus Response

9.3 MULTIPOINT ALARM MODE RESPONSE

The meter is commanded into the ALARM mode by detecting the alarm code—E03 after its own address or the common 00 address. It stays silent unless an alarm already exists. If an alarm is detected, it immediately transmits its own address with its alarm status characters. No turnaround time delay is used. All devices on the bus which are in the ALARM mode drop out of that mode if any character is detected on the bus, so that bus contention is minimized.

The program for the controlling device (computer) is usually written to poll the alarm status of all devices once bus activity is detected after an alarm command, so that nearly-simultaneous alarm conditions are properly detected. Such a meter poll by the computer after an alarm response usually starts at the detected device address, or at device 01 in case of a garbled address (if two or more devices alarm at once).

If there is adequate time allowance in the data acquisition program, the computer may poll the alarm status of all meters before commanding the ALARM mode to reduce the probability of bus contention and garbled transmissions.

- a) Slow mode = 0 to 300 ms
- b) fast mode = 0 to 100 ms

 Although transmission's program delay seems longer than chunk transmission, in most cases total transmission time will be shorter, specially using 19200 baud rate.

9.4 WATCHDOG TIMER FOR COMMUNICATION

There is an eight second watchdog timer available in the communication portion of the meter. When the computer starts sending a command to the meter, meter enables its receive mode and starts getting the incoming characters, until a carriage return completes the command string. Then the meter disables its receive mode and enables its transmission mode to transmit or act according to the command information. Receive mode time is the period that the meter is in receive mode. Receive time should always be less than eight seconds, otherwise meter will ignore the command and will finish the receive mode (there will be no affect on the performance of the meter). In this case command should be executed again.

 Watchdog timer is disabled when meter is in continuous communication mode.

10. Data Format Commands (P, G, R, W)

This section introduces data formats in detail. The following conditions are assumed in the text and in examples in this section

1. The recognition character is the asterisk(*).
2. The meter address number is 15 HEX (21 decimal)
3. When “W” command is given, a reset is necessary to initiate the command.
4. “X” in bit pattern information means the bit is not related to that parameter.
5. Each byte consists of 8 bits.
6. Each byte consists of 2 nibbles; Most Significant Nibble (MSN) and Least Significant Nibble (LSN)

10. Data Format Commands (P, G, R, W)

10.1 READING CONFIGURATION (“RdG.CNF”)

TABLE 10.1 READING CONFIGURATION

BIT POSITION								RdG.CNF
7	6	5	4	3	2	1	0	
							0	<i>dIRECT</i> Direct Format for Rd.SC.OF
							1	<i>2.CdINT</i> 2-Coordinate Format for Rd.SC.OF
						0		<i>dP.ACTV yES</i> Active Decimal Point
						1		<i>dP.ACTV NO</i> Independent Decimal Point
					0			<i>SP1.FLS dISABL</i> SP1 Flashing
					1			<i>SP1.FLS ENAbLE</i> SP1 Flashing
				0				<i>SP2.FLS dISABL</i> SP2 Flashing
				1				<i>SP2.FLS ENAbLE</i> SP2 Flashing
			0					<i>AL1.FLS dISABL</i> AL1 Flashing
			1					<i>AL1.FLS ENAbLE</i> AL1 Flashing
		0						<i>AL2.FLS dISABL</i> AL2 Flashing
		1						<i>AL2.FLS ENAbLE</i> AL2 Flashing
0	0							<i>H.bRt</i> HIGH BRIGHTNESS
0	1							<i>M.bRt</i> MEDIUM BRIGHTNESS
1	0							<i>L.bRt</i> LOW BRIGHTNESS
1	1							(Not Used)

EXAMPLE: To set Rd.SC.OF direct format, Decimal Point active, Display flashing as input value reaches SP1 or Alarm1 (SP3) and Display LED's at high brightness level:

The command data is 00010100 BIN. = 14 HEX. Then send ***W0714**

10. Data Format Commands (P, G, R, W)

10.2 INPUT CONFIGURATION (“INP.CNF” and “INPUT”)

TABLE 10.2 INPUT CONFIGURATION

BIT POSITION								INP.CNF and INPUT
7	6	5	4	3	2	1	0	
							0	60 Line Frequency 60Hz
							1	50 Line Frequency 50Hz
							0	SLOW (14/SEC) Reading Rate
							1	FAST (100/SEC) Reading Rate
					0			UNIPOL Voltage Unipolar; tC
					1			BIPOL Voltage Bipolar
			0	0				C Unit of Temperature Degree C
			0	1				F Unit of Temperature Degree F
			1	0				k Unit of Temperature Degree K
			1	1				(Not Used)
		0						tC.CO.JC ENABLE TC Cold Junction;
		1						3.LINR 3 wire linear RTD;
								NORMAL Bridge Limit; Process (Not Used)
								tC.CO.JC DISABL TC Cold Junction;
								4.LINR 4 wire linear RTD ;
								SP1.L2.H SP1 lower overload limit and SP2 upper overload limit; Process - (Not Used)
	0							IN.SC.OF DISABL Input Scale & Offset
	1							IN.SC.OF ENABLE Input Scale & Offset
0								RAtIO DISABL Strain Non-Ratiometric;
								TC & Process Default
1								RAtIO ENAbLE Strain Ratiometric

EXAMPLE: To set the meter with line frequency of 50 Hz, slow reading rate (in case of MENU 2), degree K unit of measure, TC Cold-Junction enabled (in case of TC mode) and input scale and offset enabled:

The command data is 01010001BIN. = 51 HEX. Then send ***W0A51**

10. Data Format Commands (P, G, R, W)

10.3 SETTING COUNT BY (“CNtby”) AND DECIMAL POINT (“SEt dP”)

TABLE 10.3 COUNT BY and DECIMAL POINT

BIT POSITION								CNTby and SEt dP
7	6	5	4	3	2	1	0	
					0	0	0	001 Count By 1
					0	0	1	002 Count By 2
					0	1	0	005 Count By 5
					0	1	1	020 Count By 10
					1	0	0	020 Count By 20
					1	0	1	050 Count By 50
					1	1	0	100 Count By 100
					1	1	1	(Not Used)
				X				(Not Used)
	0	0	0					NONE
	0	0	1					FFFFFF
	0	1	0					FFFFFF.F
	0	1	1					FFFF.FF
	1	0	0					FFF.FFF
	1	0	1					FF.FFFF
	1	1	0					F.FFFFF
	1	1	1					(Not Used)
X								(Not Used)

EXAMPLE: To set the meter’s display decimal point at the 4th position (**FFF.FFF**) and reading value counted by 2:

The command data is 01000001BIN. = 41 HEX. Then send ***W0C41**

10. Data Format Commands (P, G, R, W)

10.4 FILTER CONFIGURATION “FILtER” AND “Out.tyP”

TABLE 10.4 FILTER CONFIGURATION and OUTPUT TYPE

BIT POSITION								FILtER and Out.tyP
7	6	5	4	3	2	1	0	
					0	0	0	001 Filter Time 1
					0	0	1	002 Filter Time 2
					0	1	0	004 Filter Time 4
					0	1	1	008 Filter Time 8
					1	0	0	016 Filter Time 16
					1	0	1	032 Filter Time 32
					1	1	0	064 Filter Time 64
					1	1	1	128 Filter Time 128
				X				(Not Used)
			0					A.b.C.FIL ABC Filter Type
			1					MOV.AVE Moving Average Filter Type
		1						FILtRd Filtered Value on the Display
0	0							UNFILt Unfiltered Value to Analog Output
0	1							FILtRd Filtered Value to Analog Output
1	0							PEAk Value to Analog Output
1	1							VALLy Value to Analog Output

EXAMPLE: To set the meter’s display with a rapid changing input signal the filter time constant should be higher (for example FILt.tM = 32), switch Filter Type to MOV.AVE, and set Output Type to be filtered:

The command data is 01110101BIN. = 75 HEX. Then send ***W0E75**

10. Data Format Commands (P, G, R, W)

10.5 SETPOINT 1 AND 2 CONFIGURATION (“SP.CNF”)

Table 10.5 Setpoint Configuration

BIT POSITION								SP.CNF	
7	6	5	4	3	2	1	0		
							0	AbOVE	SP1 Active Above
							1	bELOW	SP1 Active Below
						0		N.OPEN	SP1 Normal Open
						1		N.CLOSE	SP1 Normal Close
					0				SP1 Use Un-filtered Value
					1				SP1 Use Filtered Value
				0				AbOVE	SP2 Active Above
				1				bELOW	SP2 Active Below
			0					N.OPEN	SP2 Normal Open
			1					N.CLOSE	SP2 Normal Close
		0							SP2 Use Un-filtered Value
		1							SP2 Use Filtered Value
	0								SP1 & SP2 Enable
	1								SP1 & SP2 Disable
0									LED1 & 2 Enable
1									LED1 & 2 Disable

EXAMPLE: Set Setpoint 1 (SP1) active above, Relay 1 at normal close, Setpoint 2 (SP2) active below, Relay 2 at normal open, enable SP1 and SP2’s function, and LED’s light up when input signal filtered value reaches the Setpoint 1 and 2:

The command data is 00101110BIN. = 2E HEX. Then send ***W102E**

10. Data Format Commands (P, G, R, W)

10.6 ALARM (SETPOINTS 3 AND 4) CONFIGURATION (“AL.CNF”)

TABLE 10.6 ALARM CONFIGURATION

BIT POSITION								AL.CNF
7	6	5	4	3	2	1	0	
							0	AbOVE AL1 Active Above
							1	bELOW AL1 Active Below
						0		N.OPEN AL1 Normal Open
						1		N.CLOSE AL1 Normal Close
					0			AL1 Use Un-Filtered Value
					1			AL1 Use Filtered Value
				0				AbOVE AL2 ACTIVE Above
				1				bELOW AL2 ACTIVE Below
			0					N.OPEN AL2 Normal Open
			1					N.CLOSE AL2 Normal Close
		0						AL2 Use Un-Filtered Value
		1						AL2 Use Filtered Value
	0							AL1 & AL2 Enable
	1							AL1 & AL2 Disable
0								ALARM RESET Enable AT P2-11
1								ALARM RESET Disable AT P2-11

EXAMPLE: To enable Alarm 1 & 2 and setup Alarm1 to activate above Alarm 1 value, Relay at normal open and use of filtered input value. However, set Alarm 2 to activate below Alarm 2 value, Relay at normal close, use of unfiltered input value and Alarm reset disabled at pin#11 of rear terminal P2:

The command data is 10011100 BIN. = 9C HEX. Then send ***W119C**

10. Data Format Commands (P, G, R, W)

10.7 ALARM FUNCTIONS (“AL.CNF and AL.MOdE”)

TABLE 10.7 ALARM CONFIGURATION AND MODE

BIT POSITION								AL.CNF and AL.MOdE	
7	6	5	4	3	2	1	0		
						0	0	PROC AL1 Process	
						0	1	HI dEV AL1 HIGH Deviation	
						1	0	LO dEV AL1 LOW Deviation	
						1	1	bNd.dEV AL1 BAND Deviation	
					0			UNLtCH AL1 Un-Latched Alarm	
					1			LAtCH AL1 Latched Alarm	
				X				(Not Used)	
		0	0					PROC AL2 Process	
		0	1					HI dEV AL2 HIGH Deviation	
		1	0					LO dEV AL2 LOW Deviation	
		1	1					bNd.dEV AL2 BAND Deviation	
	0							UNLtCH AL2 Un-Latched Alarm	
	1							LAtCH AL2 Latched Alarm	
X								(Not Used)	

EXAMPLE: Set Alarm 1 function mode as Band Deviation, latched and Alarm 2 function mode as Process, latched.

The command data is 01000111 BIN. = 47 HEX. Then send *W1247

10.8 ALARM DELAY: (“NUM.dLy”)

TABLE 10.8 ALARM DELAY

BIT POSITION								NUM.dLy (ALARM DELAY)	
7	6	5	4	3	2	1	0		
				X	X	X	X	0-15 for AL2	
X	X	X	X					0-15 for AL1	

EXAMPLE: These 2 bytes enable users to select the number of input readings required to trigger Alarm 1 (SP3), and Alarm 2 (SP4) action that will delay the alarm activation. Choose 7 for Alarm 2 and 9 for Alarm 1 as the number of input readings before meter activates the alarm:

The command data is 10010111 BIN. = 97 HEX. Then send *W1397

10. Data Format Commands (P, G, R, W)

10.9 OUTPUT CONFIGURATION (“*Out.CNF*”) and A to D RATE (“*Ad.RAtE*”)

TABLE 10.9 OUTPUT CONFIGURATION

BIT POSITION								Out.CNF and Ad.RAtE
7	6	5	4	3	2	1	0	
							0	<i>dISABLE</i> Analog Output
							1	<i>ENABLE</i> Analog Output
						0		0-10 V Output
						1		0-20 mA Output
					0			Parallel BCD dISABL (not used)
					1			Parallel BCD ENABLE (not used)
				0				BCD Output Display Value (not used)
				1				BCD Output Peak Value (not used)
			0					Standard Print (Desktop) (not used)
			1					Special Printer (Panel Printer) (not used)
0	0	0						0 A to D Convert Rate 0
0	0	1						1 A to D Convert Rate 1
0	1	0						2 A to D Convert Rate 2
0	1	1						3 A to D Convert Rate 3
1	0	0						4 A to D Convert Rate 4
1	0	1						5 A to D Convert Rate 5
1	1	0						(Not Used)
1	1	1						(Not Used)

EXAMPLE: Enable Analog Output, which produces a 0-20 mA current source and set the A to D conversion rate to 2:

The command data is 01000011 BIN. = 43 HEX. Then send ***W1643**

10. Data Format Commands (P, G, R, W)

10.10 INPUT TYPE (“*INPUt*”) and READING SCALE & OFFSET (“*Rd.SC.OF*”)

TABLE 10.10 INPUT TYPE and READING SCALE & OFFSET

BIT POSITION								INPUT and Rd.SC.OF
7	6	5	4	3	2	1	0	
				0	0	0	0	TC: J ; RTD: 2Pt392 2 wire 100ohm a=392; Process: +/-50mV, 0-100mV ; Current: 0-20mA
				0	0	0	1	TC: K ; RTD: 3Pt392 3 wire 100ohm a=392; Process: +/-500mV, 0-1V ; Current: 4-20mA
				0	0	1	0	TC: T ; RTD: 4Pt392 4 wire 100ohm a=392; Process: +/-5V, 0-10V
				0	0	1	1	TC: E ; RTD: 2Pt385 2 wire 100ohm a=385; Process: +/-50V, 0-100V
				0	1	0	0	TC: N ; RTD: 3Pt385 3 wire 100ohm a=385
				0	1	0	1	TC: DINJ ; RTD: 4Pt385 4 wire 100ohm a=385
				0	1	1	0	TC: R ; RTD: 3.LINR 3 wire Linear or Ohms
				0	1	1	1	TC: S ; RTD: 4.LINR 4 wire Linear
				1	0	0	0	TC: B
	0	0	0					TC
	0	0	1					Rtd
	0	1	0					VOLt
	0	1	1					CURRNt
	1	0	0					(Not Used)
	1	0	1					bRIdGE
	1	1	0					POt
	1	1	1					(Not Used)
0								Rd.SC.OF dISAbL
1								Rd.SC.OF ENAbLE

EXAMPLE: To select 0-100 Volt range input type and enable Reading Scale and Offset :

The command data is 10100011 BIN. = A3 HEX. Then send ***W05A3**

10. Data Format Commands (P, G, R, W)

10.11 SERIAL COMMUNICATIONS CONFIGURATION (“COMM”)

TABLE 10.11 SERIAL COMMUNICATIONS CONFIGURATION

BIT POSITION								COM.PAR and MOdbUS
7	6	5	4	3	2	1	0	
					0	0	0	Baud Rate 300
					0	0	1	Baud Rate 600
					0	1	0	Baud Rate 1200
					0	1	1	Baud Rate 2400
					1	0	0	Baud Rate 4800
					1	0	1	Baud Rate 9600
					1	1	0	Baud Rate 19200
					1	1	1	(Not Used)
				0				MODBUS Disable
				1				MODBUS Enable
		0	0					NONE PARITY
		0	1					ODD PARITY
		1	0					EVEN PARITY
		1	1					(Not Used)
	0							ONE STOP BIT
	1							TWO STOP BIT
X								(Not Used)

EXAMPLE: To set the baud rate to 19200, enable Modbus, None Parity and one stop bit:

The command data is 00001110 BIN. = 0E HEX. Then send ***W180E**

10. Data Format Commands (P, G, R, W)

10.12 DATA FORMAT ("*dat.FMt*")

TABLE 10.12 DATA FORMAT

BIT POSITION								DA <i>t.FMt</i>
7	6	5	4	3	2	1	0	
							0	Alarm Status - EXCLUDED
							1	Alarm Status - INCLUDED
						0		Peak / Valley Status - EXCLUDED
						1		Peak / Valley Status - INCLUDED
					0			Current Reading - EXCLUDED
					1			Current Reading - INCLUDED
				0				Filtered Value - EXCLUDED
				1				Filtered Value - INCLUDED
			0					Peak Value - EXCLUDED
			1					Peak Value - INCLUDED
		0						Valley Value - EXCLUDED
		1						Valley Value - INCLUDED
	0							Use Space as Separator
	1							Use <CR. as Separator
0								Units of Measurement - EXCLUDED
1								Units of Measurement - INCLUDED

EXAMPLE: To format the data string, which includes Alarm status, Peak/Valley, Current, Filtered input value status, units of measure and listed by underline instead of space separated:

The command data is 11001111 BIN. = CF HEX. Then send ***W1BCF**

10. Data Format Commands (P, G, R, W)

10.13 COMMUNICATIONS BUS FORMAT (“*bUS.FMt*”)

TABLE 10.13 BUS FORMAT

BIT POSITION								bUS.FMt
7	6	5	4	3	2	1	0	
							0	Checksum - EXCLUDED
							1	Checksum - INCLUDED
						0		NO Line Feed
						1		Line Feed following with <CR.
					0			NO ECHO
					1			ECHO
				0				Point to Point Mode (RS-232)
				1				Multi-Point (RS-485)
			0					CONTINUOUS (Point to Point Mode)
			1					COMMAND
		0						MESSAGE (Continuous MODE)
		1						CHARACTER (Continuous MODE)
	0							RS-232
	1							RS-485
0								ALWAYS 0, (Not Used)

EXAMPLE: To configure communication protocol and bus format as following: checksum excluded, no line feed, echo mode on, point to point, command mode and RS-232 protocol:

The command data is 00010100 BIN. = 14 HEX. Then send ***W1C14**

10. Data Format Commands (P, G, R, W)

10.14 LOCKOUT CONFIGURATION (“*Lck.CNF*”)

TABLE 10.14 LOCKOUT CONFIGURATION

BIT POSITION								LCK.CNF
7	6	5	4	3	2	1	0	
							0 1	SP1 LOCKOUT: UNLOCK LOCK
						0 1		SP2 LOCKOUT: UNLOCK LOCK
					0 1			AL1 LOCKOUT: UNLOCK LOCK
				0 1				AL2 LOCKOUT: UNLOCK LOCK
			0 1					INP<i>u</i>t LOCKOUT: UNLOCK LOCK
		0 1						RdG.CFG LOCKOUT: UNLOCK LOCK
	0 1							INP.CFG LOCKOUT: UNLOCK LOCK
0 1								MP.SC.OF LOCKOUT: UNLOCK LOCK

EXAMPLE: To prevent unauthorized modification of Setpoint 1 (SP1), Input type, Reading Configuration menu and Multi-Point Scale and Offset menu:

The command data is 10110001 BIN. = 14 HEX. Then send ***W01B1**

10. Data Format Commands (P, G, R, W)

10.15 LOCKOUT CONFIG. (“Lck.CNF”) and NORMAL COLOR (“N.COLOR”)

TABLE 10.15 LOCKOUT CONFIGURATION and NORMAL COLOR

BIT POSITION								Lck.CNF and N.COLOR
7	6	5	4	3	2	1	0	
							0 1	OUT.CNF LOCKOUT: UNLOCK LOCK
						0 1		SP.CNF LOCKOUT: UNLOCK LOCK
					0 1			AL.CNF LG LOCKOUT: UNLOCK LOCK
				0 1				COMM LOCKOUT: UNLOCK LOCK
			0 1					COLOR LOCKOUT: UNLOCK LOCK
		0/1						(Not Used)
0 0 1 1	0 1 0 1							NORMAL COLOR: GREEN NORMAL COLOR: RED NORMAL COLOR: AMBER (Not Used)

EXAMPLE: To prevent unauthorized access to Output Configuration menu, Communication menu and select Normal color of the LED's display as Green:

The command data is 00001001 BIN. = 09 HEX. Then send ***W0209**

10. Data Format Commands (P, G, R, W)

10.16 COLOR CONFIGURATION (“COLOR”)

TABLE 10.16 COLOR CONFIGURATION

BIT POSITION								COLOR
7	6	5	4	3	2	1	0	
						0	0	SP1 COLOR: HOLD
						0	1	SP1 COLOR: GREEN
						1	0	SP1 COLOR: RED
						1	1	SP1 COLOR: AMBER
				0	0			SP2 COLOR: HOLD
				0	1			SP2 COLOR: GREEN
				1	0			SP2 COLOR: RED
				1	1			SP2 COLOR: AMBER
		0	0					AL1 COLOR: HOLD
		0	1					AL1 COLOR: GREEN
		1	0					AL1 COLOR: RED
		1	1					AL1 COLOR: AMBER
0	0							AL2 COLOR: HOLD
0	1							AL2 COLOR: GREEN
1	0							AL2 COLOR: RED
1	1							AL2 COLOR: AMBER

EXAMPLE: To setup LED's display change color to RED then AMBER when reading reaches SP1 value then AL1 (SP3) value respectively, but hold the color for SP2 or AL2:

The command data is 00110010 BIN. = 32 HEX. Then send ***W0332**

10. Data Format Commands (P, G, R, W)

10.17 BLOCK A

BLOCK	COMMAND PREFIX	COMMAND SUFFIX (HEX)
A	R,W	40

NOTE: R,W means “R” or “W”

This block consists of ten (10) items and thirty bytes (60 ASCII characters):

TABLE 10.17 R/W40 (BLOCK A)

***W40**200000100001200000100001200000100001200000200000200000200000

HEX COMMAND SUFFIX	DESCRIPTION	BYTE NUMBER & ORDER	NUMBER OF BYTE	DEFAULT VALUE
26	Analog Out Offset	1, 2, 3	3	200000
17	Analog Out Scale	4, 5, 6	3	100001
25	Input Offset	7, 8, 9	3	200000
0B	Input Scale	10, 11, 12	3	100001
09	Reading Display Offset	13, 14, 15	3	200000
08	Reading Display Scale	16, 17, 18	3	100001
24	Setpoint 4 Value	19, 20, 21	3	200000
23	Setpoint 3 Value	22, 23, 24	3	200000
22	Setpoint 2 Value	25, 26, 27	3	200000
21	Setpoint 1 Value	28, 29, 30	3	200000

10. Data Format Commands (P, G, R, W)

10.17 BLOCK A continued

EXAMPLE: To configure meter working with the following order and desired options:

FUNCTIONS	DESIRED OPTIONS	EQUIVALENT HEX VALUE
Analog Out Offset	0	700000
Analog Out Scale	0.0001	A186A0
Input Offset	0	700000
Input Scale	1	6186A0
Display Offset	0	700000
Display Scale	1	6186A0
Setpoint 4 Value	+40000.	109C40
Setpoint 3 Value	+30000.	107530
Setpoint 2 Value	+20000.	104E20
Setpoint 1 Value	+10000.	102710

The command data is in order as following:

700000A186A070000006186A070000006186A0109C40107530104E20102710

Then send:

***W40**700000A186A070000006186A070000006186A0109C40107530104E20102710

10. Data Format Commands (P, G, R, W)

10.18 BLOCK B

BLOCK	COMMAND PREFIX	COMMAND SUFFIX (HEX)
B	R,W	41

NOTE: R,W means “R” or “W”

This block consists of 17 items and 19 bytes (38 ASCII characters):

TABLE 10.18 R/W41 (BLOCK B)

***W412A202020010115030000002000000894040000**

HEX COMMAND SUFFIX	DESCRIPTION	BYTE NUMBER & ORDER	NUMBER OF BYTE	DEFAULT VALUE
1E	Recognition Charater	1	1	2A
1F	Units of Measure	2, 3, 4	3	202020
20	Serial Delay	5	1	01
1A	RS-485 Device Address	6	1	01
18	COM.PAR and MOdbUS	7	1	15
13	NUM.dLy (Alarm Delay)	8	1	33
12	AL.CNF and AL.MOdE	9	1	00
11	AL.CNF	10	1	00
10	SP.CNF	11	1	00
05	INPUt and Rd.SC.OF	12	1	00
0C	CNt.by and dEC.Pt	13	1	00
16	OUt.CNF and Ad.RAtE	14	1	00
07	RDG.CNF	15	1	08
1C	BUS.FMt	16	1	94
1B	dAt.FMt	17	1	04
0E	FILtER	18	1	00
0A	INP.CNF	19	1	00

10. Data Format Commands (P, G, R, W)

10.18 BLOCK B continued

R/W41 (BLOCK B)

EXAMPLE: To configure meter working with following order and desired options:

FUNCTIONS	DESIRED OPTIONS	EQUIVALENT HEX. VALUE
Recognition Character	!	21
Units of Measure	mV	6D5600
Serial Delay	100msec.	02
RS-485 Device address	15	0F
COM.PAR & MODbUS	Comm. Parameter: (19.2k, none, 1) Modbus enabled	0E
NUM.dLy (Alarm Delay)	7 for Alarm 2, 9 for Alarm1	97
AL.CNF & AL.MoDE	AL1: Band Dev., latched; AL2: Process, latched	47
AL.CNF	AL1 & AL2 enabled, AL1:above, normal open, filtered; AL2: below, normal closed, unfiltered AL. Reset disabled at P2-11 rear connector.	9C
SP.CNF	SP1 & SP2 enabled and flashing; SP1: above, normal close; SP2: below, normal open,	2E
INPUt & Rd.SC.OF	0-100 Volt, and enable Rd.SC.OF	A3
CNt by & dEC.Pt	FFF.FFF	41
OUt.CNF & Ad.RAtE	Enabled Analog Output, 0-20mA and A2D conversion rate = 2	43
RdG.CNF	Rd.SC.OF direct format, Decimal Point active, Display Flashing at Alarm or Setpoint state and LED's display at high brightness level.	14
bUS.FMt	Checksum excluded, No line feed, Echo mode on, P-to-P Command mode, RS-485 protocol	54
DAt.FMt	Data String will include: Alarm / Peak / Valley / current filtered input value status and separated by line.	CF
FILtER	32	75
INP.CNF	Line Frequency - 60HZ, FAST (12/SEC) Reading Rate, UNIPOLAR, IN.SC.OF- ENABLE	1A

*The command data is in order as follows:

6D5600020F0E97479C2EA341431454CF

Then send: ***W41**6D5600020F0E97479C2EA341431454CF

10. Data Format Commands (P, G, R, W)

10.19 BLOCK C

BLOCK	COMMAND PREFIX	COMMAND SUFFIX (HEX)
C	R,W	42

NOTE: R,W means “R” or “W”

This block consists of 7 items and 10 bytes (20 ASCII characters):

TABLE 10.19 R/W42 (BLOCK C)

***W4200010014001400000000**

HEX COMMAND SUFFIX	DESCRIPTION	BYTE NUMBER & ORDER	NUMBER OF BYTE	DEFAULT VALUE
1D	SERCNT (Serial Count)	1, 2	2	0001
15	AL db (value)	3, 4	2	0014
14	SP db	5, 6	2	0014
04	(Reserved)	7	1	00
03	COLOR (Color Config)	8	1	00
02	LCK.CNF / N.COLOR	9	1	00
01	LCK.CNF	10	1	00

EXAMPLE: To configure meter working with following order and desired options:

FUNCTIONS	DESIRED OPTIONS	EQUIVALENT HEX. VALUE
SERCNT	Fast Rate (12readings/SEC)/hour or (12x60x60=43200: # of reading between transmission)	A8C0
AL db	0030	001E
SP db	0030	001E
(Reserved)	00	00
COLOR	LED's display changes color to RED then AMBER when reading reaches SP1 value then AL1 (SP3) value respectively, but hold the color for SP2 or AL2.	32
LCK.CNF / N.COLOR	Lock menus and Green for Normal LED's display color.	09
LCK.CNF	Prevent unauthorized modification of SP1, input type, RdG.CNF and MP.SC.OF menus	47

The command data is in order as follows: A8C0001E001E00320947

Then send: ***W42A8C0001E001E00320947**

10. Data Format Commands (P, G, R, W)

10.20 BLOCK D

Note R/W43, 44, 45, 46, 47, 48 are reserved by factory. It is not recommended that that the customer perform these commands.

TABLE 10.20 R/W43 (BLOCK D)

*To write default value:

W43000000000000000000000000800000000000800008000000080000000800000640

BYTE NUMBER & ORDER	DESCRIPTION	NUMBER OF BYTE	DEFAULT VALUE
1,2	Analog out mA Scale factor	2	0000
3,4	Analog out mA offset factor	2	0000
5,6	Analog out Volt Scale factor	2	0000
7,8	Analog out Volt offset factor	2	0000
9,10	QD-Online	2	0000
11,12	Cal. Current Scale	2	8000
13,14	Cal. Current Offset	2	0000
15,16	(Reserved)	2	0000
17,18	Cal. Bridge	2	8000
19,20	Cal. Ratio Scale	2	8000
21,22	Cal. Ratio Offset	2	0000
23,24	Cal. Quasi Scale	2	8000
25,26	Cal. Quasi Offset	2	0000
27,28	Cal. Howland Pump fine	2	8000
29,30	Cal. Howland Pump	2	0640

10. Data Format Commands (P, G, R, W)

10.21 R/W44 (BLOCK E)

To write default value:

W4480000000800000008000000080000000800000008000000080000000

TABLE 10.21 R/W44 (BLOCK E)

BYTE NUMBER & ORDER	DESCRIPTION	NUMBER OF BYTE	DEFAULT VALUE
1,2	500mV Scale	2	8000
3,4	500mV Offset	2	0000
5,6	5 V Scale	2	8000
7,8	5 V Offset	2	0000
9,10	50V Scale	2	8000
11,12	50V Offset	2	0000
13,14	1 V Scale	2	8000
15,16	1 V Offset	2	0000
17,18	10 V Scale	2	8000
19,20	10 V Offset	2	0000
21,22	100 V Scale	2	8000
23,24	100 V Offset	2	0000

10.22 R/W45 (BLOCK F)

To write default value: **W450000**

TABLE 10.22 R/W45 (BLOCK F)

BYTE NUMBER & ORDER	DESCRIPTION	NUMBER OF	DEFAULT VALUE
1,2	Cal. Quasi Offset	2	0000

10.23 R46

This command is for the channel one of A/D.

10.24 R47

This command is for the channel two of A/D

10.25 R48

This command is for the channel three of A/D

10. Data Format Commands (P, G, R, W)

10.26 R/W50

TABLE 10.23 R/W50

Hex Command Suffix	DESCRIPTION	Number of Byte	Default Value
50	1st Byte: MENU1 and MENU2 (SetColor.CNF) selector 2nd Byte: NUM.Pnt value of MP.SC.OF	2	0400

TABLE 10.24 R/W50 NUM.Pnt and MENU selection

BIT POSITION											FUNCTION					
15	14	13	12	11	10	9	8	7	6	5	4	3	2	1	0	
									0	0	0	0	0	0	0	2nd Byte: NUM.Pnt value of MP.SC.OF
						0	0									1st Byte: MENU1 & MENU2 (Set Color Config) GREEN REd AMbER (Not Used)
					0											MENU1 MENU2
					1											Normal default Operation/Menu selection disabled
																NEW Menu default UPDATE / Enabled Menu Type selection Initialization. (*)

(*) Menu Type Selection Initialization:

If the 1st byte of command data is set (remotely) 11111XXX, the selected menu (either **MENU1** or **MENU2**) will be written to the EEPROM and default configuration is automatically loaded. This 1st byte also resumes the state (00000XXX) of normal default operation or disables the Menu Type selection mode after the selected menu embedded.

EXAMPLE: To select **MENU1** from MENU2, send this following command:

*W50FC00

That will update the menu to new menu with default value items. The last two characters represent the default value of **NUM.Pnt** for **MP.SC.OF** (Multi-Point Scale & Offset).

10. Data Format Commands (P, G, R, W)

10.27 R/W51, R/W52, R/W53, R/W54, R/W55, R/W56, R/W57, R/W58, R/W59, R/W5A:

TABLE 10.25 *R/W5XXXXX

HEX COMMAND SUFFIX	DESCRIPTION 1st 3 bytes = Read0 value 2nd 3 bytes = Input0 value	NUMBER of BYTES	DEFAULT VALUE
51	MP.SC.OF Read/Input 0 values = Pointer 0	6	200000200000
52	MP.SC.OF Read/Input 0 values = Pointer 1	6	200000200000
53	MP.SC.OF Read/Input 0 values = Pointer 2	6	200000200000
54	MP.SC.OF Read/Input 0 values = Pointer 3	6	200000200000
55	MP.SC.OF Read/Input 0 values = Pointer 4	6	200000200000
56	MP.SC.OF Read/Input 0 values = Pointer 5	6	200000200000
57	MP.SC.OF Read/Input 0 values = Pointer 6	6	200000200000
58	MP.SC.OF Read/Input 0 values = Pointer 7	6	200000200000
59	MP.SC.OF Read/Input 0 values = Pointer 8	6	200000200000
5A	MP.SC.OF Read/Input 0 values = Pointer 9	6	200000200000

EXAMPLE: If Pointer 0 is read as with this command *R51 and the response is R51200000200000, it means that:

2nd 3 bytes is Input0 value = 200000
1st 3 bytes is Read0 value = 200000

EXAMPLE: To setup Multi-Point Scale & Offset with **NUM.Pnt** = 3 as desired as following and shown below:

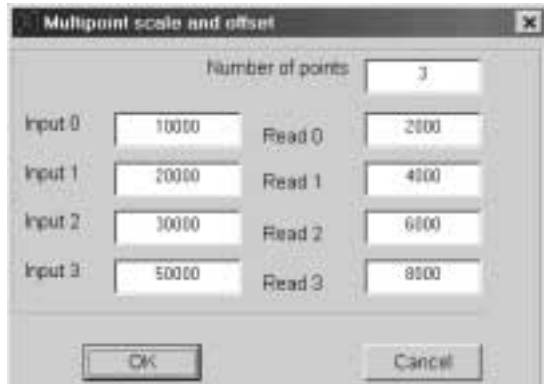

Converting the decimal values to hex. values and send the Write Commands as listed as following:

HEX. COMMAND SUFFIX	FOR	EQUIVALENT HEX. VALUE	FOR	EQUIVALENT HEX. VALUE	WRITE COMMAND
51	Read 0	1007D0	Input 0	102710	W511007D0102710
52	Read 1	100FA0	Input 1	104E20	W52100FA0104E20
53	Read 2	101770	Input 2	107530	W53101770107530
54	Read 3	101F40	Input 3	10C350	W54101F4010C350

To enter the values of Pointer, the Sign and Decimal point must follow the manner shown in **Table 10.26**.

10. Data Format Commands (P, G, R, W)

10.28 SET SIGN AND DECIMAL POINT FORMAT

Command suffixes “21”, “22”, “23” and “24” set the value of Setpoints 1, 2, 3 and 4 respectively (the last two often used as Alarm 1 and 2). Each setpoint is described by three bytes (six HEX-ASCII characters), with the sign and decimal point encoded in the MSN:

(Here, “FFFFFF” represents the 6 displayed decimal digits, the magnitude of the 20 least-significant bits of these 3 bytes.)

1. Bits 0 to 19 belong to the absolute value (99999 for negative values and 999999 for positive values)
2. Bits 20, 21, 22 belong to the decimalpoint as in **Table 10.26**
3. Bit 23 belongs to sign where 0 is positive and 1 is negative as in **Table 10.26**

TABLE 10.26 SETPOINT VALUES, BITS 23, 22, 21, AND 20

BIT PATTERN				SIGN AND DECIMAL POINT
23	22	21	20	
0	0	0	0	Not used
0	0	0	1	+FFFFF.
0	0	1	0	+FFFFF.F
0	0	1	1	+FFFF.FF
0	1	0	0	+FFF.FFF
0	1	0	1	+FF.FFFF
0	1	1	0	+F.FFFFF
0	1	1	1	Not used
1	0	0	0	Not used
1	0	0	1	-FFFFFF
1	0	1	0	-FFFFFF.F
1	0	1	1	-FFFF.FF
1	1	0	0	-FFF.FFF
1	1	0	1	-FF.FFFF
1	1	1	0	-F.FFFFF
1	1	1	1	Not used

The following 5 nibbles (HEX-ASCII characters) give the binary magnitude.

Note Since Setpoint value decimal point is directly related to the system decimal point (see **Section 10.3**), select the same decimal for setpoints as selected for system decimal point.

EXAMPLE: The computer inquires of meter #15 hex what value for Setpoint #3 is stored in EEPROM (usually the same value as in RAM):

“*15R23<CR>”, and if set for echo (“BUS.FMt”), the meter replies:

“15R23A12345<CR>”, where the magnitude is “12345” in hex, or “74565” in decimal, and the MSN “A”, from the **Table 10.28**, sets the final decimal value of Setpoint #3 as “-7456.5”.

10. Data Format Commands (P, G, R, W)

10.29 RS-485 METER “AddRES”

This “1A” command suffix uses 2 HEX-ASCII characters for the device address, but that number is limited to the 1 to 199 decimal range (many more numbers than the 32-device hardware limit).

EXAMPLE: The computer wants to renumber meter #15 HEX (#21 decimal) to #25 HEX(#37 decimal); it then puts the new address into EEPROM with:
“*15W1A25<CR>”

Which, if “BUS.FMt”, would be echoed by the meter with “15W1A<CR>”.

This new address would then be put into action by giving the meter a hard reset, “RESET2”, from the front-panel, by external contact closure (see **Section 10.12**), or by sending the reset with:
“*15Z04<CR>”.

That meter will no longer answer to the “15” hex address; it now responds commands preceded by “*25”.

10.30 NUMBER OF READINGS BETWEEN EACH TRANSMISSION (“SER CNT”)

The “1D” command suffix data is the number of readings between transmissions; this is used only for point-to-point continuous transmission. Four nibbles (2 bytes or 4 HEX-ASCII characters) are used; overflow detection limits the number of readings between transmissions to 59999 (decimal).

“1D” values reside only in EEPROM, so only “R/W” command letters apply.

EXAMPLE: If you were on SLOW (approximately 3 readings/second) and wanted a transmission every hour, the number of readings between transmissions would be approximately $3*60*60 = 10800$, or hex 2A30: to tell the meter, send:

“*W1D2A30<CR>”, which places the 2A30 into the EEPROM memory of the meter (add a Hard Reset, “*Z04<CR>” to move this into RAM). If you have set “BUS.FMt”, the meter will echo “W1D<CR>”.

10. Data Format Commands (P, G, R, W)

10.31 RECOGNITION CHARACTER (SER.RCG)

You can change the security code for commands with this “1E” command suffix; the ASCII table address (two HEX-ASCII characters) of the selected character is transmitted.

Valid character addresses are from 20 hex to 7F hex (32 to 127 decimal) with the exception of “^”, “A”, “E” characters.

EXAMPLE: To change the recognition character from “*” to “!” for all meters on the bus, send:

“*00W1E21<CR>”, which puts that new code into EEPROM (but not automatically into RAM), followed by “*00Z04<CR>”, which gives a hard reset to all the meters, moving the new code into RAM. All meters will now ignore commands preceded by “*”, and recognize those preceded with “!”.

10.32 UNITS OF MEASURE (SER.UOM)

When instructed with this “1F” command suffix, the meter will label its transmitted values with three letters representing the units of the measured quantity (these are for screen or printer labels, not for the meter display; the right-hand digit F, C or K units for temperature are selected by “RdG.CNF”, **Section 10.1**).

Each letter is represented by the two HEX-ASCII characters giving its ASCII table address, from “41” to “79” (all upper and lower case letters) or the <SP> address, “20”, for a total of six transmitted characters (do not select any control characters for units-of-measure).

When the desired units-of-measure to be printed have fewer than 3 characters, send the <SP> address (“20”) to put the blank(s) in the chosen spot(s).

Note that the units-of-measure letters transmitted in the “V01” response are in plain ASCII (one character each) in contrast with this command, where the six characters of the addresses are sent.

EXAMPLE: The computer requests the RAM setting for the measurements underway at meter #15 hex with:

“*15G1F<CR>”, and that meter, if “BUS.FMt”, responds with:

“15G1F6B5061<CR>”; the <data> here are “6B5061”, which is HEX-ASCII for “kPa” (kiloPascals).



“00” is equivalent to “nul” and meter will transmit nothing for units of measure if the first character is “0”.

10. Data Format Commands (P, G, R, W)

10.33 TX/RX TURNAROUND DELAY (SERIAL DELAY SER.dLy)

The four choices provided by the meter for this “20” command suffix only need two bits of storage, but the standard byte (two nibbles) is used, so that the MSN = 0.

Turn-around delay is normally used on half-duplex systems (e.g., RS-485), not on full duplex (for the meter, RS-232 or RS-422), but the chosen amount is applied to any of these by the meter. The delay can be useful in eliminating the effects of ringing, reflections or line drop.

TABLE 10.27.
SERIAL DELAY (“SER.dLy”)

BIT #		Milliseconds of Turnaround delay
0	0	0
0	1	30
0	2	100
0	3	300

EXAMPLE: The computer wants meter #15 hex to use a turn-around delay of 100 milliseconds:

“*15W2002<CR>”, and if set for echo with “BUS.FMt”, the meter replies:

“15W20<CR>”. If point-to-point (only one meter), the “15” address is not used. The chosen delay is now stored in the EEPROM. To put it into use (move to RAM), send a hard reset, “*15Z04<CR>”.

10.34 READING, INPUT, or OUTPUT SCALE FACTOR (“RdG SC”, “INP SC”, “Out SC”)

These items are 3 bytes each (6 HEX- ASCII characters) and their corresponding command suffixes are:

ITEM	COMMAND SUFFIX (HEX)
RdG SC	08
IN SC	0B
Out SC	17

All three scale factors can be calculated by the meter from entry of two data points (via pushbutton or diskette); only Reading Scale permits direct entry (to facilitate 1.00000 and other straight-forward values). Scale factor and Offset values, however, are stored separately inside the meter. If your scale/offset information is in the form of two data points (O2,I2 and O1,I1, where the O’s are the Outputs for the I’s, Inputs), then $SC = (O2-O1) / (I2-I1)$

This value is entered/read with these “08”, “0B” and “17” command suffixes, and also used in calculating the corresponding Offsets (see **Section 10.5**).



Note

True value for output scale factor is stored in its location in EEPROM. When the program is running, it combines this value with calibration scale of analog out board and stores new value in output scale’s RAM location (CALLED MODIFIED OUTPUT SCALE). Therefore, “P17” for this scale factor should be used very carefully (avoid using if possible). But with “G17”, the value of modified output scale factor can be read.

10. Data Format Commands (P, G, R, W)

10.34 READING, INPUT, or OUTPUT SCALE FACTOR continued

The most significant nibble of the scale factor data sets the decimal point (power of 10 multiplier) for the least-significant nineteen bits, which give the magnitude using a right-hand decimal point (decimal 499,999 full scale). The bit in between, #19, is the sign bit, “0” for “+” and “1” for “-”, which is OR’d with the magnitude to get the HEX value of the second nibble. The decimal-point code is given in **Table 10.28**. The figure “4” indicates the maximum value in that position and “x” is any chosen decimal digit.

Bit pattern information is as follows:

- 1) Bits 0 to 18 belong to the absolute value.
- 2) Bits 20, 21, 22, 23, belong to decimal point as shown in **Table 10.28**.
- 3) Bit number 19 belongs to the sign and is “0” for positive and “1” for negative.

TABLE 10.28. READING SCALE (“RdG SC”), INPUT SCALE (“INP SC”), AND OUTPUT SCALE (“Out SC”) BITS 23, 22, 21 AND 20

BIT NUMBER				DECIMAL NUMBER	POWER OF10 MULTIPLIER
23	22	21	20		
0	0	0	0	4xxxxx0.	1
0	0	0	1	4xxxxx.0	0
1	0	1	0	4xxxx.x0	-1
0	0	1	1	4xxx.xx0	-2
0	1	0	0	4xx.xxx0	-3
0	1	0	1	4x.xxxx0	-4
0	1	1	0	4.xxxxx0	-5
0	1	1	1	.4xxxxx0	-6
1	0	0	0	.04xxxxx0	-7
1	0	0	1	.004xxxxx0	-8
1	0	1	0	.0004xxxxx0	-9
1	0	1	1	.00004xxxxx0	-10
1	1	0	0	.000004xxxxx0	-11
1	1	0	1	.0000004xxxxx0	-12
1	1	1	0	.00000004xxxxx0	-13
1	1	1	1	.000000004xxxxx0	-14

EXAMPLE: Desired reading scale factor is 123.45. The magnitude is 12345, which is hex 03039. The polarity is negative, so the 19th bit is a “1”, giving hex “80000”; when OR’2 with the magnitude, the least-significant 5 nibbles are hex “83039”.

The decimal-point is two places to the left of the right-hand position (e.g., of the 6-digit display). The decimal point is thus -2, which is a MSB of 3 from the **Table 10-28**.

OR’d with the other 5 nibbles, hex “383039”, write this factor to the EEPROM of meter hex #15 with: *15W08383039<CR>. The meter will echo 15W08<CR> if you have set “BUS.FMt”.

10. Data Format Commands (P, G, R, W)

10.35 READING OFFSET (“RdG OF”), INPUT OFFSET (“INP OF”), or OUTPUT OFFSET (“OUT OF”)

These 3 (“09”, “25” and “26” command suffixes) all use the same 3-byte (6-nibble or 6 character) format. The most significant bit is the sign bit, “=0” for a positive value, “=1” for a negative value. The other 3 bits of the MSN are used for decimal point (referenced to the right-hand display dp position) as given in the **Table 10.29**. The remaining 5 nibbles (20 bits) are the magnitude (resolution one ppm).

Your data might be in the form of two data points (O2,I2 and O1,I1); since the meter stores this information as separate scale and offset values, it is necessary to calculate the offset:

$$OF = O1 - SC * I1,$$

where the scale factor SC is that calculated by the equation in **Section 10.34**.

In **Table 10.29**, “9” represents the maximum leading digit, and “x” is any desired decimal.

Bit pattern information is as follows:

- 1) Bits 0 to 19 belong to the absolute value (99999 when value is negative and 999999 when value is positive).
- 2) Bits 20, 21, 22, belong to decimal point as shown in **Table 10.29**.
- 3) Bit number 20 is assigned to sign and is equal to “0” for positive and “1” for negative values.

TABLE 10.29. READING OFFSET (“RdG OF”), INPUT OFFSET (“INP OF”), AND OUTPUT OFFSET (“OUT OF”), BITS 22, 21 AND 20

BIT NUMBER			DECIMAL NUMBER	POWER OF 10 MULTIPLIER
22	21	20		
0	0	0	9xxxxx00.	2
0	0	1	9xxxxx0.	1
0	1	0	9xxxxx.0	0
0	1	1	9xxxx.x0	-1
1	0	0	9xxx.xx0	-2
1	0	1	9xx.xxx0	-3
1	1	0	9x.xxxx0	-4
1	1	1	9.xxxxx0	-5

EXAMPLE: The computer requests the current display (reading) offset value from the meter hex #15 with: *15G09<CR>.

10. Data Format Commands (P, G, R, W)

10.35 READING OFFSET, INPUT OFFSET, or OUTPUT OFFSET continued

The meter (set to echo with "BUS.FMt") responds: 15G09D17618<CR>. To translate this, the 6 data nibbles are stripped out: "D17618". The most significant bit (of the "D" nibble) is a "1", so the offset is negative. Decimal point is at position 4.

The magnitude, HEX "17618", is decimal 95768, so the meter's decimal reading offset is -95.768.

 True value for Output Offset is stored in its location in EEPROM. When program is running, it combines this value with calibration offset of the Analog Output Board and stores new value (called Modified Output Offset) in Output Offset's RAM location. Therefore, "P26" for this offset should be used very carefully (avoid using if possible). But, with "G26", value of modified output offset can be read.

10.36 SETPOINT 1 AND 2 HYSTERESIS ("SP db")

Command Suffix "14" uses two bytes (four nibbles, or four characters) for this binary positive-only value. Both setpoints use this same hysteresis, applied 50% on either side of the respective setpoint. This value is not kept in RAM (only in the EEPROM), so that only "R" and "W" commands apply.

EXAMPLE: If the computer wants to know the hysteresis value stored by meter #15 hex, it sends:

"*15R14<CR>", to which the meter replies:
"15R141A90<CR>" if it was programmed to echo with "BUS.FMt" and had decimal hysteresis of 6,800 counts.

 Maximum allowable value for hysteresis is 9999 counts.

10.37 ALARM (SP 3 AND SP 4) HYSTERESIS ("AL db")

Identical with **Section 10.36**, suffix "15" commands use two bytes (four characters) for this binary positive-only value. Both alarms use this same hysteresis, applied 100% on the inactive side of the respective alarm point (setpoint), so that you get fast alarm action and slower exit from that alarm. This value is not kept in RAM; "R" and "W" interact with the EEPROM.

EXAMPLE: The computer sends "*15W1A90<CR>", giving both alarms the hysteresis value of hex 6800 Counts.

 Maximum allowable value for hysteresis is 9999 counts.



WARRANTY/DISCLAIMER

OMEGA ENGINEERING, INC. warrants this unit to be free of defects in materials and workmanship for a period of **one (1) year** from the date of purchase. In addition to OMEGA's standard warranty period, OMEGA Engineering will extend the warranty period for **four (4) additional years** if the warranty card enclosed with each instrument is returned to OMEGA.

If the unit malfunctions, it must be returned to the factory for evaluation. OMEGA's Customer Service Department will issue an Authorized Return (AR) number immediately upon phone or written request. Upon examination by OMEGA, if the unit is found to be defective, it will be repaired or replaced at no charge. OMEGA's WARRANTY does not apply to defects resulting from any action of the purchaser, including but not limited to mishandling, improper interfacing, operation outside of design limits, improper repair, or unauthorized modification. This WARRANTY is VOID if the unit shows evidence of having been tampered with or shows evidence of having been damaged as a result of excessive corrosion; or current, heat, moisture or vibration; improper specification; misapplication; misuse or other operating conditions outside of OMEGA's control. Components which wear are not warranted, including but not limited to contact points, fuses, and triacs.

OMEGA is pleased to offer suggestions on the use of its various products. However, OMEGA neither assumes responsibility for any omissions or errors nor assumes liability for any damages that result from the use of its products in accordance with information provided by OMEGA, either verbal or written. OMEGA warrants only that the parts manufactured by it will be as specified and free of defects. OMEGA MAKES NO OTHER WARRANTIES OR REPRESENTATIONS OF ANY KIND WHATSOEVER, EXPRESS OR IMPLIED, EXCEPT THAT OF TITLE, AND ALL IMPLIED WARRANTIES INCLUDING ANY WARRANTY OF MERCHANTABILITY AND FITNESS FOR A PARTICULAR PURPOSE ARE HEREBY DISCLAIMED. LIMITATION OF LIABILITY: The remedies of purchaser set forth herein are exclusive, and the total liability of OMEGA with respect to this order, whether based on contract, warranty, negligence, indemnification, strict liability or otherwise, shall not exceed the purchase price of the component upon which liability is based. In no event shall OMEGA be liable for consequential, incidental or special damages.

CONDITIONS: Equipment sold by OMEGA is not intended to be used, nor shall it be used: (1) as a "Basic Component" under 10 CFR 21 (NRC), used in or with any nuclear installation or activity; or (2) in medical applications or used on humans. Should any Product(s) be used in or with any nuclear installation or activity, medical application, used on humans, or misused in any way, OMEGA assumes no responsibility as set forth in our basic WARRANTY/DISCLAIMER language, and, additionally, purchaser will indemnify OMEGA and hold OMEGA harmless from any liability or damage whatsoever arising out of the use of the Product(s) in such a manner.

RETURN REQUESTS/INQUIRIES

Direct all warranty and repair requests/inquiries to the OMEGA Customer Service Department. BEFORE RETURNING ANY PRODUCT(S) TO OMEGA, PURCHASER MUST OBTAIN AN AUTHORIZED RETURN (AR) NUMBER FROM OMEGA'S CUSTOMER SERVICE DEPARTMENT (IN ORDER TO AVOID PROCESSING DELAYS). The assigned AR number should then be marked on the outside of the return package and on any correspondence.

The purchaser is responsible for shipping charges, freight, insurance and proper packaging to prevent breakage in transit.

FOR WARRANTY RETURNS, please have the following information available BEFORE contacting OMEGA:

1. Purchase Order number under which the product was PURCHASED,
2. Model and serial number of the product under warranty, and
3. Repair instructions and/or specific problems relative to the product.

FOR NON-WARRANTY REPAIRS, consult OMEGA for current repair charges. Have the following information available BEFORE contacting OMEGA:

1. Purchase Order number to cover the COST of the repair,
2. Model and serial number of product, and
3. Repair instructions and/or specific problems relative to the product.

OMEGA's policy is to make running changes, not model changes, whenever an improvement is possible. This affords our customers the latest in technology and engineering.

© Copyright 2003 OMEGA ENGINEERING, INC. All rights reserved. This document may not be copied, photocopied, reproduced, translated, or reduced to any electronic medium or machine-readable form, in whole or in part, without the prior written consent of OMEGA ENGINEERING, INC.

TRADEMARK NOTICE: ®, **omega.com**® and  **OMEGA**® are Trademarks of OMEGA ENGINEERING, INC.

PATENT NOTICE: This product is covered by one or more of the following patents: U.S. Pat. No. Des. 336,895; 5,274,577; 6,243,021 / CANADA 2052599; 2052600 / ITALY 1249456; 1250938 / FRANCE BREVET No. 91 12756 / SPAIN 2039150; 2048066 / UK PATENT No. GB2 249 837; GB2 248 954 / GERMANY DE 41 34398 C2. The "Meter Bezel Design" is a Trademark of NEWPORT Electronics, Inc. Used under License. Other US and International Patents pending or applied for.

Where Do I Find Everything I Need for Process Measurement and Control? **OMEGA...Of Course!**

Shop on line at www.omega.com

TEMPERATURE

- ☑ Thermocouple, RTD & Thermistor Probes, Connectors, Panels & Assemblies
- ☑ Wire: Thermocouple, RTD & Thermistor
- ☑ Calibrators & Ice Point References
- ☑ Recorders, Controllers & Process Monitors
- ☑ Infrared Pyrometers

PRESSURE, STRAIN AND FORCE

- ☑ Transducers & Strain Gauges
- ☑ Load Cells & Pressure Gauges
- ☑ Displacement Transducers
- ☑ Instrumentation & Accessories

FLOW/LEVEL

- ☑ Rotameters, Gas Mass Flowmeters & Flow Computers
- ☑ Air Velocity Indicators
- ☑ Turbine/Paddlewheel Systems
- ☑ Totalizers & Batch Controllers

pH/CONDUCTIVITY

- ☑ pH Electrodes, Testers & Accessories
- ☑ Benchtop/Laboratory Meters
- ☑ Controllers, Calibrators, Simulators & Pumps
- ☑ Industrial pH & Conductivity Equipment

DATA ACQUISITION

- ☑ Data Acquisition & Engineering Software
- ☑ Communications-Based Acquisition Systems
- ☑ Plug-in Cards for Apple, IBM & Compatibles
- ☑ Datalogging Systems
- ☑ Recorders, Printers & Plotters

HEATERS

- ☑ Heating Cable
- ☑ Cartridge & Strip Heaters
- ☑ Immersion & Band Heaters
- ☑ Flexible Heaters
- ☑ Laboratory Heaters

ENVIRONMENTAL MONITORING AND CONTROL

- ☑ Metering & Control Instrumentation
- ☑ Refractometers
- ☑ Pumps & Tubing
- ☑ Air, Soil & Water Monitors
- ☑ Industrial Water & Wastewater Treatment
- ☑ pH, Conductivity & Dissolved Oxygen Instruments