



LDX-4

 **User's Guide**

Shop online at

omega.com
Ω OMEGA®

omega.com

e-mail: info@omega.com

**For latest product manuals:
omegamanual.info**





OMEGAnet® On-Line Service www.omega.com	Internet e-mail info@omega.com
--	--

Servicing North America:

USA: One Omega Drive, Box 4047
ISO 9001 Certified Stamford CT 06907-0047
Tel: (203) 359-1660 FAX: (203) 359-7700
e-mail: info@omega.com

Canada: 976 Bergar
Laval (Quebec) H7L 5A1, Canada
Tel: (514) 856-6928 FAX: (514) 856-6886
e-mail: info@omega.ca

For immediate technical or application assistance:

USA and Canada: Sales Service: 1-800-826-6342 / 1-800-TC-OMEGA®
Customer Service: 1-800-622-2378 / 1-800-622-BEST®
Engineering Service: 1-800-872-9436 / 1-800-USA-WHEN®
TELEX: 996404 EASYLINK: 62968934 CABLE: OMEGA

Mexico: En Español: (001) 203-359-7803 e-mail: espanol@omega.com
FAX: (001) 203-359-7807 info@omega.com.mx

Servicing Europe:

Benelux: Postbus 8034, 1180 LA Amstelveen, The Netherlands
Tel: +31 (0)20 3472121 FAX: +31 (0)20 6434643
Toll Free in Benelux: 0800 0993344
e-mail: sales@omegaeng.nl

Czech Republic: Frystatska 184, 733 01 Karviná, Czech Republic
Tel: +420 (0)59 6311899 FAX: +420 (0)59 6311114
Toll Free: 0800-1-66342 e-mail: info@omegashop.cz

France: 11, rue Jacques Cartier, 78280 Guyancourt, France
Tel: +33 (0)1 61 37 2900 FAX: +33 (0)1 30 57 5427
Toll Free in France: 0800 466 342
e-mail: sales@omega.fr

Germany/Austria: Daimlerstrasse 26, D-75392 Deckenpfronn, Germany
Tel: +49 (0)7056 9398-0 FAX: +49 (0)7056 9398-29
Toll Free in Germany: 0800 639 7678
e-mail: info@omega.de

United Kingdom: One Omega Drive, River Bend Technology Centre
ISO 9002 Certified Northbank, Irlam, Manchester
M44 5BD United Kingdom
Tel: +44 (0)161 777 6611 FAX: +44 (0)161 777 6622
Toll Free in United Kingdom: 0800-488-488
e-mail: sales@omega.co.uk

It is the policy of OMEGA to comply with all worldwide safety and EMC/EMI regulations that apply. OMEGA is constantly pursuing certification of its products to the European New Approach Directives. OMEGA will add the CE mark to every appropriate device upon certification.

The information contained in this document is believed to be correct, but OMEGA Engineering, Inc. accepts no liability for any errors it contains, and reserves the right to alter specifications without notice.

WARNING: These products are not designed for use in, and should not be used for, human applications.

LDX-4

M-1128/0505

1.0: Index

Section	Title	Page	Section	Title	Page
1.0	Index	2	4.6.1	Voltage Connections.	11
2.0	Safety Information	3	4.6.2	Current Connections	12
3.0	Introduction	5	4.7	Using an EMC Cable Gland	13
3.1	LDX-4 Enhancements	5	5.0	Setting up the Transducer and LDX-4	14
4.0	Installation	6	5.1	Links Explained	15
4.1	Mounting	6	5.2	Basic Procedure	16
4.2	Operational Environment	7	5.3	Sensitivity and the X2, X4, DIV2 Links	20
4.2.1	Residential, Commercial & Light Industrial Environments	7	6.0	Half-Bridge Version	20
4.2.2	Industrial Environments	7	7.0	Specifications	22
4.3	Electrical Connections	8	7.1	Electrical	23
4.4	Connecting the Transducer	10	7.2	Mechanical and Connections	24
4.5	Connecting the Power Supply	11	7.3	Environmental.	24
4.6	Connecting the Signal Out	11	7.4	Notes	25

LDX-4

2.0: Safety Information

Terms in this Manual

WARNING statements identify conditions or practices that could result in personal injury or loss of life.

CAUTION statements identify conditions or practices that could result in damage to the equipment or other property.

Symbols in this manual



This symbol indicates where applicable cautionary or other information is to be found.

WARNINGS:

Do not operate in explosive atmosphere

To avoid explosion, do not operate this equipment in an explosive atmosphere.

Safety Critical Environments

This equipment is not intended for use in a safety critical environment.

CAUTION:

Low Voltage

This equipment operates at below the SELV and is therefore outside the scope of the Low Voltage Directive.

This equipment is designed to work from a low voltage DC supply. Do not operate this equipment outside of specification.

2.0: Safety Information

CAUTION:

Electrostatic Discharge

This equipment is susceptible to **ESD** (Electrostatic Discharge) when being installed or adjusted, or whenever the case cover is removed. To prevent ESD related damage, handle the conditioning electronics by its case and do not touch the connector pins. During installation, follow the guidelines below.

- Ensure all power supplies are turned off.
- If possible, wear an ESD strap connected to ground. If this is not possible, discharge yourself by touching a metal part of the equipment into which the conditioning electronics is being installed.
- Connect the transducer and power supplies with the power switched off.
- Ensure any tools used are discharged by contacting them against a metal part of the equipment into which the conditioning electronics is being installed.
- During setting up of the conditioning electronics, make link configuration changes with the power supply turned off. Avoid touching any other components.
- Make the final gain and offset potentiometer adjustments, with power applied, using an appropriate potentiometer adjustment tool or a small insulated screwdriver.

3.0: Introduction

The LDX-4 MK2 is a development of the original LDX-4. It is a compact conditioning module powered from a single DC supply. Adjustable gain and zero controls are provided for use with the complete range of Omega transducers. The unit is of robust construction, housed in a die cast aluminium box providing a substantial degree of mechanical protection. The LDX-4 MK2 incorporates its own voltage regulation for operation from 10-30 VDC and can provide outputs of up to ± 10 V together with ± 20 mA.

3.1: LDX-4 Enhancements

The LDX-4 MK2 has been designed as a form, fit and function replacement for the original LDX-4, but with several enhancements.

- Wider gain range, allowing ALL Omega transducers to be connected without the need for attenuation resistors.
- Up to ± 10 VDC and ± 20 mA are available for all gain settings.
- Fixed and variable offsets make setting of uni-polar output easier.
- Gain and offset adjustment are fully independent.
- Selectable transducer excitation frequency.
- Selectable transducer load resistances.
- Selection between forward and reverse connection.
- Fully CE Compliant.
- Half-Bridge transducers can now be accommodated with simple plug wiring changes.*

* For half-bridge only variant see section 6.0.

4.0: Installation

4.1: Mounting

The LDX-4 may be mounted in a variety of ways and in any attitude. Ensure that there is enough space for the cover to be removed to allow for internal adjustments. Space should also be allowed for the transducer connector, EMC glands (if fitted) and cabling. It is recommended that the LDX-4 case be connected to earth or chassis. This earth connection is not a safety earth, but is part of the overall electrical screening scheme.

Underside Mounting

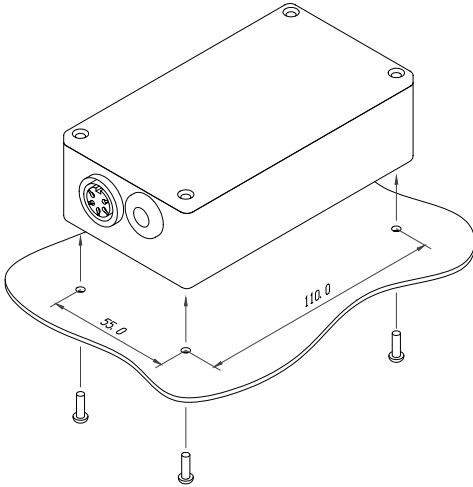

Top-Side Mounting

Note: If replacing LDX-4 MKI a retrofit mounting kit is available if repositioning holes is not possible.

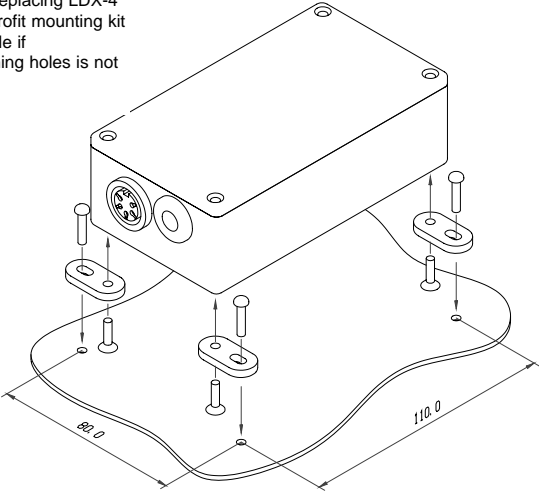

4.0: Installation (continued)

4.2: Operational Environment

This section discusses the type of installation required depending on the electrical environment.

4.2.1: Residential, Commercial and Light Industrial Environments

Typically, this will be an office, laboratory or industrial environment where there is no equipment likely to produce high levels of electrical interference, such as welders or machine tools.

Connections may be made using twisted, unshielded wire. This is a cost effective option and will give good performance in this environment.

Standard equipment wire such as 7/0.2 (24AWG) can be twisted together as required. Standard data cable such as generic CAT5 UTP will also give good performance.

4.2.2: Industrial Environments

Typically, this will be an industrial environment where there is equipment likely to produce high levels of electrical interference, such as welders, machine tools, cutting and stamping machines.

Connections should be made using shielded cable. Braided or foil shielded cables may be used. The cable shield should be connected to the LDX-4 case at cable entry point. The case of the LDX-4 should be connected to a local ground. An EMC cable gland is recommended. This is supplied with the LDX-4.

When selecting the type of wire or cable to be used, consider the following parameters:

- Shielding.
- Conductor size (resistance).
- Mechanical aspects such as flexibility and robustness.

This is not a complete list. Installations may require other special cable characteristics.

4.0: Installation (continued)

4.3: Electrical Connections

The LDX-4 requires three connections.

1. Transducer.
2. Power Supply.
3. Output Signal, Voltage or Current.

A small hole should be made in the grommet prior to passing the wires through. If a screened cable is to be used, an EMC cable gland is recommended (see section 4.7).

For best performance in electrically noisy environments, the case of the LDX-4 should be connected to a local earth. This can be achieved via the mounting bracket. This earth connection is not a safety earth, but is part of the overall electrical screening scheme.

The wiring layout arrangements are similar for LDX-4 fitted with EMC glands and screened cable.

Separate Power Supply and Signal Out wires

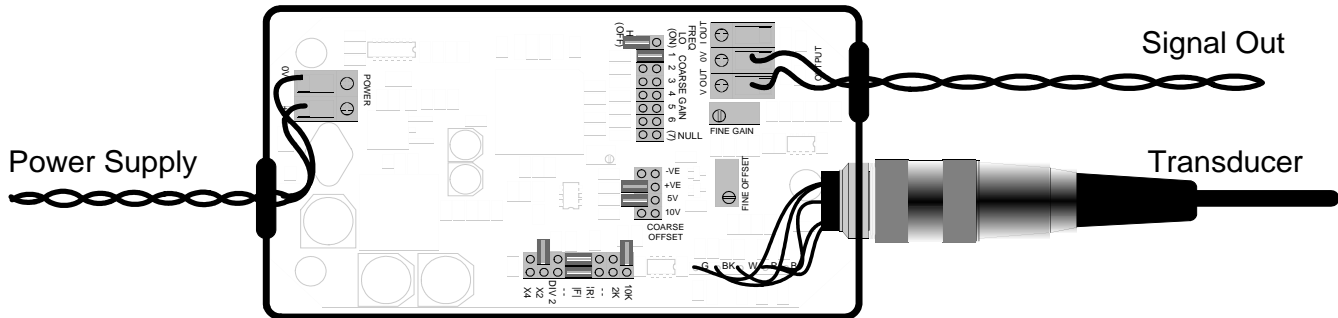

LDX-4

4.0: Installation (continued)

4.3: Electrical Connections

Power Supply and Signal Out wires from one end only

Connections to the power supply should be routed to one side as shown. This helps to reduce interference between power supply wires and the more sensitive parts of the circuitry.

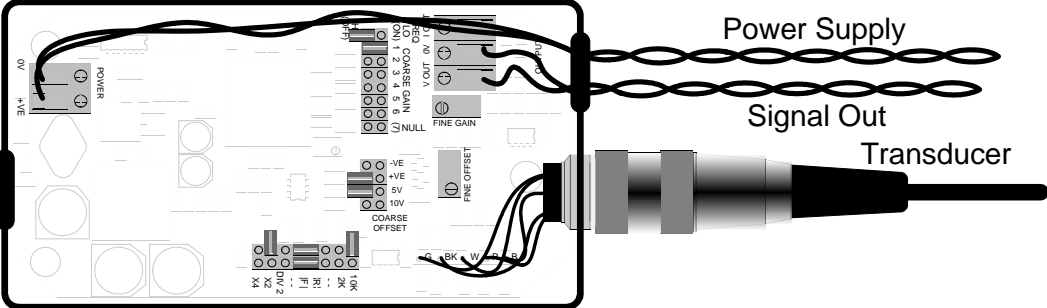

4.0: Installation (continued)

4.4: Connecting the Transducer

Transducers fitted with a 5-pin DIN plug are simply screwed into the case mounted socket. Transducers not fitted with a plug should be wired to the plug supplied. For the half-bridge only variant see section 6.0.

LVDT Electrical Connections	
Red and Blue	Energising
Green and White	Signal
Yellow	Secondary Centre Tap
Red and White	In Phase for Inward Displacement
Black	Transducer Body Ground

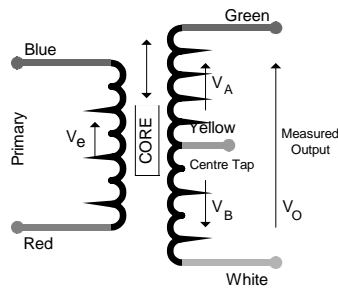

Half-Bridge Electrical Connections	
Red and Blue	Energising
Yellow	Signal
Red and Yellow	In Phase for Inward Displacement
Black	Transducer Body Ground

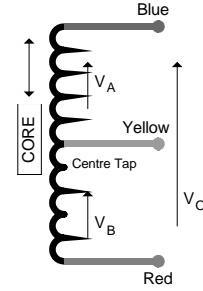

Standard LVDT Gauging Probe Plug Connections

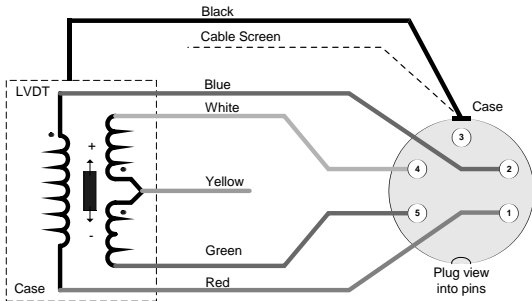

Note 1: + indicates inward movement of the tip.
 Note 2: The transducer body may be disconnected from the cable screen by cutting the black wire inside the connector

Standard Half-Bridge Gauging Probe Plug Connections

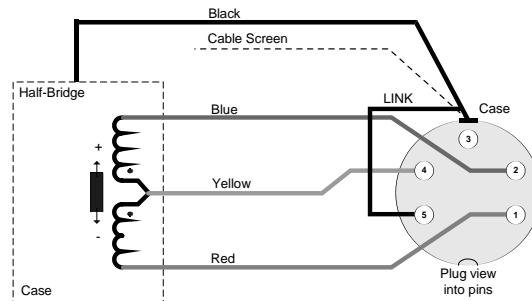

Note 1: + indicates inward movement of the tip.
 Note 2: The transducer body may be disconnected from the cable screen by cutting the black wire inside the connector

4.0: Installation (continued)

4.5: Connecting the Power Supply

The LDX-4 requires a dc power supply in the range 10-30 V. A fully regulated supply is not required, but the voltage at the input to the LDX-4 must remain within specification. Ideally, the 0 V at the power supply should not be connected to earth or the chassis, as this would result in ground loops being formed. The 0 V supply, 0 V signal and case are all internally connected together at the LDX-4.

4.6: Connecting the Signal Out

The output signal may be voltage or current.

4.6.1: Voltage Connections

Voltage can easily be monitored using a variety of instrumentation such as voltmeters. Voltage drops along wires contribute to measurement errors, so care must be taken when using long cable lengths (100 m for example). High impedance instruments are more prone to interference.

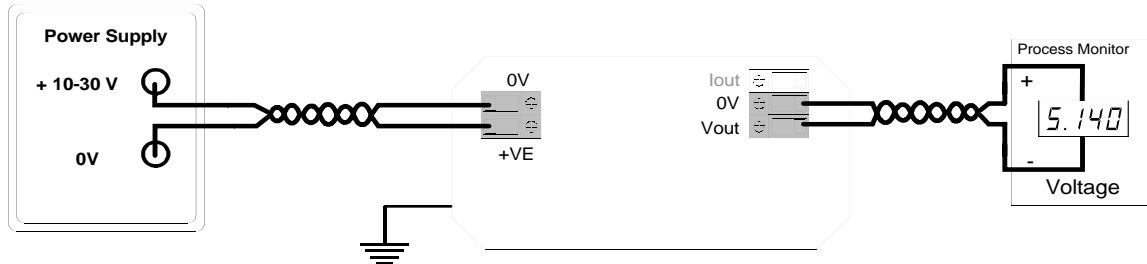

The signal 0 V should always be used as reference. If power supply 0 V is used, then error voltages may be introduced.

4.0: Installation (continued)

4.6.2: Current Connections

Current output requires the use of purposely designed current input instrumentation. Current output is more suitable for transmitting over longer distances because current is not lost due to wiring resistance. Additionally, with a low impedance, a current loop is less likely to pick up noise.

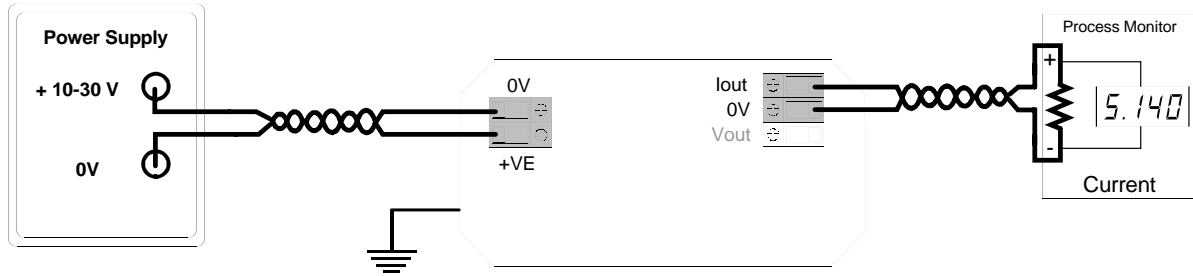

The total loop resistance (resistance of measuring equipment and wiring) must not exceed specification.

Note: The LDX-4 is not loop-powered, so a power supply must not be used in-line with the current output.

4.0: Installation (continued)

4.7: Using an EMC Cable Gland

To ensure the cable screen is properly connected to the LDX-4 case, an EMC cable gland should be used. This is supplied as an optional extra. The diagrams below assume a single 4-way cable is being used. Remove the grommet and fit the cable gland as shown below.

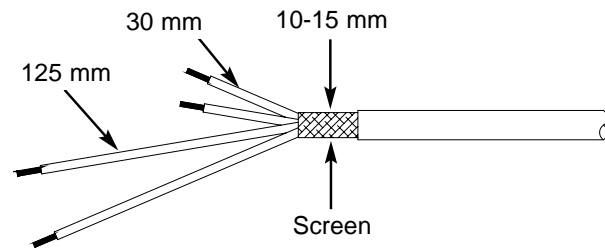
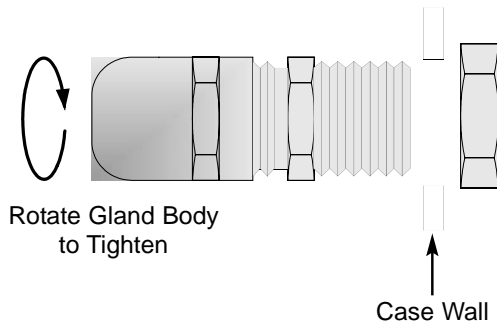

- Prepare cable as shown.
- Slide the Dome nut, sealing ring and plastic insert over cable.
- Fold and roll the screen back over itself to form a lump.
- Push cable into gland body followed by the plastic insert (ensure anti-rotation slots engage), sealing ring and Dome nut.
- Ensure all components are properly seated before tightening the dome nut.

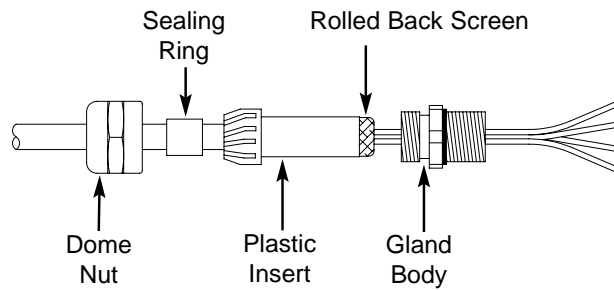

5.0: Setting up the Transducer and LDX-4

The LDX-4 may be set-up with output signals anywhere within a ± 10 VDC or ± 20 mA range. Typical outputs are ± 10 Vdc, ± 5 VDC, 0-10 VDC and 4-20 mA. These procedures apply to voltage and current output.

Voltage and current output are available at the same time, although they cannot be individually adjusted. Either voltage or current should be chosen as the calibration reference.

All outputs use 0 V signal as the signal reference.

A list of standard link settings is available, see section 5.2.



CAUTION:

During installation and adjustment, the top of the enclosure has to be removed for access to user adjustments. At this time, standard ESD handling precautions for electronic equipment should be followed.

5.0: Setting up the Transducer and LDX-4 (continued)

5.1: Option Links - Explained

The table below and subsequent diagrams explain the link functions and show the factory setting.

Link	Description	Options	Standard Setting
Course Gain	Sets the basic gain	1 link on Positron 1 to 6	Link ON Position 1
Fine Gain	Adjustment between course gain ranges	Potentiometer Adjustment	Mid Position
Course Offset	Shifts the output by a fixed amount	Link ON -VE or +VE and Link ON 5V or 10V No offset - Link Parked	No offset - Links Parked
Fine Offset	Fine trim around any fixed offset	Potentiometer Adjustment	Mid Position
(7) Null	Used during set-up to null output	ON, OFF	OFF
Freq.	Selects transducer primary frequency	Lo - ON, Hi - Parked	Hi Freq. - Link Parked
Input Resistance	Sets transducer secondary load	100kΩ Parked, 10kΩ - ON, 2kΩ - ON	100KΩ - Link Parked
Polarity (FR)	Enables output signal direction change	2 Links across Forward or Reverse	F Position - 2 Link ON
Input Gain	Input Gain of x1, x2, x4 or divide 2	X1 - Parked, X2 - ON, X4 - ON, DIV2 - ON	Link parked on X2

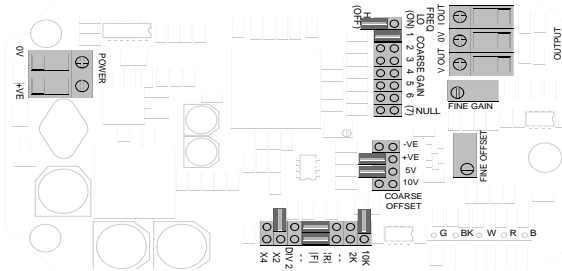
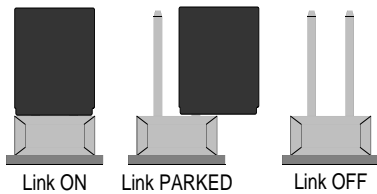

5.0: Setting up the Transducer and LDX-4 (continued) _____

5.2: Basic Procedure

To set-up the LDX-4, some basic steps should be followed.

The following steps describe a typical setting procedure and applies to most applications. Other procedures may be used as appropriate.

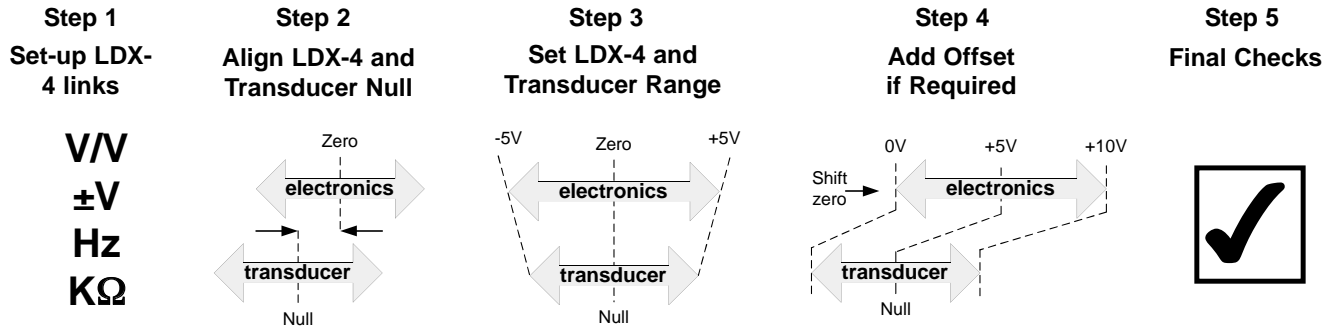

For a bi-polar output i.e. ± 10 VDC or ± 20 mA, follow steps 1 to 3.

For a uni-polar output i.e. 0-10 V, 0-20 mA or 4-20 mA, follow steps 1 to 4.

In either case, step 5 (final checks) should be followed on the completion of the set-up.

5.0: Setting up the Transducer and LDX-4 (continued) _____

5.2: Basic Procedure

STEP 1 - Set-up LDX-4 Links

If the transducer characteristics are known, set the frequency and input resistance links as required. If the transducer characteristics are not known, the standard link settings should be used.

If your transducer is known to be outside of the standard sensitivity range, the X2 or DIV2 links will have to be used. See section 5.3.

STEP 2 - Align LDX-4 Null and Transducer Null

Any electrical offset in the LDX-4 is removed. The transducer position is adjusted so that transducer and LDX-4 nulls are aligned.

Null the LDX-4.

1. Put the Gain link on position (7) as shown. This allows any electronics offset in the output stage to be removed.
2. Adjust the Fine Offset control to give as near to zero output as practical.

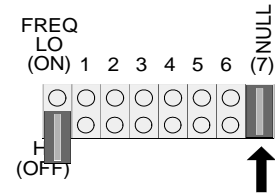

Null the transducer.

1. Replace the Gain link to the original position.
2. Adjust the position of the transducer to give as near to zero output as practical. This is the centre of the mechanical range.

If the transducer cannot be centered for practical reasons an offset will remain within the system. There may be noticeable interaction between Gain and Offset adjustment. This does not prevent the OD4 being set-up, however several iterations may be required when adjusting Gain and Offset. Please contact your supplier if guidance is required.

5.0: Setting up the Transducer and LDX-4 (continued) _____

5.2: Basic Procedure

STEP 3 - Setting Bi-Polar Full-scale Output

1. Move the transducer to the position where maximum LDX-4 output is required.
2. If the polarity of the output is wrong, move the Polarity (FR) links to the R position (see link diagram).

Normal Output Polarity

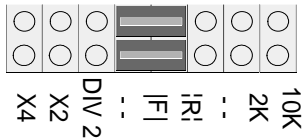

Reverse Output Polarity

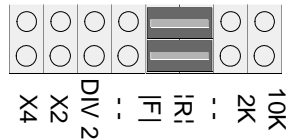

3. Move the RANGE link between 1 and 6 until the LDX-4 output is near the required value.
4. Adjust the Fine Gain control to give the required output.
5. A bi-polar output has now been set, proceed to step 5. If a uni-polar output is required, proceed to step 4.

Example: ± 10 VDC is required from a ± 1 mm transducer. Set the transducer to +1 mm and set the output to 10 V.

If your transducer is known to be outside of the standard sensitivity range, the X2, X4 or DIV2 links will have to be used. See section 5.3.

5.0: Setting up the Transducer and LDX-4 (continued) _____

5.2: Basic Procedure

STEP 4 - Setting Uni-polar Full-Scale Output (adding an offset)

1. Move the transducer to the null position. LDX-4 output will be 0 V or 0 mA.
2. Apply offset using the +VE, -VE, 5 V and 10 V links and then adjust the Fine Offset control to set the offset precisely.
3. Perform final checks, step 5.

Example: 0-10 V is required for a ± 1 mm transducer. Set the transducer to give ± 5 V over the full range and then, with the transducer at null, add +5 V offset. Adjust the Fine Offset control to give 5 V. When the transducer is moved to the +1 mm position, the output will be +10 V.

Example: 4-20 mA is required for a ± 1 mm transducer. Set the transducer to give ± 8 mA over the full range and then, with the transducer at null, add +2.5 V (approx. 5 mA) offset. Adjust the Fine Offset control to give +12 mA. When the transducer is moved to the +1 mm position, the output will be +20 mA.

STEP 5 - Final Checks

Ensure that the calibration is correct by moving the transducer across the required mechanical range, checking calibration points. Fine adjustment can be made if required.

It may only be possible to set the output accurately at the two calibration points. This is due to non-linearity within the transducer.

5.0: Setting up the Transducer and LDX-4 (continued)

5.3: Transducer Sensitivity and the X2, X4, DIV2 Link

The LDX-4 compensates for changes in primary signal amplitude by producing an internal error signal that is the ratio between the primary and secondary signals. If the transducer output signal is too high or too low, errors may occur that can degrade the performance of the LDX-4 / transducer combination. For these transducers, the X2, X4 or DIV2 input gain link must be used.

Transducer Full Range Output

In general, transducer sensitivity is quoted as **mV/V/mm**

Where: **mV** is the output of the transducer
V is the primary voltage
mm is the mechanical position of the transducer from null (usually mid mechanical range).

To get the transducer Full Range Output, multiply all three together.

Example: GP911-1 sensitivity is 210 mV/V/mm
GP911-1 range is ± 1 mm
LDX-4 primary voltage 3 V
Transducer Full Range Output = $210 \times 3 \times 1 = 630$ mV (0.63 V)

Set the X2, X4, DIV2 link as shown in the table below.

Transducer Full Range Output	Input Gain Link Setting
400 mV FR to 2500 mV FR	Standard Range - Link Parked on X2
2500 mV FR to 5000 mV FR	High Transducer Output - Link ON DIV2
150 mV FR to 400 mV FR	Low Transducer Output - Link ON X2
55 mV FR to 150 mV FR	Very Low Transducer Output - Link ON X4

6.0: Half-Bridge only Variant

This is a half-bridge optimised variant of the standard product. The excitation frequency is higher (see specification) and the transducer input connector is wired to accept half-bridge transducers with standard connections.

6.1: Connecting the transducer

The 5-pin DIN plug is screwed into the case mounted socket. Transducers not fitted with a plug should be wired to the plug supplied. LVDT transducers cannot be connected to this input.

Standard Half-Bridge Gauging Probe Plug Connections

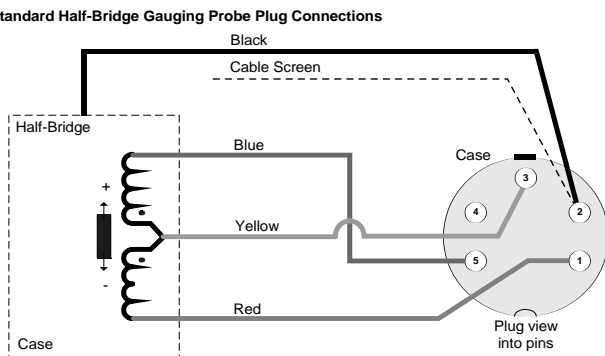

Note 1: + indicates inward movement of the tip.

Note 2: The transducer body may be disconnected from the cable screen by cutting the black wire inside the connector

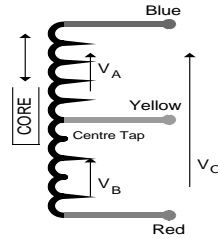

Half-Bridge Electrical Connections

Red and Blue	Energising
Yellow	Signal
Red and Yellow	In Phase for Inward Displacement
Black	Transducer Body Ground

6.2: Setting up the Half-Bridge Transducer

The setting up procedure is the same as LVDT transducers. See section 5. The sensitivity of half-bridge transducers is generally lower than for LVDT types, the x2 and x4 gain position may have to be used.

7.0: Specifications

7.1: Electrical

Parameter	Value	Comments
Power Supply		
Typical Voltage / Current	24 VDC at 55 mA	
Voltage Range	10 to 30 VDC	
Current Range	140 mA at 10 V to 50 mA at 30 V	
Transducer Excitation		
Energising Voltage	3 Vrms nominal	see note 1
Energising Frequency	2.5 kHz (Lo) or 5 kHz (Hi) nominal 10 kHz (Lo) or 13 kHz (Hi)	link selectable Half-Bridge version only
Energising Current	30 mA max.	
Transducer Signal Input		
Input Signal Range	Standard 400 to 2500 mV FR Special DIV2 2500 to 500 mV FR x2 150 to 400 mV FR x4 55 to 150 mV FR	6 gain ranges (applies to LVDT only) see note 2
Input Load Resistance	2, 10, 10 kΩ	link selectable
Options	Forward and Reverse LVDT Input Half-Bridge Input	link selectable standard special plug wiring or half-bridge version only

7.0: Specifications (continued)

7.1: Electrical

Parameter	Value	Comments
Signal Output		
Output Voltage Range	up to ± 10 VDC into $1\text{ k}\Omega$	see notes 3 and 4
Output Residual Noise	<1 mVrms	
Output Current	up to ± 20 mA into $150\ \Omega$ load	see note 5
Output Offset		
Coarse	± 5 VDC (approx 10 mA) fixed	link selectable
	± 10 VDC (approx 20 mA) fixed	link selectable
Fine	± 2.8 VDC (approx 5.6 mA)	Variable (adds to fixed offsets)
Temperature Coefficient Gain	$<0.01\%$ FRO/ $^{\circ}\text{C}$	
Temperature Coefficient Offset	$<0.01\%$ FRO/ $^{\circ}\text{C}$	
Warm-Up	15 minutes recommended	
Linearity	$<0.1\%$ FRO	
Bandwidth (-3dB)	500 Hz typical	
Protection (see note 6)		
Power Supply	Reverse connection protected	
Inputs and Outputs	Short circuit protected Transient and ESD Protected	
Certification (see note 7)		
Immunity	BS EN61000-6-2:2001	Immunity for Industrial Environments
Emissions	BS EN61000-6-3:2001	Emission for Residential, commercial and light-industrial environments

7.0: Specifications (continued)

7.2: Mechanical and Connections

Parameter	Value	Comments
Transducer	5-pin circular DIN	
Power Supply	Internal Terminal Block	
Output Signal	Internal Terminal Block	
Enclosure - Size	120 x 65 x 40 mm	Excluding connectors
Weight	300 g (0.66 lbs) approx.	
Material of Case	Die-Cast Zinc Alloy (painted)	

7.3: Environmental

Parameter	Value	Comments
Operating Temperature Range	0 - 60°C	
Storage Temperature Range	-20 - 85°C	
IP Rating	IP40	

7.0: Specifications (continued)

7.4: Notes

1. Primary voltage absolute value and drift is not specified. The LDX-4 uses ratiometric techniques to compensate for primary voltage drift.
2. The way in which the LDX-4 functions means a special configuration must be used for transducers outside of the standard range. This is selectable by links. The majority of Omega LVDT transducers are within the standard range. See section 5.
3. LDX-4 can drive into a 1 k Ω load but this offers no advantage. 10-100 k Ω is recommended.
4. Output voltage range can be adjusted as required anywhere within this range by using a combination of gain and offset, for example. ± 10 VDC, ± 5 VDC, 0-5 VDC, 0-10 VDC, 4-20 mA.
5. Current output may be used at the same time as voltage output. Calibration of voltage and current cannot be individually adjusted.
6. Protection applies to the product when fully installed according to the user manual. During installation the top of the enclosure has to be removed for access to user adjustments. At this time standard ESD handling precautions for electronic equipment should be followed.
7. The LDX-4 complies with the toughest electrical emissions and immunity regulations. Compliance requires installation according to the user manual. Compliance does not guarantee performance as the installation environment may be outside of test specification limits. The flexibility of LDX-4 means it can be installed in a variety of ways according to user requirements. Simple installations with short non-screened cables will meet the lesser light-industrial immunity regulations. Heavy industrial installations, especially with longer cables, will need more careful installation with screened cables.

WARRANTY/DISCLAIMER

OMEGA ENGINEERING, INC. warrants this unit to be free of defects in materials and workmanship for a period of **13 months** from date of purchase. OMEGA's Warranty adds an additional one (1) month grace period to the normal **one (1) year product warranty** to cover handling and shipping time. This ensures that OMEGA's customers receive maximum coverage on each product.

If the unit malfunctions, it must be returned to the factory for evaluation. OMEGA's Customer Service Department will issue an Authorized Return (AR) number immediately upon phone or written request. Upon examination by OMEGA, if the unit is found to be defective, it will be repaired or replaced at no charge. OMEGA's WARRANTY does not apply to defects resulting from any action of the purchaser, including but not limited to mishandling, improper interfacing, operation outside of design limits, improper repair, or unauthorized modification. This WARRANTY is VOID if the unit shows evidence of having been tampered with or shows evidence of having been damaged as a result of excessive corrosion; or current, heat, moisture or vibration; improper specification; misapplication; misuse or other operating conditions outside of OMEGA's control. Components which wear are not warranted, including but not limited to contact points, fuses, and triacs.

OMEGA is pleased to offer suggestions on the use of its various products. However, OMEGA neither assumes responsibility for any omissions or errors nor assumes liability for any damages that result from the use of its products in accordance with information provided by OMEGA, either verbal or written. OMEGA warrants only that the parts manufactured by it will be as specified and free of defects. OMEGA MAKES NO OTHER WARRANTIES OR REPRESENTATIONS OF ANY KIND WHATSOEVER, EXPRESS OR IMPLIED, EXCEPT THAT OF TITLE, AND ALL IMPLIED WARRANTIES INCLUDING ANY WARRANTY OF MERCHANTABILITY AND FITNESS FOR A PARTICULAR PURPOSE ARE HEREBY DISCLAIMED. LIMITATION OF LIABILITY: The remedies of purchaser set forth herein are exclusive, and the total liability of OMEGA with respect to this order, whether based on contract, warranty, negligence, indemnification, strict liability or otherwise, shall not exceed the purchase price of the component upon which liability is based. In no event shall OMEGA be liable for consequential, incidental or special damages.

CONDITIONS: Equipment sold by OMEGA is not intended to be used, nor shall it be used: (1) as a "Basic Component" under 10 CFR 21 (NRC), used in or with any nuclear installation or activity; or (2) in medical applications or used on humans. Should any Product(s) be used in or with any nuclear installation or activity, medical application, used on humans, or misused in any way, OMEGA assumes no responsibility as set forth in our basic WARRANTY/DISCLAIMER language, and, additionally, purchaser will indemnify OMEGA and hold OMEGA harmless from any liability or damage whatsoever arising out of the use of the Product(s) in such a manner.

LDX-4

RETURN REQUESTS/INQUIRIES

Direct all warranty and repair requests/inquiries to the OMEGA Customer Service Department. **BEFORE RETURNING ANY PRODUCT(S) TO OMEGA, PURCHASER MUST OBTAIN AN AUTHORIZED RETURN (AR) NUMBER FROM OMEGA'S CUSTOMER SERVICE DEPARTMENT (IN ORDER TO AVOID PROCESSING DELAYS).** The assigned AR number should then be marked on the outside of the return package and on any correspondence.

The purchaser is responsible for shipping charges, freight, insurance and proper packaging to prevent breakage in transit.

FOR WARRANTY RETURNS, please have the following information available **BEFORE** contacting OMEGA:

1. Purchase Order number under which the product was PURCHASED,
2. Model and serial number of the product under warranty, and
3. Repair instructions and/or specific problems relative to the product.

FOR NON-WARRANTY REPAIRS, consult OMEGA for current repair charges. Have the following information available **BEFORE** contacting OMEGA:

1. Purchase Order number to cover the COST of the repair,
2. Model and serial number of the product, and
3. Repair instructions and/or specific problems relative to the product.

OMEGA's policy is to make running changes, not model changes, whenever an improvement is possible.

This affords our customers the latest in technology and engineering.

OMEGA is a registered trademark of OMEGA ENGINEERING, INC.

© Copyright 2004 OMEGA ENGINEERING, INC. All rights reserved. This document may not be copied, photocopied, reproduced, translated, or reduced to any electronic medium or machine-readable form, in whole or in part, without the prior written consent of OMEGA ENGINEERING, INC.

M-1128/0505

Where Do I Find Everything I Need for Process Measurement and Control?

OMEGA...Of Course!

Shop online at www.omega.com

TEMPERATURE

- Thermocouple, RTD & Thermistor Probes, Connectors, Panels & Assemblies
- Wire: Thermocouple, RTD & Thermistor
- Calibrators & Ice Point References
- Recorders, Controllers & Process Monitors
- Infrared Pyrometers

PRESSURE, STRAIN AND FORCE

- Transducers & Strain Gauges
- Load Cells & Pressure Gauges
- Displacement Transducers
- Instrumentation & Accessories

FLOW/LEVEL

- Rotameters, Gas Mass Flowmeters & Flow Computers
- Air Velocity Indicators
- Turbine/Paddlewheel Systems
- Totalizers & Batch Controllers

pH/CONDUCTIVITY

- pH Electrodes, Testers & Accessories
- Benchtop/Laboratory Meters
- Controllers, Calibrators, Simulators & Pumps
- Industrial pH & Conductivity Equipment

DATA ACQUISITION

- Data Acquisition & Engineering Software
- Communications-Based Acquisition Systems
- Plug-in Cards for Apple, IBM & Compatibles
- Datalogging Systems
- Recorders, Printers & Plotters

HEATERS

- Heating Cable
- Cartridge & Strip Heaters
- Immersion & Band Heaters
- Flexible Heaters
- Laboratory Heaters

ENVIRONMENTAL MONITORING AND CONTROL

- Metering & Control Instrumentation
- Refractometers
- Pumps & Tubing
- Air, Soil & Water Monitors
- Industrial Water & Wastewater Treatment
- pH, Conductivity & Dissolved Oxygen Instruments