

5

To Configure Temperature (If You Selected MANU for Temperature Compensation):

1. Press **MENU** until the controller displays.
2. Press **►T/mV**. The controller displays the actual constant temperature.
3. Press **▲/pH** to change the value of the flashing digit.
4. Press **►T/mV** to advance to the next digit.
5. Repeat steps 3 and 4 until the controller displays the desired value.
6. Press **MENU** to select the value shown. The unit displays.

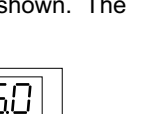
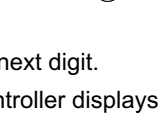
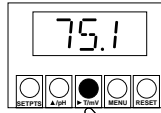
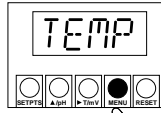

To Perform Calibration (2-Point Example:)

1. Place your electrode into a pH 7 buffer solution.
2. Press **►T/mV**. The controller displays:
3. Press **►T/mV**. The controller displays the previous value of IN 1.
4. Press **►T/mV** again. The controller displays the buffer solution's pH value. Allow enough time for the electrode to settle.

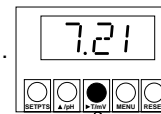
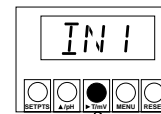

6

5. Press **MENU** until the controller displays. indicating that the value is stored.
6. Rinse the electrode with distilled water and place it into a pH4 or pH10 solution.
7. Press **►T/mV**. The controller displays the previous value of IN 2.
8. Press **►T/mV** again. The controller displays the buffer solution's pH value. Allow enough time for the electrode to settle.
9. Press **MENU**. The controller displays:

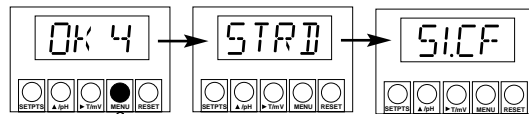
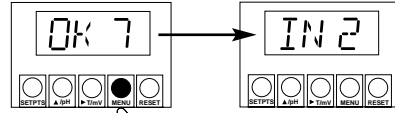

For a 3-point calibration, you follow the same procedure used in 2-point calibration, except you place the electrode into three buffer solutions in this order: pH4, pH7, and then pH10.

10. Press **RESET** twice. The controller displays: and then the current pH value. Your controller is now up and running.

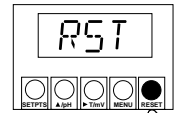

It is the policy of OMEGA to comply with all worldwide safety and EMC/EMI regulations that apply. OMEGA is constantly pursuing certification of its products to the European New Approach Directives. OMEGA will add the CE mark to every appropriate device upon certification.

WARNING: These products are not designed for use in, and should not be used for, patient connected applications.

The information contained in this document is believed to be correct but OMEGA Engineering, Inc. accepts no liability for any errors it contains, and reserves the right to alter specifications without notice.

TRADEMARK NOTICE: *omega.com*[™], and **OMEGA**, are trademarks of OMEGA Engineering, Inc.



WARRANTY/DISCLAIMER

OMEGA ENGINEERING, INC. warrants this unit to be free of defects in materials and workmanship for a period of **one (1) year** from the date of purchase. In addition to OMEGA's standard warranty period, OMEGA Engineering will extend the warranty period for **four (4) additional years** if the warranty card enclosed with each instrument is returned to OMEGA.

If the unit should malfunction, it must be returned to the factory for evaluation. OMEGA's Customer Service Department will issue an Authorized Return (AR) number immediately upon phone or written request. Upon examination by OMEGA, if the unit is found to be defective it will be repaired or replaced at no charge. OMEGA's WARRANTY does not apply to defects resulting from any action of the purchaser, including but not limited to mishandling, improper interfacing, operation outside of design limits, improper repair, or unauthorized modification. This WARRANTY is VOID if the unit shows evidence of having been tampered with or shows evidence of being damaged as a result of excessive corrosion; or current, heat, moisture or vibration; improper specification; misapplication; misuse or other operating conditions outside of OMEGA's control. Components which wear are not warranted, including but not limited to contact points, fuses, and triacs.

OMEGA is pleased to offer suggestions on the use of its various products. However, OMEGA neither assumes responsibility for any omissions or errors nor assumes liability for any damages that result from the use of its products in accordance with information provided by OMEGA, either verbal or written. OMEGA warrants only that the parts manufactured by it will be as specified and free of defects. OMEGA MAKES NO OTHER WARRANTIES OR REPRESENTATIONS OF ANY KIND WHATSOEVER, EXPRESSED OR IMPLIED, EXCEPT THAT OF TITLE, AND ALL IMPLIED WARRANTIES INCLUDING ANY WARRANTY OF MERCHANTABILITY AND FITNESS FOR A PARTICULAR PURPOSE ARE HEREBY DISCLAIMED. LIMITATION OF LIABILITY: The remedies of purchaser set forth herein are exclusive and the total liability of OMEGA with respect to this order, whether based on contract, warranty, negligence, indemnification, strict liability or otherwise, shall not exceed the purchase price of the component upon which liability is based. In no event shall OMEGA be liable for consequential, incidental or special damages.

CONDITIONS: Equipment sold by OMEGA is not intended to be used, nor shall it be used: (1) as a "Basic Component" under 10 CFR 21 (NRC), used in or with any nuclear installation or activity; or (2) in medical applications or used on humans. Should any Product(s) be used in or with any nuclear installation or activity, medical application, used on humans, or misused in any way, OMEGA assumes no responsibility as set forth in our basic WARRANTY / DISCLAIMER language, and additionally, purchaser will indemnify OMEGA and hold OMEGA harmless from any liability or damage whatsoever arising out of the use of the Product(s) in such a manner.

RETURN REQUESTS / INQUIRIES

Direct all warranty and repair requests/inquiries to the OMEGA Customer Service Department. **BEFORE RETURNING ANY PRODUCT(S) TO OMEGA, PURCHASER MUST OBTAIN AN AUTHORIZED RETURN (AR) NUMBER FROM OMEGA'S CUSTOMER SERVICE DEPARTMENT (IN ORDER TO AVOID PROCESSING DELAYS).** The assigned AR number should then be marked on the outside of the return package and on any correspondence. The purchaser is responsible for shipping charges, freight, insurance and proper packaging to prevent breakage in transit.

FOR **WARRANTY** RETURNS, please have the following information available **BEFORE** contacting OMEGA:

1. P.O. number under which the product was PURCHASED,
2. Model and serial number of the product under warranty, and
3. Repair instructions and/or specific problems relative to the product.

FOR **NON-WARRANTY** REPAIRS, consult OMEGA for current repair charges. Have the following information available **BEFORE** contacting OMEGA:

1. P.O. number to cover the COST of the repair,
2. Model and serial number of product, and
3. Repair instructions and/or specific problems relative to the product.

OMEGA's policy is to make running changes, not model changes, whenever an improvement is possible. This affords our customers the latest in technology and engineering.

OMEGA is a registered trademark of OMEGA ENGINEERING, INC. © Copyright 2006 OMEGA ENGINEERING, INC. All rights reserved. This document may not be copied, photocopied, reproduced, translated, or reduced to any electronic medium or machine-readable form, in whole or in part, without prior written consent of OMEGA ENGINEERING, INC.

PATENT NOTICE: The "Meter Case Bezel Design" is a trademark of NEWPORT Electronics, Inc., registered in the U.S. USED UNDER LICENSE. This product is covered by one or more of the following patents: U.S. Pat. No. Des. 336,895; 5,274,577 / CANADA 2052599; 2052600 / ITALY 1249456; 1250938 / FRANCE BREVET No. 91 12756 / SPAIN 2039150; 2048066 / UK PATENT No. GB2 249 837; GB2 248 954 / GERMANY DE 41 34398 C2. OTHER INTERNATIONAL PATENTS PENDING.



**PHCN-37
MICROPROCESSOR-BASED
pH CONTROLLER**



OMEGAnet® On-Line Service www.omega.com	Internet e-mail info@omega.com
--	--

Servicing North America:

USA: One Omega Drive, P.O. Box 4047
Stamford CT 06907-0047
TEL: (203) 359-1660 FAX: (203) 359-7700
ISO 9001 Certified e-mail: info@omega.com

Canada: 976 Bergar
Laval (Quebec) H7L 5A1
TEL: (514) 856-6928 FAX: (514) 856-6886
e-mail: info@omega.ca

For immediate technical or application assistance:

USA and Canada: Sales Service: 1-800-826-6342 / 1-800-TC-OMEGA®
Customer Service: 1-800-622-2378 / 1-800-622-BEST®
Engineering Service: 1-800-872-9436 / 1-800-USA-WHEN®

Mexico and Latin American: TEL: (001) 203-359-7803 FAX: (001) 203-359-7807
e-mail: espanol@omega.com

Servicing Europe:

Benelux: TEL: +31 20 3472121 FAX: +31 20 6434643
Toll Free in Benelux: 0800 0993344
e-mail: sales@omegaeng.nl

Czech Republic: Frystatska 184, 733 01 Karviná
TEL: +420 59 6311899 FAX: +420 59 6311114
e-mail: info@omegashop.cz

France: TEL: +33 1 61 37 29 00 FAX: +33 1 30 57 54 27
Toll Free in France: 0800 466 342
e-mail: sales@omega.fr

Germany/Austria: Daimlerstrasse 26, D-75392 Deckenpfronn, Germany
TEL: +49 7056 9398-0 FAX: +49 7056 9398-29
Toll Free in Germany: 0800 639 7678
e-mail: info@omega.de

United Kingdom: One Omega Drive
River Bend Technology Centre
Northbank, Irlam Manchester M44 5BD United Kingdom
TEL: +44 161 777 6611 FAX: +44 161 777 6622
Toll Free in England: 0800 488 488
e-mail: sales@omega.co.uk
ISO 9001 Certified

START HERE

Using This Quick Start Manual

Use this Quick Start manual to set up your pH Controller and begin operation. Information is provided on how to:

- Mount the controller
- Connect ac Power
- Connect a pH electrode
- Calibrate the controller prior to use

For complete information on this controller, refer to the Operator's Manual.

Before You Begin

In addition to the meter and the related parts, you will need the following items to set up your meter:

- ac power, as listed on meter's ID/Power Label
- pH electrode (with BNC input connector)
- 1/8" flat blade screwdriver

Mount the Unit

1. Cut a panel opening using the dimensions shown to the right.
2. Position the unit in the opening, making sure the front bezel gasket is flush to the panel.
3. Slide on mounting bracket to secure.

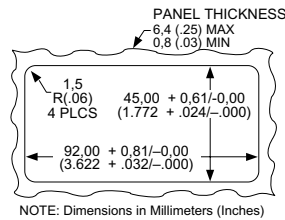

Connect ac Power

Warning: Do not connect AC power to your device until you have completed all input and output connections. This device must only be installed by a specially trained electrician with corresponding qualifications. Failure to follow all instructions and warnings may result in injury!

1. Remove the panel at the back of the unit.
2. Locate the TB1 connector.
3. Insert the correct wire in each terminal as shown in the following figure and tighten the lockdown screws.
4. Tug gently on the wires to verify the connections.

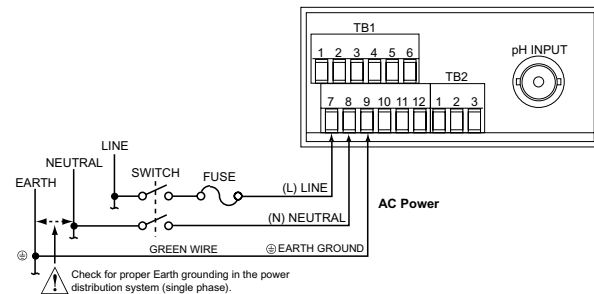

2

Connect the pH Electrode

1. Secure the pH electrode to the pH input BNC connector on the back of the controller.

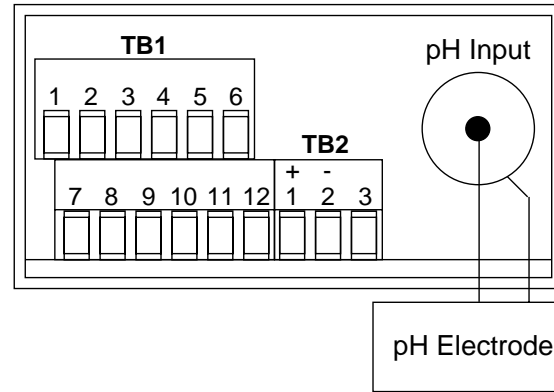

2. If you are using automatic temperature compensation (ATC), connect the RTD as shown below.

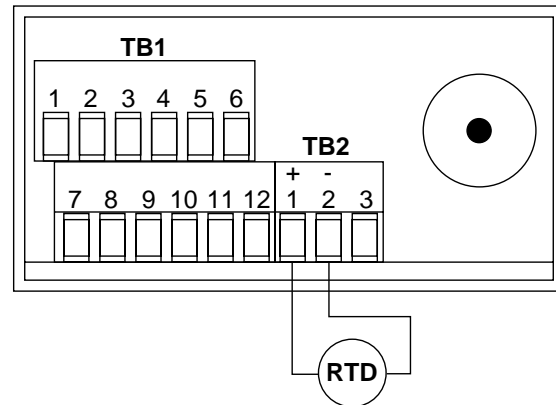

Apply Power

1. Apply ac power to the unit.
- The unit initializes, flashing the following messages: *RST*, *PH*, *INIT*. Then a pH value appears.
2. Verify that a value appears. If not:

- Remove ac power.
- Verify the TB1 power connections.
- Check your power source.
- Apply ac power again.

3

To Select Temperature Compensation Mode:

1. Press **MENU**. The controller displays:
2. Press **T/mV** to display the current setting.
3. Press **▲/pH** to change to the desired setting. Choices are:

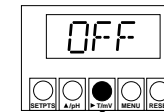
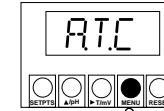

OFF = the controller uses a constant 25°C for temperature compensation.

MANU = the controller uses a manually entered value for temperature compensation.

METR = the controller uses the RTD input for automatic temperature compensation.

4. Press **MENU** to select the temperature compensation setting shown. The controller displays:

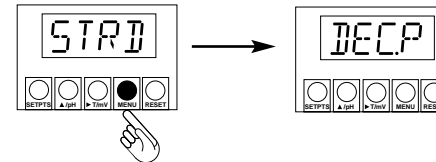

To Set The Decimal Point Position:

1. If it's not already shown, press **MENU** until the controller displays *DECP*.
2. Press **T/mV**. The controller displays:
3. Press **▲/pH** to move the decimal point to the desired location. The choices are *FFFF*, *FFFF*, or *FFFF*.
4. Press **MENU** to select the decimal point position shown. The controller displays:

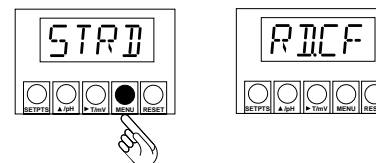
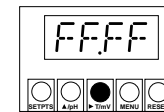

4

Calibrate the Controller:

1. If it's not already shown, press **MENU** until the controller displays *R1CF*.
2. Press **T/mV**. The controller displays *R1 = 2* or *R1 = 3* (2 or 3 point calibration).

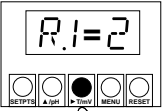

3. Press **▲/pH** to select the desired calibration type.

4. Press **T/mV** to display *R2 = F* or *R2 = C* (temperature unit of F or C).

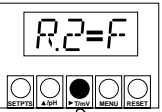

5. Press **▲/pH** to select the desired temperature unit.

6. Press **MENU** to select the calibration. The unit displays:

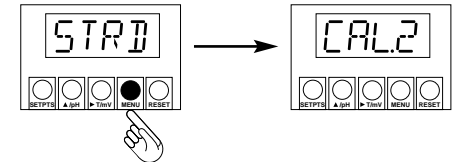

7. Proceed with Calibration depending on Temperature Compensation Setting:

- If you choose OFF, go to "To Perform Calibration" section.
- If you choose METR, ensure the RTD is properly connected and go to "To Perform Calibration" section.
- If you choose MANU, configure temperature as described in the next section.