

2 YEAR
WARRANTY

Ω OMEGA® **User's Guide**



Shop online at
omega.comSM

e-mail: info@omega.com
For latest product manuals:
www.omegamanual.info

CN616 SERIES
1/4 DIN Economical 6-Zone
PID Temperature Controllers



omega.com info@omega.com

Servicing North America:

**U.S.A.
Headquarters:**

Omega Engineering, Inc.

Toll-Free: 1-800-826-6342 (USA & Canada only)

Customer Service: 1-800-622-2378 (USA & Canada only)

Engineering Service: 1-800-872-9436 (USA & Canada only)

Tel: (203) 359-1660

Fax: (203) 359-7700

e-mail: info@omega.com

For Other Locations Visit omega.com/worldwide

Table of Contents

SECTION	PAGE
SECTION 1 INTRODUCTION	2
1.1 Description	2
1.2 Features	2
1.3 Models	3
1.4 Overview of operation	3
SECTION 2 RS-232 COMMUNICATIONS	7
2.1 Description	7
2.2 RS-232 Cable Connections	7
2.3 Operating Protocol	8
2.4 RS-232 PC Screens	12
SECTION 3 INSTALLATION	15
3.1 Unpacking	15
3.2 Mounting	15
3.3 Outline Dimensions	16
3.4 Wiring the Power Circuit	16
3.5 Changing Line Voltage Setting	17
3.6 Sensor Placement	17
SECTION 4 PARTS OF THE CONTROLLER	18
4.1 Front of the Controller	18
4.2 Button Functions	19
4.3 Back of the Controller	20
4.4 Temperature/Setpoint Display	21
SECTION 5 "RUN MODE"	22
5.1 PID Control Mode	22
5.2 RAMP and SOAK CONTROL 1	22
5.3 RAMP and SOAK CONTROL 2	22
SECTION 6 SETUP AND OPERATION.....	23
6.1 Summary	24
6.2 Security	26
6.3 Setup Control	26
6.4 Model Setup	26
6.5 Setpoints and Alarms	29
6.6 PID setting	31
6.7 Segment control	33
6.8 Ramp and Soak	34
6.9 Set Autotune	35
6.10 Run Autotune	35
6.11 Calibration	36
6.12 Start Profile	37
7.1 Thermocouple Ranges	38
SECTION 8 SPECIFICATIONS	39

SECTION 1 INTRODUCTION

1.1 Description

The CN616 Series is a second generation of industrial temperature controllers based on the field proven CN100 six zone temperature monitor/alarm system. Two models are available, standard and extended range.

The CN616 Series is a microprocessor based temperature controller, which accepts signals from thermocouples. Six zones are sequentially scanned at 15 readings per second [@ 60 Hz] and displayed with a selectable display rate of 1 to 40 seconds each zone. A single output relay is provided to indicate an alarm condition on any one zone. Six PID time proportional or on/off outputs are provided to control six zones. The faceplate has been arranged to call attention to an alarm condition by flashing the main temperature display and indicating the zone in alarm with a flashing zone number display. The CN616 Series implements a security password to protect all functions.

1.2 Features

- Six Zones
- Selectable control mode [PID or On/Off] each zone
- Selectable cooling control mode [On/Off only] each zone
- 20 Segment Profile for each zone
- Selectable number of active zones
- Adjustable Display Time
- Field Proven Zone Switching
- Temperature and Setpoint Monitoring
- Four Digit Display of Temperature
- 1 Digit Display of Zones
- 5 Amp Latching or Non-Latching Relay
- Standard Thermocouples [T,E,J,K,S,R,B,C]
- Extended Ranges [K and E thermocouple types]
- Programmable Selection of HI, LO or HI/LO Alarms
- Password Protection
- 1/4 DIN Aluminum Box
- Splash Proof Face
- Plug-In I/O Terminals
- RS-232 Communication

1.3 Models

Two Models are available:

- CN616TC1 - Standard Range Thermocouple
- CN616TC2 - Extended Range Thermocouple

1.4 Overview of operation

On power up the controller enters one of three run modes determined by model configuration (function [71] 33)

Mode 1	[00]	Standard Control
Mode 2	[51]	Ramp & Soak 1 - end power off
Mode 3	[52]	Ramp & Soak 2 - end run last setpoint

Each zone runs as an independent controller, except for PID parameters, (proportional band, reset and rate) and output cycle time which are common to all zones. In on/off mode hysteresis is common to all zones.

Any zone can be disabled or set to run under PID control or on/off control (heating or cooling) independent of other zones. If all zones are disabled, zone 1 will be enabled by default.

Each zone can be setup to run as a standard control, set independently with function [36], or as a profile of up to 20 segments set by functions [01] to [20].

To run a standard control, set the number of segments (function [74]) for that zone to 0.

To run any zone in PID control mode set the PID zone enable function [43]. To disable any zone use function [31].

Alarms

The CN616 has 4 alarm options set by model select function [33].

0. Overheat Alarm
1. Underheat Alarm
2. Hi - Lo Alarm
3. No Alarm

Overheat or **Hi alarm** is triggered by temperature going over the setpoint beyond boundary set by the hi alarm setpoint. To trigger the

alarm the temperature must stay in alarm condition for a few seconds. This is to prevent a false alarm.

Underheat or **Lo alarm** is disabled until enabled zone reach and stay over the setpoint for a set time. This is to prevent alarm when starting from cold. When **Lo alarm** is enabled it will be triggered only when confirmed over time same as **Hi alarm**.

Hi - Lo works the same as **Overheat** and **Underheat** alarms.

No Alarm disables both **Hi** and **Lo** alarms.

When any zone goes into an alarm condition zone scan lock is disabled, and when the alarm zone is displayed the temperature display will flash.

Hi alarm is indicated by flashing left function digit while **Lo** alarm is indicated by flashing right function digit. In case of latching alarm, **Hi** alarm takes precedence and **Hi** alarm will show even if both alarms are latched.

Note! Whenever the **“Run” Mode** is exited to set or power off all alarms are reset.

Autotune

The PID control constants that are the same for all zones programmed for PID Mode. Autotuning can be done on any one zone selected for the Autotuning. The system parameters are measured during autotuning by supplying full power output to the system until the autotuning setpoint is reached, then the output power is switched Off allowing the temperature to overshoot and then drop down freely back to the autotuning setpoint. Then the power is switched on again until setpoint is crossed. At that point autotuning is completed, the PID constants are calculated and stored in memory until the next autotuning or manual changes are made. For best results the autotuning setpoint should be as close as possible to the control setpoint. However, since the temperature will overshoot the autotuning setpoint during the autotune by the full proportional band, Systems that cannot tolerate that temperature should have autotuning setpoint one proportional band value below the control setpoint.

Setting of the controller can be entered from run mode, by pressing two buttons together, that will request password, function [99], unless password is disabled, then controller will go into function [70], which is the function select.

PID

All zones set for PID use the same PID parameters i.e.:- Proportional band, Reset and Rate. These are derived from autotuning or manual setting. To achieve closest control the slowest zone should be chosen for the autotuning. If control is not optimal manual adjustment may be advisable.

On Off

On-off control is available for zones not set for PID control. All zones under on-off control are subject to the same hysteresis setting.

Profiling

The CN616 allows the process to be controlled under a precise time/temperature profile.

The Profile of each zone can be set within 20 segments.

Each segment consists of 3 parameters



1. Setpoint in °C or °F
2. Slope in °C/ min. or °F/ min.
3. Time in hours

Note ! Slope always takes precedence over the time. That means that if slope is set then time will be ignored. To activate time slope must be set to (0). When slope is set to (0) time is used to calculate the slope for ramp. This way finer slope setting is possible.

Warning! In Soak application slope must be set to (0), otherwise time will be ignored and soak will not occur.

Example of setting Profile Segments

	Segment 1	Segment 2	Segment 3
Setpoint	0 2 0 0	0 2 0 0	0 4 0 0
Slope	0 4.0	0 0.0	0 8.0
Time	0 0. 0 0	0 1. 0 0	0 0. 0 0
	Starting from the current temperature go to 200 deg at 4 deg /minute	Soak at 200 deg for 1 hour	Climb to 400 deg at a rate of 8 deg per minute

To start setting a Profile, the main display shows the setpoint with the first digit (MS) flashing. Set digits with the  button. Then scroll through the display with the  button. After scrolling through 4 digits the display will change to slope. The slope has only 3 digits, after scrolling through slope main display will show 4 digit time, and after time setpoint again. To distinguish between setpoint slope and time setpoint has 4 full digits, slope has 3 digits with decimal point after second digit, and time has 4 digits with a decimal point after second digit. When all parameters are set save data with the  button.

Saving data will advance display to the next segment.

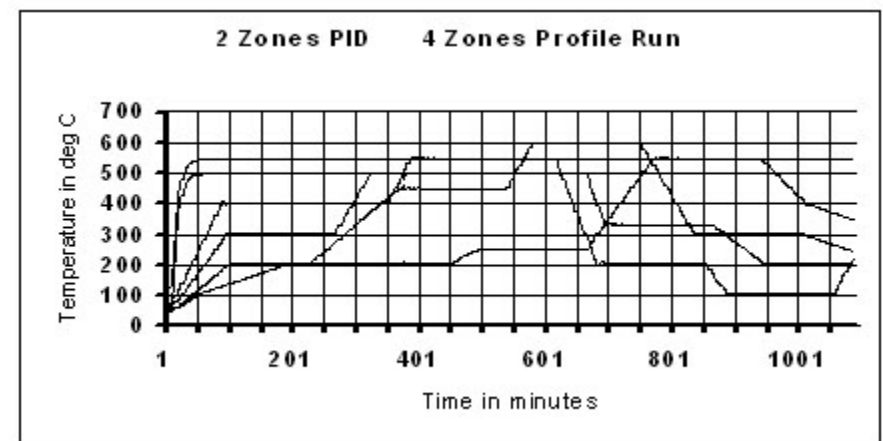
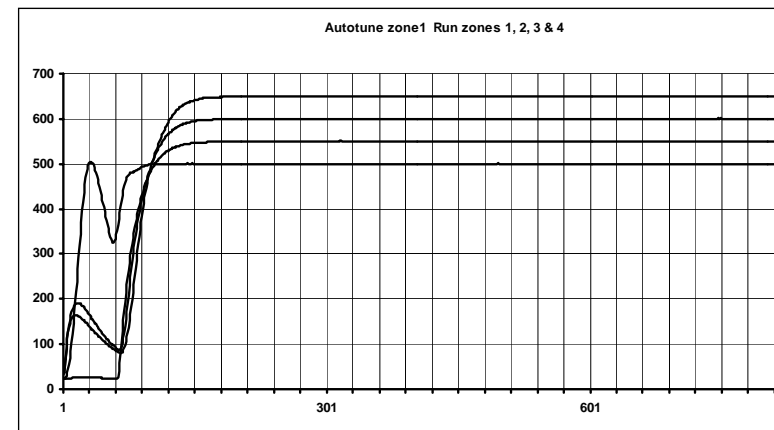

SECTION 2 RS-232 COMMUNICATIONS

NOTE: Minimum requirements to run RS-232 software is a PC computer with Windows 95.

2.1 Description

Up to ten controllers can be connected in parallel to a single RS-232 communications port on a PC. Each controller is assigned a serial number from 0 to 9 known as the RS-232 ID code. The computer uses these numbers to determine which controller unit to address at a given time. Each controller must have a different ID.

A simple set of menus is provided in the software which allows the operator to change the settings of each connected controller unit and display individual operating parameters.

For users with advanced software capabilities, see Section 2.4 for an operating protocol.

2.2 RS-232 Cable Connections

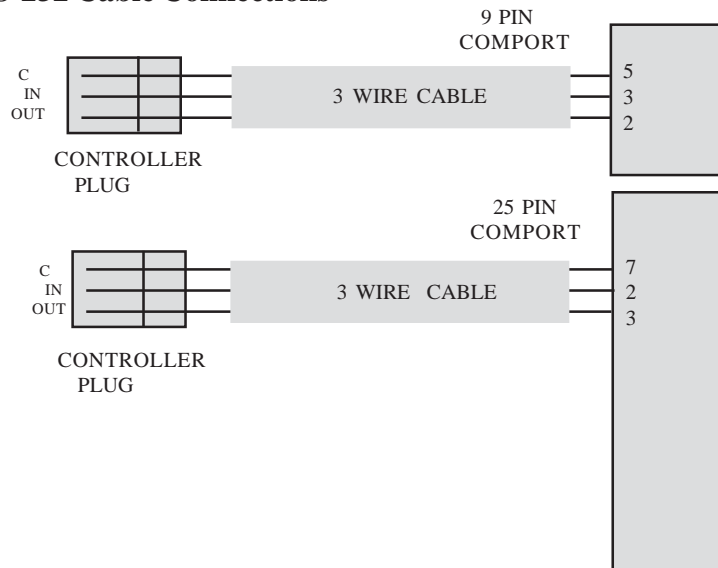

2.3 Operating Protocol for RS-232 Communications

The CN616 Controller is designed with standard RS-232 three wire serial communication capabilities. Up to ten controllers can be parallel connected to a single PC. The transmission line is held in tristate to avoid cross-talk between controllers except when the computer addresses a specific controller for communication.

Configuration

BAUD rate = 4800

Data bits = 8

Parity = N

Stop = 1

Communication software for the PC is written in Visual Basic. This software package has been created to operate on PC Windows 95 platform meeting the minimum requirements.

Customers can communicate with CN616 controllers through a PC by using the following protocol:

- Controllers will not initiate communication. The RS-232 Command Module (computer or similar device) must initiate.
- All communication is in ASCII format
- To start communication, the Command Module must send alert code ASCII [L] hex 4C. This commands the controllers to cease RS-232 communication and listen for an RS-232 ID Code. The Command Module then sends the Identification Number for the controller that it needs to address, ASCII [0 to 9] hex 30 to 39. The identified controller will then expect a command code. All the other controllers on-line will wait for the next alert code.

- Command codes are divided into two groups:

Group 1. Commands “CAPITAL” requesting data from the controller.

Group 2. Commands “small” sending data to the controller.

2.3.1 List of data transfer Codes

Parameters:- Code ‘J’ controller sends string
 Code ‘j’ controller receive string
 Protocol from computer “L3J” request for data
 “L3j” + string of data
 Data string 16 characters long
 zone enable [77]
 password enable [x0]
 model [1204]
 ID [x9]
 scan time [39]
 password [1011]
 zone enable code [0111 0111] binary
 654 321 zones

Setpoints:- Code ‘B’ controller sends string
 Code ‘b’ controller receive string
 Protocol from computer “L3B” request for data
 “L3b” + string of data
 Data string 24 characters long [6 setpoints 4 characters each.]

High alarms:- Code ‘C’ controller sends string
 Code ‘c’ controller receive string
 Protocol from computer “L3C” request for data
 “L3c” + string of data
 Data string 24 characters long [6 high alarms 4 characters each.]

Low alarms:- Code ‘D’ controller sends string
 Code ‘d’ controller receive string
 Protocol from computer “L3D” request for data
 “L3d” + string of data
 Data string 24 characters long [6 low alarms 4 characters each.]

Number of segments:- Code ‘F’ controller sends string
 Code ‘f’ controller receive string
 Protocol from computer “L3F” request for data
 “L3f” + string of data
 Data string 12 characters long. [6 zones 2 characters each](00 to 20)

Segment parameters:- Code ‘U’ controller sends string
 Code ‘u’ controller receive string
 Protocol from computer “L3U” request for data for zone 1
 “L3u” + string of data for zone 1
 Data string 240 characters long. Segment data zone 1
 20 segments 12 characters each segment
 [9999] setpoint 9999 degrees
 [0999] slope 99.9 degrees/minute
 [9999] time 99.99 hours

Segments:- Codes ‘V’ to ‘Z’ same format as code ‘U’
 Code ‘V’ zone 2
 Code ‘W’ zone 3
 Code ‘X’ zone 4
 Code ‘Y’ zone 5
 Code ‘Z’ zone 6

Temperature and alarms:- Code ‘T’ controller sends string
 Protocol from computer “L3T” request for data
 Data string 28 characters long. temperature of 6 zones and alarms
 [9999] temperature zones 1, 2, 3, 4, 5, & 6
 [77] high alarm
 [77] low alarm

Start Profile:- Code ‘p’ controller receive string
 Protocol from computer “L3p” + string of data
 Data string 2 characters long. [zF]
 z = (0 to 6) = zone to profile, (7) = all zones F = filler

Current setpoints:- Code ‘R’ controller sends string
 Protocol from computer “L3R” request for data
 Data string 24 characters long. Setpoints of 6 zones
 [9999] Setpoint zones 1, 2, 3, 4, 5, & 6 (updated by profile)

PID parameters:-

Code	“K”	controller sends string
Code	“k”	controller receive string
Protocol from computer	“L3K”	request for data
	“L3k”	+ string of data

Data string 22 characters long

[9990]	cycle time	99.90 seconds
[99]	hysteresis	99 degrees
[77]	PID zone enable	0111 0111
[9999]	proportional band	9999 degrees
[0999]	reset	9.99
[9999]	rate	99.99
[77]	Cooling zone enable	0111 0111

Set for Autotune:-

Code	“S”	controller sends string
Code	“s”	controller receive string
Protocol from computer	“L3S”	request for data (8 ch)
	“L3s”	+ string of data (6 ch)

Data string send 8 characters long ; receive 6 characters long

[06]	zone for Autotune	[1 to 6]
[9999]	autotune setpoint	
[61]	run mode	[00, 51, 52, 61, “S” send only]

Start Autotune:-

Code	“G”	controller receive command
Protocol from computer	“L3G”	Start command

Stop Autotune:-

Code	“H”	controller receive command
Protocol from computer	“L3H”	Stop command

Notes:-

1. All data sent to the controller must be decimal (ASCII format).
2. All data sent to the controller and code “G & H” are echoed back to the computer.
3. Any non decimal character in the data stream will terminate reception, and data received to that point will be ignored.

11

2.4 RS-232 PC Screens

Six examples of program screens are shown below.

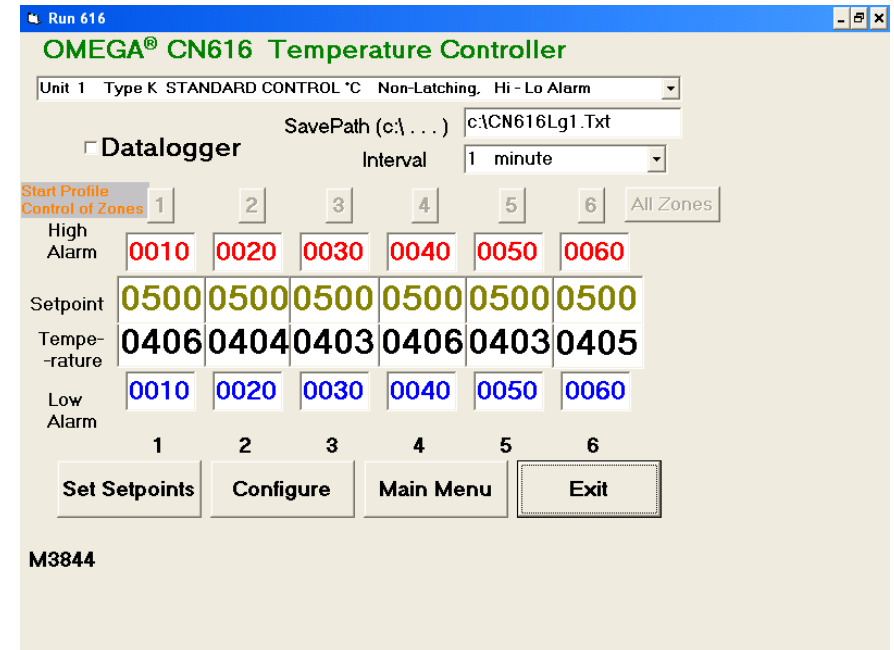

12 To enable Data Logging click on the Datalogger box.

Set Profile
OMEGA® CN616 Controller
Zone 1 Segment 8 Setpoint
 Setpoint 9999 deg.
 Slope 99.9 deg/minute
 Time 99.99 hours

Program Data **EXIT**

	1	2	3	4	5	6	7	8	9	10	11	12	13	14	15	16	17	18	19	20
1	0200	0280	0250	0200	0200	0444	0400	0400	0400	0250	0200	0200	0300	0300	0200	0250	0200	0000	0000	0000
	0180	0000	0000	0500	0000	0180	0000	0180	0000	0180	0000	0180	0000	0180	0000	0180	0000	0000	0000	0000
	0000	0025	0025	0000	0030	0025	0000	0035	0000	0035	0035	0035	0025	0015	0035	0035	0035	0000	0000	0000
2	0320	0320	0420	0250	0200	0444	0300	0400	0400	0250	0200	0200	0300	0300	0200	0250	0200	0000	0000	0000
	0180	0000	0180	0000	0180	0000	0180	0000	0180	0000	0180	0000	0180	0000	0180	0000	0180	0000	0000	0000
	0000	0035	0000	0035	0035	0025	0000	0035	0000	0035	0035	0035	0035	0035	0035	0035	0035	0000	0000	0000
3	0300	0300	0400	0250	0200	0444	0300	0400	0400	0250	0200	0200	0300	0300	0200	0250	0200	0000	0000	0000
	0180	0000	0180	0000	0180	0000	0180	0000	0180	0000	0180	0000	0180	0000	0180	0000	0180	0000	0000	0000
	0000	0035	0000	0035	0035	0025	0000	0035	0000	0035	0035	0035	0035	0035	0035	0035	0035	0000	0000	0000
4	0340	0340	0440	0250	0200	0444	0300	0400	0400	0250	0200	0200	0300	0300	0200	0250	0200	0000	0000	0000
	0180	0000	0180	0000	0180	0000	0180	0000	0180	0000	0180	0000	0180	0000	0180	0000	0180	0000	0000	0000
	0000	0035	0000	0035	0035	0025	0000	0035	0000	0035	0035	0035	0035	0035	0035	0035	0035	0000	0000	0000
5	0350	0350	0400	0250	0200	0444	0300	0400	0400	0250	0200	0200	0300	0300	0200	0250	0200	0000	0000	0000
	0180	0000	0180	0000	0180	0000	0180	0000	0180	0000	0180	0000	0180	0000	0180	0000	0180	0000	0000	0000
	0000	0035	0000	0035	0035	0025	0000	0035	0000	0035	0035	0035	0035	0035	0035	0035	0035	0000	0000	0000
6	0360	0360	0460	0250	0200	0444	0300	0400	0400	0250	0200	0200	0000	0000	0000	0000	0000	0000	0000	0000
	0180	0000	0180	0000	0180	0000	0180	0000	0180	0000	0180	0000	0180	0000	0180	0000	0180	0000	0000	0000
	0000	0035	0000	0035	0035	0025	0000	0035	0000	0035	0035	0035	0000	0000	0000	0000	0000	0000	0000	0000

Autotune 616
OMEGA® CN616 Autotune
 Unit 1 Type K STANDARD CONTROL °C Non-Latching, Hi - Lo Alarm
 SavePath (c:\...) c:\Autotune1.Txt
 Datalogger Interval 1 minute
 Set Autotune Zone 3
 Set Autotune Setpoint 0350
 Temperature 0403
 Run Autotune Main Menu Exit
 M3844

Configure Unit
OMEGA® CN616 Model Configuration
 MSD Degrees C/F Control Mode Profile Segments ZONES
 Overheat Alarm Latching Relay °C
 Underheat Alarm Latching Relay °F
 Hi - Lo Alarm Non Latching Relay °C
 No Alarm Non Latching Relay °F
 STANDARD CONTROL
 RAMP AND SOAK 1
 RAMP AND SOAK 2
 Unit 1 Type K STANDARD CONTROL °C Non-Latching, Hi - Lo Alarm
 Thermocouple LOAD CHANGE RETURN/RUN MAIN SET SETPOINTS NEW PASSWORD SET PROFILE
 Type B Type K
 Type R Type C
 Type E Type S
 Type J Type T
 PID Setup Cycle time (output) 04.0 sec.
 Hysteresis (on/off deviation from SP) 01 deg. C/F
 PID zone enable 1 2 3 4 5 6
 Cooling zone enable
 Proportional band 0200 deg. C/F
 Reset 0.00 Repeat/min.
 Rate 00.00 min.
 M3844

Set Setpoints
OMEGA® CN616 Temperature Controller SETUP
 Unit 1 Type K STANDARD CONTROL °C Non-Latching, Hi - Lo Alarm
 Enable Zone 1 2 3 4 5 6
 High Alarm 0010 0020 0030 0040 0050 0060
 Setpoint 0500 0500 0500 0500 0500 0500
 Temperature 0406 0404 0403 0406 0403 0405
 Low Alarm 0010 0020 0030 0040 0050 0060
 Load Change Main Menu Return/Run
 Set Profile Configure SCAN SPEED 4
 M3844

SECTION 3 INSTALLATION

3.1 Unpacking

Upon receipt of shipment, inspect the container and equipment for any signs of damage. Take particular note of any evidence of rough handling in transit. Immediately report any damage to the shipping agent.

Remove the packing list and verify that all equipment has been received. Each package should contain:

- Controller (CN616)
- Operator's Manual
- RS-232 Software
- Two mounting slides with screws
- Power plug (9 pin)
- RS-232 plug (3 pin)
- Two T/C plugs (6 pin)
- Two Output plugs (6 pin)

If there are any questions about the shipment, please call the Customer Service Department.

NOTE: The carrier will not honor any claims unless all shipping material is saved for their examination. After examining and removing contents, save packing material and carton in the event reshipment is necessary.

3.2 Mounting

Select a location for the controller that is free from excessive shock, vibration, dirt, moisture and oil. Mount the controller into a 3 5/8" (92mm) square cutout. The controller as shipped is 1/4 DIN (92mm square), so it does not have to be removed from it's housing to be mounted.

Remove the two screws that secure the mounting slides. Remove the slides and insert the case into the cutout from the front side of the panel. Reinstall the two slides and two screws. The length of the slides must be reduced if the controller is to be mounted in an extra thick panel.

3.3 Outline Dimensions

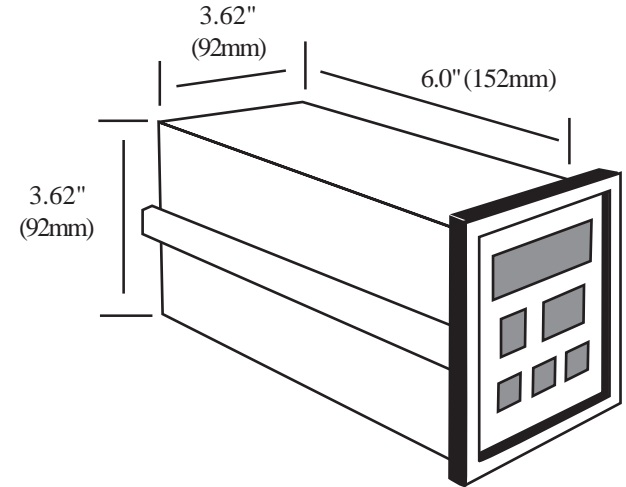

3.4 Wiring the Power Circuit

The line voltage for the controller is selected by an external jumper assembly to operate either on 120VAC or 240VAC \pm 10%, 50/60Hz (factory wired for 120VAC). It is very important that the proper line voltage is connected to the instrument. If 120VAC is connected to a 240VAC model, it will not work properly. A 120VAC instrument connected to 240VAC will overheat and burn the input transformer.

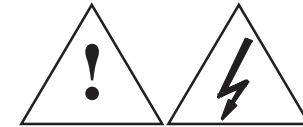

WARNING! !

The controller is powered with either 120 or 240 VAC. To avoid electric shock or fatality hazards the power to the controller lines must be switched off at the main switch, or circuit breaker before the controller A/C wiring, including the line selector jumpers can be handled.

3.5 Changing Line Voltage Setting

Program the input line voltage by placing jumpers on the line plug as shown:

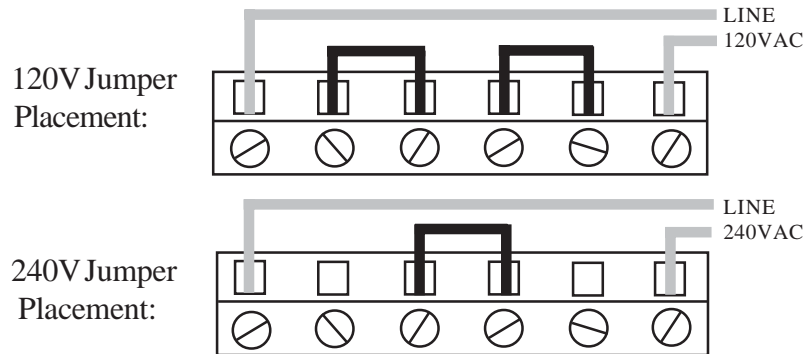

WARNING! !
Line Voltage
see Pg 16

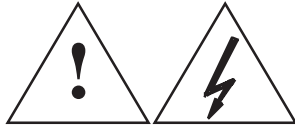

3.6 Sensor Placement

Proper sensor placement is essential. It can eliminate many problems in the total system. The probe should be placed so that it can detect any temperature change with little thermal lag. In a process that requires fairly constant heat output, the probe should be placed close to the heater. In processes where the heat demand is variable, the probe should be close to the work area. Experimenting with probe location can often provide optimum results. Some units are shock sensitive and require care in handling and installation. To avoid current feedback from zone to zone and from zone to RS-232 communications, ungrounded thermocouples are recommended. Thermocouple wires should not be placed in the same conduit as the power lines.

SECTION 4 PARTS OF THE INSTRUMENT

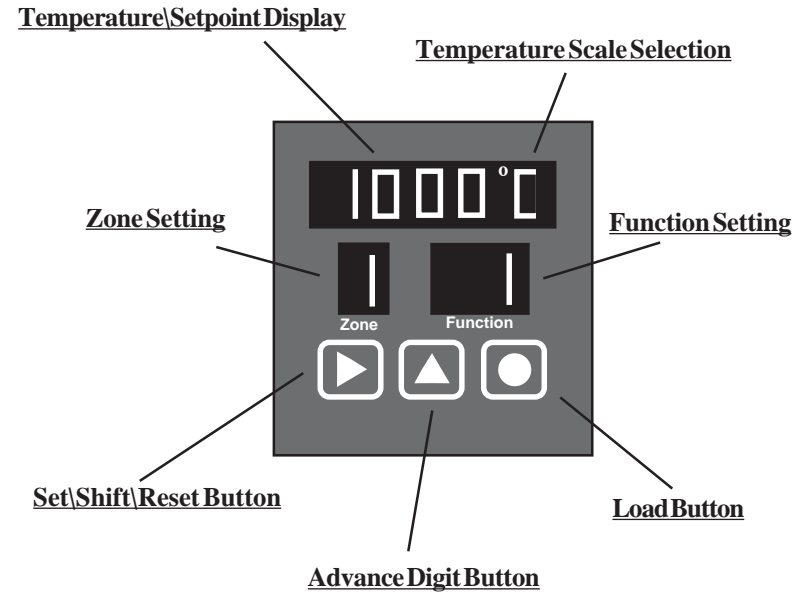

Temperature/Setpoint Display- Main display with multiple functions.

Temperature Scale Selection- Choice of °C or °F.

Function Setting- Indicates the operating status of the instrument.

Zone Setting- Indicates an active zone or a zone that is being set.

Set/Shift/Reset Button- Used to select digits during setup or to unlock the display scan.

Advance Digit Button- Used to increment selected digit.

Load Button- Used to accept a setting or to lock display zone.

4.2 Button Functions

There are three flatpad buttons provided and two combinations of buttons for separate functions.

Shift Button



1. Selects Digit
2. Unlock Zones scan
3. Switches Main Display Functions

Advance Digit Button



1. Advances flashing Digits
2. Advances Zones

Load Button



1. Lock zone scan during **"RUN MODE"**

Note! Zone scan is unlocked by the shift button,  or by an alarm condition. In alarm state zone scan can not be locked.

2. Load set parameters into the memory in **"SET MODE"**

Shift Button & Load Button (together)



1. Enter **"FUNCTION SELECT" MODE**
2. Exits **"FUNCTION SELECT" MODE**
3. Resets Alarm during **"RUN MODE"**

4.3 Back of the Controller

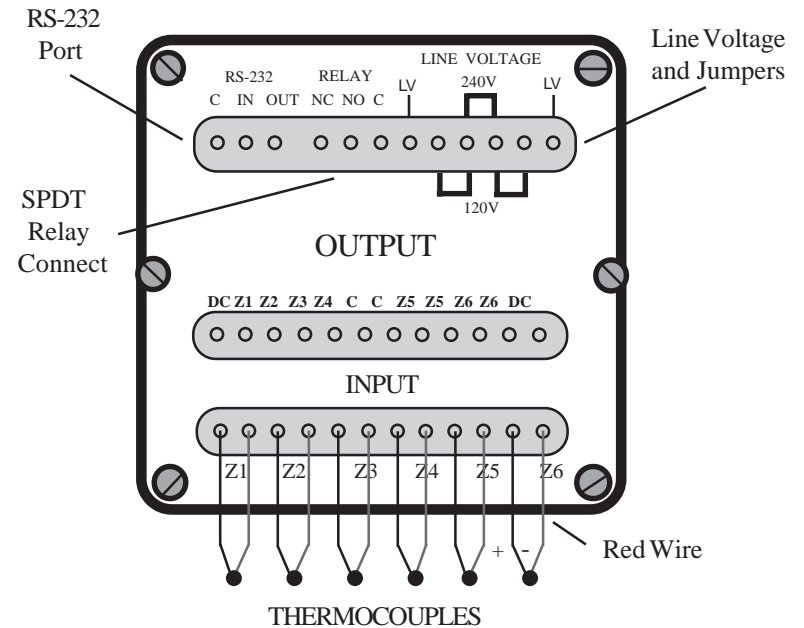

WARNING!!
Line Voltage
see Pg 16



RS-232 Port- Cable connection (see Section 1.3)

C - Common Pin 5
IN - Input Pin 3
OUT - Output Pin 2 } 9 Pin Comport

Relay

NC- Non-energized Closed
NO- Non-energized Open
C- Common

Line

LV- 120VAC or 240VAC cable

Jumpers- Determines voltage input (see Section 3.4)

4.4 Temperature/Setpoint Display (Main Display)

During "RUN" MODE, the Main Display is used to monitor zone temperatures, check setpoints, and indicate ALARM conditions.

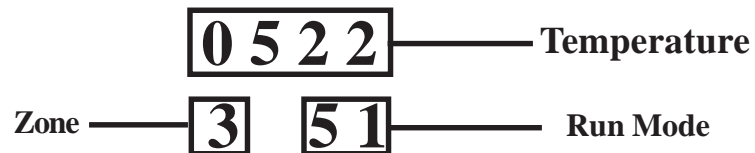

By pressing and holding button The display will change to

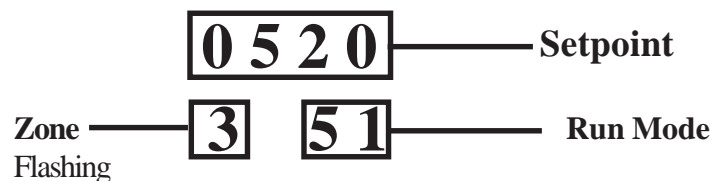

During operator programming in "FUNCTIONSELECT" MODE, the Main Display is used to:

1. Set the Zone Setpoints
2. Enter Passwords
3. Select Functions
4. Set the Zone Display Time
5. Select the Instrument Model
6. Select Run parameters

During CALIBRATION (Function 78), the Main Display is used to:

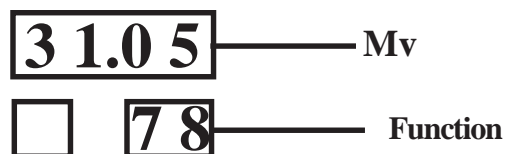

1. Set calibration millivolts

SECTION 5 "RUN" MODE

In the "RUN" Mode, the CN616 controls the temperature under the program established during the last "SET" Mode. The "RUN" Mode is entered every time the controller is powered, after a power interruption, or it can be entered manually from the "SET" Mode, by pushing buttons and together "SET" Mode TIME OUT. If the instrument is left unattended for over 2 minutes in the "SET" Mode, the program will switch it back to "RUN" Mode.

Three "RUN" Modes are available

1. [00] Standard Control FN 33 Control Mode (digit 3) = 0
2. [51] RAMP & SOAK 1 FN 33 Control Mode (digit 3) = 1
3. [52] RAMP & SOAK 2 FN 33 Control Mode (digit 3) = 2

5.1 PID CONTROL MODE

Each one of the six zones is treated as a separate controller and it can run under any one of the following Modes

1. PID enable FN 43
2. Proportional Band (PB) FN 44 - FN 45 & 46 set to 0
3. Proportional Band and Reset (PI) FN 44 & 45 - FN 46 set to 0
4. Proportional Band and Rate (PD) FN 44 & 46 - FN 45 set to 0
5. Proportional Band Reset and Rate (PID) FN 44, 45 & 46
6. Disabled (OFF) FN 31

NOTE!! The PID setting is common to all zones i.e.:- it can not be changed from zone to zone.

The zones can be mixed and set to either PID or ON-OFF FN [43]

5.2 RAMP & SOAK CONTROL 1

In this Mode each zone will follow the RAMP & SOAK program set in Section 6: FN 74 & 75. At the end of the Profile "RUN" the output power will be switched OFF.

5.3 RAMP AND SOAK CONTROL 2

This Mode is exactly the same as RAMP & SOAK 1 except that at the end of the Profile "RUN" the controller will control the temperature at the setpoint of the last segment indefinitely.

NOTE!!

To run Ramp & Soak

Unit must be set to run mode 51 or 52. [Fn 33]

Number of segments must be more than 0 [Fn 74]

Any zone set to # segments = 0 will run in STANDARD mode.

Until PROFILE is started [Fn 79] zone will run in STANDARD mode.



Function 79 will start Profile for any single zone or all zones at once.

First segment will start control from ambient temperature setpoint and take it to the first segment setpoint at the set rate.

At any time PROFILE can be started again, it will go to the start of the first segment



SECTION 6 SETUP AND OPERATION

This section deals with setting up all of the parameters of the CN616 Temperature Controller. FN [70] is assigned for that task. The setup operation is protected by a security password to prevent accidental or unauthorized modifications.

On power up the CN616 controller will enter “RUN” Mode. To enter setup mode press buttons  and  together for few seconds until function [99] or [70] is displayed in the function display.

If password protection is enabled function [99] will request a password. Entry of a four digit password is required to enter function select mode FN [70].

The password is set at the factory to “1011”. The password can only be changed by the software or at the factory.

To enter the password use the button  to increment each digit, use the button  to move to the next digit and  the button to enter the password. Entering a wrong password will return the controller to the “RUN” Mode.

NOTE!!

To avoid inadvertent changes to control settings access to every function must be confirmed by reentering function number.

6.1 Summary

Controller setting is organized in 8 major functions and function groups [71 to 78] and their related functions, listed below.

Function 71 Model Setup Group

function 31	zone enable
function 32	password enable
function 33	model select
function 34	ID for RS-232
function 35	zone display time

Function 72 Control Setup Group

function 36	setpoint
function 37	high alarm (over setpoint)
function 38	low alarm (under setpoint)

Function 73 PID Setup Group

function 41	cycle time (output)
function 42	hystereses (on/off deviation from SP)
function 43	set PID zone
function 44	proportional band
function 45	reset
function 46	rate
function 47	set COOLING zone

Function 74

number of segments for each zone

Function 75	set segments
function 01	segment 01 zone 1 to 6
to function 20	segment 20 zone 1 to 6

Function 76

set setpoint and zone for autotune

Function 77

autotune

function 61	autotune stage 1
function 62	autotune stage 2
function 63	autotune stage 3

















Function 78

calibrate





Function 79

Start Profile





EXAMPLE: Set High Alarm Setpoint [over setpoint]



Action	Buttons to use	Display Before	Display After											
Enter Setup mode	  together	<table border="1"><tr><td>0</td><td>4</td><td>0</td><td>3</td></tr></table> => <table border="1"><tr><td>7</td><td>1</td></tr></table>	0	4	0	3	7	1	<table border="1"><tr><td>7</td><td>0</td></tr></table>	7	0			
0	4	0	3											
7	1													
7	0													
Select Function Group		<table border="1"><tr><td>7</td><td>1</td></tr></table> => <table border="1"><tr><td>7</td><td>2</td></tr></table>	7	1	7	2	<table border="1"><tr><td>7</td><td>0</td></tr></table>	7	0					
7	1													
7	2													
7	0													
Enter Function Group		<table border="1"><tr><td>7</td><td>2</td></tr></table> => <table border="1"><tr><td>7</td><td>0</td></tr></table>	7	2	7	0	<table border="1"><tr><td>7</td><td>2</td></tr></table>	7	2					
7	2													
7	0													
7	2													
Confirm Selection		<table border="1"><tr><td>7</td><td>0</td></tr></table> => <table border="1"><tr><td>7</td><td>2</td></tr></table>	7	0	7	2								
7	0													
7	2													
Enter		<table border="1"><tr><td>7</td><td>2</td></tr></table> => <table border="1"><tr><td>3</td><td>6</td></tr></table>	7	2	3	6	<table border="1"><tr><td>7</td><td>2</td></tr></table>	7	2					
7	2													
3	6													
7	2													
Select SubFunction		<table border="1"><tr><td>3</td><td>6</td></tr></table> => <table border="1"><tr><td>3</td><td>7</td></tr></table>	3	6	3	7	<table border="1"><tr><td>7</td><td>2</td></tr></table>	7	2					
3	6													
3	7													
7	2													
Enter		<table border="1"><tr><td>3</td><td>7</td></tr></table> => <table border="1"><tr><td>0</td><td>0</td><td>0</td><td>0</td></tr></table>	3	7	0	0	0	0	<table border="1"><tr><td>7</td><td>2</td></tr></table>	7	2			
3	7													
0	0	0	0											
7	2													
[repeat for each zone] Set Values	  one button at a time	<table border="1"><tr><td>0</td><td>0</td><td>0</td><td>0</td></tr></table> => <table border="1"><tr><td>0</td><td>0</td><td>1</td><td>5</td></tr></table>	0	0	0	0	0	0	1	5	<table border="1"><tr><td>1</td><td>3</td><td>7</td></tr></table>	1	3	7
0	0	0	0											
0	0	1	5											
1	3	7												
Enter and go to next Zone		<table border="1"><tr><td>0</td><td>0</td><td>1</td><td>5</td></tr></table> => <table border="1"><tr><td>0</td><td>0</td><td>2</td><td>0</td></tr></table>	0	0	1	5	0	0	2	0	<table border="1"><tr><td>1</td><td>3</td><td>7</td></tr></table>	1	3	7
0	0	1	5											
0	0	2	0											
1	3	7												
EXIT setpoints	  together	<table border="1"><tr><td>0</td><td>0</td><td>2</td><td>0</td></tr></table> => <table border="1"><tr><td>3</td><td>6</td></tr></table>	0	0	2	0	3	6	<table border="1"><tr><td>2</td><td>3</td><td>7</td></tr></table>	2	3	7		
0	0	2	0											
3	6													
2	3	7												
EXIT SubFunction	  together	<table border="1"><tr><td>3</td><td>6</td></tr></table> => <table border="1"><tr><td>7</td><td>1</td></tr></table>	3	6	7	1	<table border="1"><tr><td>7</td><td>2</td></tr></table>	7	2					
3	6													
7	1													
7	2													
EXIT Function	  together	<table border="1"><tr><td>7</td><td>1</td></tr></table> => <table border="1"><tr><td>0</td><td>4</td><td>0</td><td>3</td></tr></table>	7	1	0	4	0	3	<table border="1"><tr><td>1</td><td>0</td><td>0</td></tr></table>	1	0	0		
7	1													
0	4	0	3											
1	0	0												

6.2 Function [99] Security

Security password protects all setup functions from accidental or unauthorized modifications. The security password is factory preset At 1011 and it can be changed only under RS232 computer program. The security can be enabled or disabled within Function [71] Model Setup. Whenever FN [99] appears, in function window, it means that the security is enabled and password must be entered one digit at a time. Using button  enter the correct number in the flashing digit, then using button  shift to the next digit and again using button  enter the correct number. Repeat for all four digits, then enter with  button. If password is correct the FN [70] will appear in function window. If not correct the controller will return to the "RUN" Mode. If the process times out the display will return "RUN" Mode.





6.3 Function [70] Function Set up Control

Function [70] is entered from function [99] or directly from "RUN" Mode if password security is disabled. In function [70], the number 70 is displayed in the function window, Increment the flashing digit with the button  until required function shows in the upper display, function [71] to function [78] then enter the selected function with the button  that will display entered function in function window and 70 in the top display. To confirm the function selection increment the flashing digit with the button  until the upper display matches the function display. At this point enter confirmation of the selection with the button . If the process times out the display will return "RUN" Mode. If the two displays do not match, the controller will return to function [70].

To return to RUN mode press two buttons  and  together for a few seconds.

6.4 Function Group [71] Model Setup

Function [71] controls functions [31] to [35]. On entering function [71] the function display shows 71. The upper display shows 31. To select functions

[32]-[35] increment the flashing digit with the button  When the desired function is displayed enter it with the button  This will display the desired function in the function display.
 If the process times out the display will return "RUN" Mode.
 To return to function [70] press two buttons  and  together for a few seconds.

6.4.1 Function [31] zone enable

The zone enable function is used to enable/disable any or all of the zones individually. If all of the zones are disabled then zone one will remain enabled by default

In function [31] the function display will show 31, the zone display will show 1, and the upper display will be blank.

If the zone display is flashing it indicates that the current zone is disabled.

To toggle between enable and disable use the button 

To advance to next zone use the button 

To save the settings and return to function [71] use the button 

6.4.2 Function [32] password enable

The password enable function turns on/off the password protection for changing the settings for the unit. In function [32] the function display will show 32, the zone display will be blank, and the upper display will flash 0 or 1.

If the display is 0 it indicates that the password is disabled.



If the display is 1 it indicates that the password is enabled.

To toggle between enable and disable use the button 

To save setting and return to function [71] use the button 

6.4.3 Function [33] select model

The select model function sets the type of unit for alarms, relay, degrees C or F, control mode, and thermocouple as per the table. In function [33] the function display will show 33, the zone display will be blank, and the upper display will show a 4 digit model code, digit 1 will be flashing.

To increment the flashing digit use the button  To advance to the next digit use the button  To save the settings and return to function [71] use the button 

Four digit model code

Digit 1 0 = Overheat Alarm
 Alarm 1 = Underheat Alarm
 Type 2 = HI-LO Alarm
 3 = No Alarm

Digit 2 0 = Latching Rel. °C
 Relay 1 = Latching Rel. °F
 And °C or °F 2 = Non Latching °C
 3 = Non Latching °F

Digit 3 0 = STANDARD CONTROL
 CONTROL 1 = RAMP AND SOAK 1
 MODE 2 = RAMP AND SOAK 2



Digit 4 0 = TYPE B
 T/C TYPE 1 = TYPE C
 2 = TYPE E
 3 = TYPE J
 4 = TYPE K
 5 = TYPE R
 6 = TYPE S
 7 = TYPE T

Example:

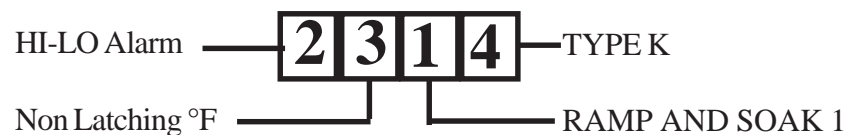
To select "RAMP AND SOAK 1" With type 'K' thermocouple °F with Non Latching HI-LO Alarm, set MODEL as shown below.





6.4.4 Function [34] ID for RS232

The ID code for the RS-232 is the identifying number for each unit connected through an RS-232 line to a computer. If two or more units are connected to a computer every unit must be set to have a different RS-232 ID code for proper operation. In function [34] the function display will show 34, the zone display will be blank, and the upper display will display the 1 digit RS-232 ID code. To increment the flashing digit use the button  To save the settings and return to function [71] use the button 

6.4.5 Function [35] zone display time



The zone display time function sets the time period that each temperature will display in the temperature window. The zone display is settable to 1-40 seconds.

In function [35] the function display will show 35, the zone display will be blank, and the upper display will show the two digit zone display time.



To increment the flashing digit use the button  To advance to the next digit use the button  To save the settings and exit to function [71] use the button 

6.5 Function Group [72] Setpoints and Alarms

Function [72] controls functions [36] to [38]

On entering function [72] the function display shows 72. The upper display reads 36. To select functions [36] to [38] increment the flashing digit with the button  When the desired function is displayed enter it with the button  This will display set function in function display.

If the process times out the display will return "RUN" Mode.

To return to function [70] press two buttons  and  together for a few seconds.

6.5.1 Function [36] setpoint

The setpoint function allows setting the control point of the temperature controller for each zone. This setpoint is for STANDARD CONTROL only. Ramp and Soak setpoints are set in function 75, or computer.

In function [36] the function display will show 36, the zone display will show 1, and the upper display will show the current setpoint.

To increment the flashing digit of the setpoint use the button 

To advance to the next digit use the button 

To save the settings and go to the next zone use the button 

To exit to function [72] use the buttons  and  together for a few seconds.

6.5.2 Function [37] high alarm (over setpoint)

The high alarm function sets the high temperature safety point for each zone above which each zone will go into alarm mode.

In function [37] the function display will show 37, the zone display will show 1, and the upper display will show the two digit current alarm setting.

To increment the flashing digit of the setpoint use the button 

To advance to the next digit use the button 

To save the setting and go to the next zone use the button 

To exit to function [72] use the buttons  and  together for a few seconds.

6.5.3 Function [38] low alarm (under setpoint)

The low alarm function sets the low temperature safety point for each zone below which each zone will go into alarm mode. To prevent alarming on low temperature during start-up the low alarm is disabled until the zone exceed it's setpoint for a set period of time.

In function [38] the function display will show 38, the zone display will show 1, and the upper display will show the two digit current alarm.

To increment the flashing digit use the button 



To advance to the next digit use the button 

To save the setting and go to the next zone use the button 



To exit to function [72] use the buttons  and  together for a few seconds.

6.6 Function Group [73] PID Setup

The functions in group 73 allow the operator to examine and or change the PID constants including those generated by autotuning. Function [73] controls functions [41] to [46]

On entering function [73] function display shows 73. The upper display shows 41. To select the desired function [41] to [46] increment the flashing digit with the button  When the desired function is displayed enter it with the button  This will display the selected function in the function display.

If the process times out the display will return "RUN" Mode.

To return to function [70] press two buttons  and  together for a few seconds.

6.6.1 Function[41] Output cycle time (99.9) sec...

This function allows the operator to examine and change the Output cycle time

In function [41] the function display will show 41, the zone display will be blank, and the upper display will show the three digit current Output cycle time setting.

To increment the flashing digit press the button 

To advance to the next digit press the button 

To save setting and exit to function [73] press the button 

6.6.2 Function[42] Hysteresis on-off control (99) deg C or F

In the on-off control with hysteresis function the operator can control the dead band in which the output does not change. In function [42] the function display will show 42, the zone display will be blank, and the upper display will show the two digit current Hysteresis.

To increment the flashing digit press the button 

To advance to the next digit press the button 

To save setting and exit to function [73] press the button 

6.6.3 Function[43] enable PID zone

The enable PID zone Function allows selection of on/off or PID control for individual zones. In function [43] the function display will show 43, the zone display will show 1, and the upper display will be blank.

If the zone display is flashing it indicates that the zone is selected for on-off control. If the zone display is not flashing then it is selected for PID control.

To toggle between enable and disable use the button 

To advance to the next zone use the button 

To save the settings and return to function [73] use the button 

6.6.4 Function[44] Proportional Band (9999) deg C or F

The proportional band function allows the user to examine and set the proportional band.

In function [44] the function display will show 44, the zone display will be blank, and the upper display will show the current Proportional band.

To increment the flashing digit use the button 

To advance to the next digit use the button 

To save the settings and exit to function [73] use the button 

6.6.5 Function[45] Reset (9.99) repeats / min.

The reset function allows the operator to examine and change the integral function of PID control.

In function [45] the function display will show 45, the zone display will be blank, and the upper display will show the three digit current Reset setting.

To increment the flashing digit use the button 

To advance to the next digit use the button 

To exit to function [73] use the button 

6.6.6 Function [46]

Rate (99.99) minutes

The Rate function allows the operator to examine and change the differential function of PID control.

In function [46] function display will show 46, the zone display will be blank, and the upper display will show the current Rate.

To increment the flashing digit press the button 

To advance to the next digit press the button 

To save setting and exit to function [73] press the button 

6.6.7 Function [47]

enable Cooling zone

This function is set in the same manner as function [43].

Zones enabled by this function will run in on/off control mode and will have outputs inverted to control cooling.

6.7 Function [74] Segment Control (set number of Profile Segments for each zone)

The segments function allows the operator to set the size of the profile in segments and the number of profile variants. Function [74] does not control any other function

On entering function [74] function display shows 74.

Zone display shows zone 1.

The first and second digits in the upper display shows the current number of segments for the displayed zone.

To increment the flashing digit press the button 

To advance to the next digit press the button 

To save the settings and go to the next zone press the button 

To exit to function [70] use the buttons  and  together for a few seconds.

Note !! The number of segments is restricted to 20 for each zone.

Setting 0 segments will force the controller to run that zone in a STANDARD Mode using setpoint set by function [36]. This allows a mix of zones running STANDARD Mode and PROFILE

6.8 Function Group [75] Ramp and Soak

Function [75] controls segment functions [01] to [20]

On entering function [75] the function display shows 75. The upper display will read 01 . The zone window will show 1.



To select the segment and zone to be set, enter the segment number and zone. Note that the segment number is restricted by the number of segments set in function [74].

To increment the flashing digit press the button 

To advance to the next digit (segment and zone number) press the button 

To enter the segment to be set press the button 

On entering segment display will advance to the next segment. If the last segment of that zone is entered then display will advance to the first segment of next zone.

To return to function [70] press two buttons  and  together for a few seconds.

6.8.1 Function [01]

Set Segment 1

Setpoint (9999) degrees

Slope (99.9) deg / minute

Time (99.99) hours

In function [01] the function display will show 01.



The zone display will show the selected zone.

The upper display will show the 4 digit current Setpoint. To accommodate 3 parameters the upper display will scroll through 3 independent displays. To recognize which display is shown each parameter has a different look. The setpoint parameter displays 4 digits. The slope parameter is displayed with three digits. The time parameter is displayed with 2 digits followed by 2 decimal digits.

To increment the flashing digit press the button 

To advance to the next digit and scroll press the button 

To save the segment and advance to the next segment press the button 

To return to function [75] press two buttons  and  together for a few seconds.

Note !! Only the number of segments set in function [74] are allowed to be set. After last segment is saved the unit segment setup will advance to the next zone. This way all segments are set in sequence. Out of sequence segments can be set by returning to function [75] after saving each segment.

6.8.2-20 Function[02] to [20] Set Segment 02 to 20 follow the same procedure as Function [01]

6.9 Function [76] Set Autotune

Function [76] does not control any other function

On entering function [76] the function display shows 76.

The zone display shows zone 1.

The upper display shows the current Autotune setpoint.

By advancing the flashing digit the operator can scroll through the top display and the zone display and set the Autotune setpoint & zone.

To increment the flashing digit press the button 

To advance to the next digit with press the button 

To save the settings and return to function [70] press the button 

6.10 Function [77] Run Autotune

The PID control constants that are the same for all zones programmed for PID Mode. Autotuning can be done on any one zone selected for the Autotuning. The system parameters are measured during autotuning by supplying full power output to the system until the autotuning setpoint is reached, then the output power is switched OFF allowing the temperature to overshoot and then drop down freely back to the autotuning setpoint. The power is switched ON again, the temperature will fall below the setpoint and rise up to the setpoint. At that point autotuning is completed, the PID constants are calculated and stored in memory until the next autotuning or manual changes are made. For best results the autotuning setpoint should be as close as possible to the control setpoint. However, since the temperature will overshoot the autotuning setpoint during the autotune by the full proportional band, Systems that cannot tolerate that temperature should have autotuning setpoint one proportional band value below the control setpoint.



Function [77] initiates unit autotuning.

On entering function [77] the function display reads 61.

The zone display shows the zone set for autotuning.

The upper display shows current temperature. When the top display and function display are flashing the power is turned on.

When temperature reaches the Autotune setpoint the power goes off and the function display shows 62. On completion of the autotuning the controller returns to “RUN” Mode.

To stop the autotune press two buttons  and  together

6.11 Function [78] Calibration

Calibration is performed by inputting DC MV from a low Impedance source (10Ohm) and entering the precise value of the MV into the display.

UNIT WIRING:

Using copper wire, connect the positive and negative terminals of the Input Connector to a precision millivolt meter and a low output impedance source (10 ohm or less) set to 30mV ±2mV input.

Parallel-connect all thermocouple terminals of the Input Connector as shown:

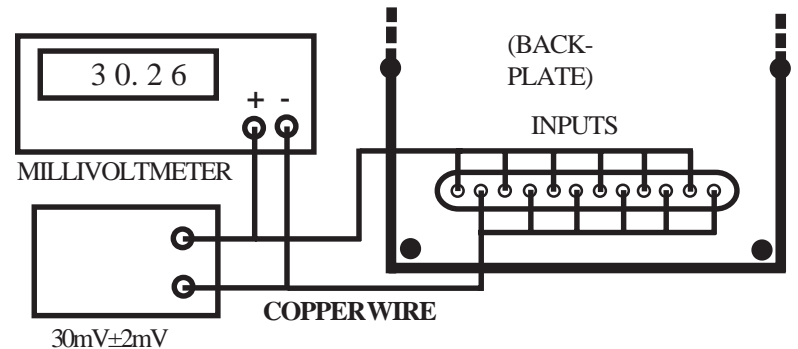



NOTE: To avoid any interference during calibration, disconnect the RS-232 wires from the controller.

On entering function [78] the function display will read 78.
 The upper display shows 30.00 mV setting.
 Enter the exact mV as measured by the millivolt meter.
 The main display will flash all zero's. During this period the controller is checking calibration so do not alter the mV reading. When the flashing stops, the calibration is complete and the controller will return to "RUN" Mode.

To increment the flashing digit press the button 
 To advance to the next digit press the button 
 To save the mV setting and start calibration press the button 

6.12 Function [79] Start Profile

Function [79] does not control any other function
 On entering function [79] the function display shows 79.
 The zone display shows blank.
 The upper display shows 0.
 By advancing the flashing digit the operator can select
 [0] to return with no changes
 [1] to [6] to start profile on any one zone 1 to 6
 [7] to start profiles on all enabled zones 1 to 6
 To increment the flashing digit press the button 
 To start profile and return to "RUN" mode press the button 

Open Collector Transistor Diagram for Output

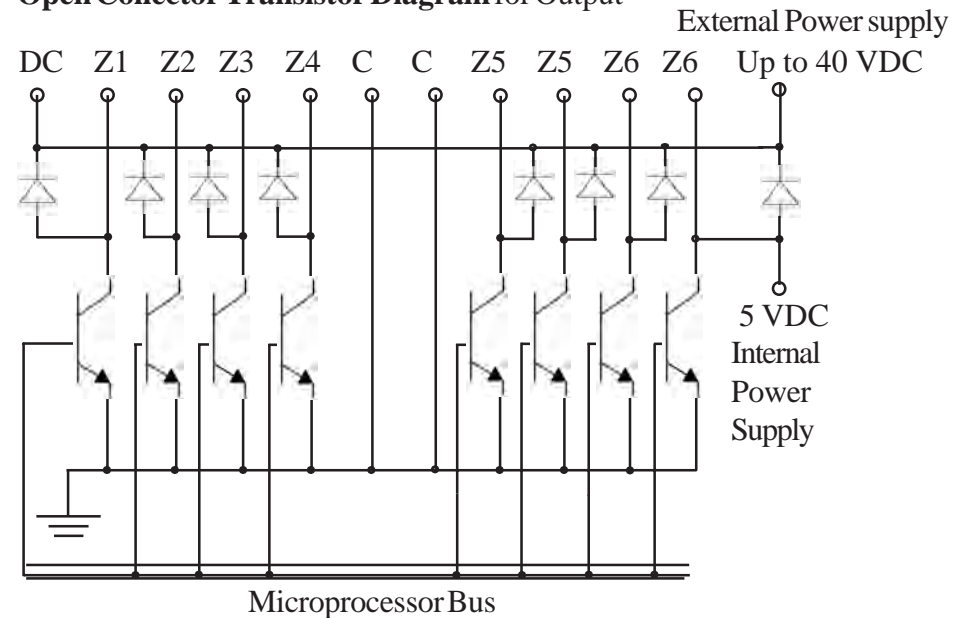

Note ! See page 40 for Wiring Diagram of controller outputs

7.1 Thermocouple Ranges

TC	Standard Ranges [40 Mv]	
	°C Range	°F Range
B	0-1800	32-3300
C	0-2300	32-4200
E	0-500	32-1000
J	0-750	32-1400
K	0-1000	32-1900
R	0-1750	32-3200
S	0-1750	32-3200
T	0-400	32-750
	Extended Ranges [75 Mv]	
E	0-1000	32-1800
K	0-1300	32-2500

Note ! Extended range will work with all Standard range thermocouples, but it is better to use Standard range for thermocouples with output below 40 Mv.

SECTION 8 SPECIFICATIONS

No. of Zones	Six
Input Range	0-40mV Standard/ 0-75mV Expanded
Accuracy	±0.2% Range, ±2°C
Resolution	±5uV
Thermocouple Input selectable	B,C,E,J,K,R,S,T
Scale Selectable	°C or °F
PID	Autotune or Manual
Password protection	Yes
Profiling [ramp/soak]	20 segments per loop
Control outputs	6 [one per loop]
Output rating :- Internal power	5V DC 10 Ma max
External power	5 to 40V DC 0.5 Amp
Communication	RS-232
Communication Software	Visual Basic [Windows]
Zone display time	Settable 1 to 40 sec or Hold on any zone
Alarms Selectable	HI - LO - HI/LO or no alarms
Alarm Type	Latching or Non Latching
Alarm display	Flashing display [zone in alarm]
Alarm output [deenergises on alarm]	Single relay for all zones
Alarm Reset	Manual
Relay rating	5 Amp @ 120 VAC
Display	LED 0.6" high
Enclosure	1/4 Din Aluminum, 6" long
Terminals	Headers for Plug-in Wiring
Line Power	120/240VAC; 50/60Hz
Power Consumption	10VA Max.
Max. Voltage between Inputs	6VDC or RMS
Open T/C Warning	Flashing Display [9999]

WIRING OF THE CONTROLLER OUTPUT

1. USING INTERNAL 5V SUPPLY 5MA/ZONE MAX

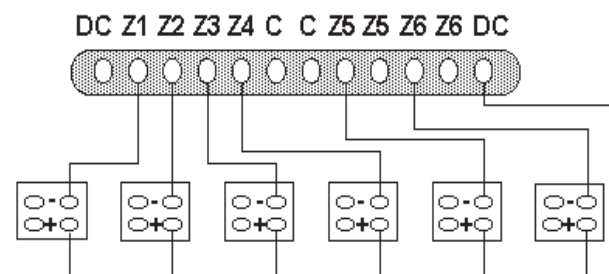

1. CONNECT ALL POSITIVE TERMINALS TOGETHER (3-32 V.DC.)
 2. CONNECT THEM TO THE DC TERMINAL AS SHOWN
 3. CONNECT ALL NEGATIVE TERMINALS TO THE INDIVIDUAL ZONES.
- NOTE: ZONES 5 AND 6 HAVE DUPLICATE TERMINALS.

2. USING EXTERNAL DC SUPPLY

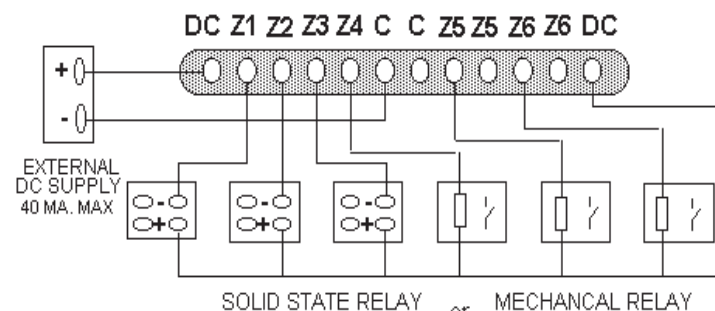

SOLID STATE RELAY or MECHANICAL RELAY

SOLID STATE OR MECHANICAL RELAYS CAN BE USED ON ANY ZONE

APPLICATION NOTES :

In order to operate CN616 Controller successfully it must be set up correctly for the application. The unit can be set manually or by the computer through RS232 link. Up to 10 units can be connected to a single RS232 port. The computer program is intuitive and does not require explanation. There are two features that can not be set by the computer.

1. Calibration. This requires lab setting for accuracy.
2. Unit number. To avoid conflict in communication.
If number of units are linked together, care must be taken to avoid duplication of unit identification numbers.

CN616 has 3 operating modes.

1. STANDARD MODE
2. RAMP AND SOAK1 [Profile]
3. RAMP AND SOAK2 [Profile]

The difference between RAMP AND SOAK1 & 2 is what happens at the end of profile run. In RAMP AND SOAK1 after last segment is finished the power is turned off, while in RAMP AND SOAK2 after the last segment is finished the temperature will be controlled at the last setpoint indefinitely or until profile is started again.

STANDARD MODE

Setpoints for STANDARD MODE are set in function 36.

Each zone runs independently of other zones. I.e.:- zone 1 may have PID control, zone 2 may have on/off control, and zone 3 may be set to cooling, [outputs reversed]. The only common things to all zones are PID parameters and thermocouple type. Any zone can be turned off during run by function 31.

RAMP AND SOAK [Profile] MODE.

Setpoints for Profile are set in function 75 [01 to 20]

To run Profile model code must be set to 51 or 52.[function 33]

Until Profile is started by function 79, all zones will run in STANDARD MODE. Function 79 can start Profile for any single zone or all zones at once.

In profile run control starts at ambient temperature, ambient temperature becomes first setpoint and is advanced to the first segment setpoint at the rate of the first segments slope. Profile run will continue until last segment is reached, as set by function 74. Profile can be restarted at any time for any one zone or all zones at once.

SETTING CN 616 TC1 TO CONTROL 4 ZONE FURNACE.

Configuration:

Zone	Setpoint	Alarms	
		HI	LO
1	400°F	15°F	20°F
2	500°F	15°F	15°F
3	530°F	15°F	20°F
4	300°F	20°F	20°F

Alarms Non latching

Thermocouple Type “K”

Autotune on Zone 2

Heaters, 120 VAC , 500 watt each

Controller power, 120 VAC

Drivers :-

Solid State Relays (Omega type SSRL240DC25) or equivalent.

INSTALLATION:-

Install the controller as instructed in the USER GUIDE Manual page 15.

Wire the power terminals - manual page 17

Wire the thermocouples as shown - manual page 20

NOTE :-

Since it is a 4 zone furnace, use only 4 type “K” thermocouples on zones 1, 2, 3, &4.

Short terminals 5 & 6 with copper wires. To avoid shorting thermocouples to the Electric heaters or grounds, use ungrounded and shielded thermocouples.

Wire controller outputs as shown in the Manual page 40. Use only 4 outputs Z1, Z2, Z3, & Z4. Do not connect anything to terminals Z5 & Z6. Do NOT power the heaters at this time.

Setup - Power the CN 616 controller

1. MODEL SELECTION.

To comply with the requirements, the following model must be selected:

Standard control, Hi / Lo Alarm with Non Latching Relay, °F.

Type “K” thermocouple

Looking on page 28 in the Manual the model will be coded as: 2 3 0 4.

2 - Hi / Lo Alarm

3 - Non latching relay, *F

0 - Standard control

4 - Type “K” thermocouple

Using procedure outlined on the inside back cover of this reference card, load the above model number into the controller.

NOTE -

If Function 99 appears during setup- it means that the password protection is enabled. Follow instructions on page 25 of the Manual to enter the password. Password is factory preset at 1 0 1 1. It may be a good idea to disable the Password protection at this time. Use procedure on page 27 and load “0” in Function 32. If password protection is desired, enable the password after the Controller setup is completed.

2. ZONE DISABLE - Page 27

Since only 4 zones are used, zones 5 & 6 should be disabled. Using setup procedure outlined above set 31 within the Function 71 and follow the zone enable procedure in the Manual on page 27.

3. ZONE DISPLAY TIME - Page 29

Using the setup procedure outlined above set 35 within Function 71 and follow the Zone display time instructions in the Manual on page 29.

4. SET SETPOINT - Page 29

Using setup procedure outlined on the inside back cover of this reference card, select Function 72 instead of 71. Select sub function 36 (Setpoint) and follow the procedure

On page 29 of the Manual to load the following setpoints :

Z1 - 400 ° F

Z2 - 500 ° F

Z3 - 530 ° F

Z4 - 300 ° F

Skip zones 5 & 6.

5. HIGH ALARMS - Page 30

Select Function 72 as above, select sub function 37 (Hi - Alarm). Follow the procedure Outlined on page 30 in the Manual and set the following alarms :

Z1 - 15 ° F

Z2 - 15 ° F

Z3 - 15 ° F

Z4 - 20 ° F

6. LOW ALARMS - Page 30

Select Function 72 as above, select sub function 38 (Lo Alarm). Follow the procedure Since only 4 zones are used, zones 5 & 6 should be disabled. Using setup procedure

Z1 - 20 ° F

Z2 - 15 ° F

Z3 - 20 ° F

Z4 - 20 ° F

7. PID CONTROL - Pages 31, 32, 33.

Even with the AUTOTUNE system certain parameters must be set manually, these are :

CYCLE TIME - Minimum recommended 4 seconds

HYSTERESIS - Typical 1 ° F

PID ZONES - Z1, Z2, Z3, Z4.

COOLING ZONES - None

Using the procedures outlined on pages 31, 32 & 33 of the manual, load the above numbers.

8. AUTOTUNE SETPOINT AND ZONE - Page 35.

Using setup procedure outlined on the inside cover of this reference card, select Function 76 instead of 71. Read manual page 35 how to set and run AUTOTUNE. Write autotune Set point - 350°F and autotune Zone - 2

9. RUN AUTOTUNE - Page 35











Before starting autotune connect power to the heaters. Using the above procedure Select Function 77 and follow instructions on page 35 of the Manual. The autotune Process will start and will be completed within few minutes or few hours depending on the time constants of the furnace system. Upon completion the controller will Control the temperature of the furnace within the specified parameters.

SETTING CN 616 TC1 TO CONTROL 4 ZONE FURNACE. TO RUN IN "RAMP AND SOAK1" MODE [Profile]

The difference between STANDARD MODE and RAMP AND SOAK MODE is that in RAMP AND SOAK controller can run up to 20 control segments for each zone. The first segment, for each zone, is made up of target temperature and rate of change (ramp). Subsequent segments are made up of setpoint, slope and time. Only one parameter (slope or time) need to be set. If time is set when new setpoint is different from the previous one, time will be converted to slope. The other parameter should be set at 0. If slope is set for the segment with no change in setpoint, the segment will be ignored and control will go to the next segment.



To run RAMP AND SOAK, CN616TC1 must be installed and set up as described in STANDARD MODE, then MODEL mode must be changed to 51 or 52 function 33 [p37]. Set number of segments function 74 [p33]. And set segments function 75 sub function 01 to 20 [p34]. When all is set correctly to run PROFILE it must be started by function 79 [p37]. Until PROFILE is started controller will run in STANDARD MODE, controlling to the STANDARD MODE setpoint. Function 79 will start profile for any single zone, or all zones at once. In the first segment starting setpoint is set at the ambient temperature and is changed at the rate of slope of the first segment.

EXAMPLE: Set Number of Profile Segments in each Zone

Action	Buttons to use	Display Before	Display After
1. Enter Setup mode	  together	0 4 0 3 1 5 1	=> 7 1 7 0
2. Select Function 74 (set the number of profile segments in each zone)		7 1 7 0	=> 7 4
Enter		7 4 7 0	=> 7 0 7 4
3. Confirm Selection		7 0 7 4	=> 7 4
Enter		7 4 7 4	=> 0 1 7 4
4. Set the Number of Profile Segments	use  &  to set # to 00-20	0 0 1 7 4	=> 0 5
Enter [the zone number increments repeat step 4. for the next zone]		0 5 1 7 4	=> 0 0 2 7 4
5. EXIT Function (at any time)	  together	0 5 6 7 4	=> 0 4 0 3 1 5 1

EXAMPLE: Program Profile Segment Settings

Set Profile Setpoint, Slope & Time for each Segment in each Zone (Large profiles are easily entered using the software. They can be modified manually using this procedure.)

Action	Buttons to use	Display Before	Display After
1. Enter Setup mode	  together	0 4 0 3 1 5 1	=> 7 1 7 0
2. Select Function 75 (set the profile segment settings in each zone)		7 1 7 0	=> 7 5

- | | | | | | |
|----|---|-------------------------|--|----|--|
| | Enter | | <input type="text" value="75"/> | => | <input type="text" value="70"/> |
| 3. | Confirm Selection | | <input type="text" value="70"/> | => | <input type="text" value="75"/> |
| | Enter | | <input type="text" value="75"/> | => | <input type="text" value="01"/> |
| 4. | Set Temperature Setpoint | use & | <input type="text" value="0000"/> | => | <input type="text" value="0400"/> |
| | | to set # to 0000-9999 | <input type="text" value="1"/> <input type="text" value="01"/> | | |
| | Enter | | <input type="text" value="0400"/> | => | <input type="text" value="0000"/> |
| | | | <input type="text" value="1"/> <input type="text" value="01"/> | => | <input type="text" value="1"/> <input type="text" value="01"/> |
| 5. | Set Slope (degrees/min) | use & | <input type="text" value="000"/> | => | <input type="text" value="01.5"/> |
| | | to set # to 00.0-99.9 | <input type="text" value="1"/> <input type="text" value="01"/> | | |
| | Enter | | <input type="text" value="01.5"/> | => | <input type="text" value="00.00"/> |
| | | | <input type="text" value="1"/> <input type="text" value="01"/> | => | <input type="text" value="1"/> <input type="text" value="01"/> |
| 6. | Set Time (hours) | use & | <input type="text" value="0000"/> | => | <input type="text" value="00.00"/> |
| | | to set # to 00.00-99.99 | <input type="text" value="1"/> <input type="text" value="01"/> | | |
| | Enter and go to Next segment setpoint [Repeat Steps 4-6 for all set segments] | | <input type="text" value="01.5"/> | => | <input type="text" value="0000"/> |
| | | | <input type="text" value="1"/> <input type="text" value="01"/> | => | <input type="text" value="1"/> <input type="text" value="02"/> |
| 7. | At any time EXIT Function | together | <input type="text" value="01.5"/> | => | <input type="text" value="0403"/> |
| | | | <input type="text" value="6"/> <input type="text" value="08"/> | => | <input type="text" value="1"/> <input type="text" value="51"/> |

Example: Program a profile with one segment in Zone 1 and two segments in Zone 2 use Function 74 to set Zone 1 to 01 and Zone 2 to 02 (make sure Zones 1 & 2 are enabled [Function 71\31] any enabled Zones 3-6 with 00 segments will run under Standard Control). Next use Function 75 to program the Temperature Setpoint in Zone 1 Segment 1 to 300°(Step 4.) Set the Slope to 15.0°/min(Step 5.) Set the Time to 05.00/min(Step 6.) (Time is ignored for control purposes when the Slope(Step 5.) in the segment is not 0.00°/min) There are no other segments in Zone 1. Press enter in Step 6. the Zone display(lower left) on the controller will change to program Zone 2 Segment 1(Step 4.) Program the settings for Zone 2. Start the profile with Function 79.(A Zone will maintain the Temperature of the end segment in a profile indefinitely in Ramp&Soak 2)

To run RAMP AND SOAK CN616TC1 MODEL the mode must be set to 51 or 52[Function 71\31]. Number of segments must be set for each enabled zone[Function 74]. Setting the number of segments to “00” will set that zone to run in STANDARD mode. PROFILE can only be started from Function 79 or the software. NOTE: For each zone until the PROFILE is started the controller will run that zone in STANDARD MODE, controlling at the STANDARD MODE setpoint.

Function 79 will start the profile for any single zone, or all zones at once. In the first segment the starting setpoint is set at the ambient temperature and is changed at the rate of slope of the first segment until the first segment setpoint is reached.

IMPORTANT!! To avoid overheating, zones intended for Profile run MUST have their Standard Setpoints set to 0. [Function 36]

EXAMPLE: Start Profile [Function 79]

- | Action | Buttons to use | Display Before | Display After |
|--|---|--|---|
| 1. Enter Setup mode | together | <input type="text" value="0403"/> | => <input type="text" value="71"/> |
| | | <input type="text" value="1"/> <input type="text" value="51"/> | => <input type="text" value="1"/> <input type="text" value="70"/> |
| 2. Select Function 79 | | <input type="text" value="71"/> | => <input type="text" value="79"/> |
| | | <input type="text" value="1"/> <input type="text" value="70"/> | |
| | Enter | <input type="text" value="79"/> | => <input type="text" value="0"/> |
| | | <input type="text" value="1"/> <input type="text" value="79"/> | => <input type="text" value="1"/> <input type="text" value="79"/> |
| 3. Select ONE Zone to Start Profile Run | | <input type="text" value="0"/> | => <input type="text" value="5"/> |
| | | <input type="text" value="1"/> <input type="text" value="79"/> | |
| | Enter [Start zone 5 Profile] | <input type="text" value="05"/> | => <input type="text" value="0403"/> |
| | | <input type="text" value="1"/> <input type="text" value="79"/> | => <input type="text" value="1"/> <input type="text" value="51"/> |
| OR | | | |
| 3. Select ALL Zones to Start Profile Run | | <input type="text" value="0"/> | => <input type="text" value="7"/> |
| | | <input type="text" value="1"/> <input type="text" value="79"/> | |
| | Enter [Start run on all enabled zones with 1 or more segments in the Profile] | <input type="text" value="07"/> | => <input type="text" value="0403"/> |
| | | <input type="text" value="1"/> <input type="text" value="79"/> | => <input type="text" value="1"/> <input type="text" value="51"/> |

WARRANTY/DISCLAIMER

OMEGA ENGINEERING, INC. warrants this unit to be free of defects in materials and workmanship for a period of **13 months** from date of purchase. OMEGA's WARRANTY adds an additional one (1) month grace period to the normal **one (1) year product warranty** to cover handling and shipping time. This ensures that OMEGA's customers receive maximum coverage on each product.

If the unit malfunctions, it must be returned to the factory for evaluation. OMEGA's Customer Service Department will issue an Authorized Return (AR) number immediately upon phone or written request. Upon examination by OMEGA, if the unit is found to be defective, it will be repaired or replaced at no charge. OMEGA's WARRANTY does not apply to defects resulting from any action of the purchaser, including but not limited to mishandling, improper interfacing, operation outside of design limits, improper repair, or unauthorized modification. This WARRANTY is VOID if the unit shows evidence of having been tampered with or shows evidence of having been damaged as a result of excessive corrosion; or current, heat, moisture or vibration; improper specification; misapplication; misuse or other operating conditions outside of OMEGA's control. Components in which wear is not warranted, include but are not limited to contact points, fuses, and triacs.

OMEGA is pleased to offer suggestions on the use of its various products. However, OMEGA neither assumes responsibility for any omissions or errors nor assumes liability for any damages that result from the use of its products in accordance with information provided by OMEGA, either verbal or written. OMEGA warrants only that the parts manufactured by the company will be as specified and free of defects. OMEGA MAKES NO OTHER WARRANTIES OR REPRESENTATIONS OF ANY KIND WHATSOEVER, EXPRESSED OR IMPLIED, EXCEPT THAT OF TITLE, AND ALL IMPLIED WARRANTIES INCLUDING ANY WARRANTY OF MERCHANTABILITY AND FITNESS FOR A PARTICULAR PURPOSE ARE HEREBY DISCLAIMED. LIMITATION OF LIABILITY: The remedies of purchaser set forth herein are exclusive, and the total liability of OMEGA with respect to this order, whether based on contract, warranty, negligence, indemnification, strict liability or otherwise, shall not exceed the purchase price of the component upon which liability is based. In no event shall OMEGA be liable for consequential, incidental or special damages.

CONDITIONS: Equipment sold by OMEGA is not intended to be used, nor shall it be used: (1) as a "Basic Component" under 10 CFR 21 (NRC), used in or with any nuclear installation or activity; or (2) in medical applications or used on humans. Should any Product(s) be used in or with any nuclear installation or activity, medical application, used on humans, or misused in any way, OMEGA assumes no responsibility as set forth in our basic WARRANTY/DISCLAIMER language, and, additionally, purchaser will indemnify OMEGA and hold OMEGA harmless from any liability or damage whatsoever arising out of the use of the Product(s) in such a manner.

RETURN REQUESTS/INQUIRIES

Direct all warranty and repair requests/inquiries to the OMEGA Customer Service Department. BEFORE RETURNING ANY PRODUCT(S) TO OMEGA, PURCHASER MUST OBTAIN AN AUTHORIZED RETURN (AR) NUMBER FROM OMEGA'S CUSTOMER SERVICE DEPARTMENT (IN ORDER TO AVOID PROCESSING DELAYS). The assigned AR number should then be marked on the outside of the return package and on any correspondence.

The purchaser is responsible for shipping charges, freight, insurance and proper packaging to prevent breakage in transit.

FOR **WARRANTY** RETURNS, please have the following information available BEFORE contacting OMEGA:

1. Purchase Order number under which the product was PURCHASED,
2. Model and serial number of the product under warranty, and
3. Repair instructions and/or specific problems relative to the product.

FOR **NON-WARRANTY** REPAIRS, consult OMEGA for current repair charges. Have the following information available BEFORE contacting OMEGA:

1. Purchase Order number to cover the COST of the repair,
2. Model and serial number of the product, and
3. Repair instructions and/or specific problems relative to the product.

OMEGA's policy is to make running changes, not model changes, whenever an improvement is possible. This affords our customers the latest in technology and engineering.

OMEGA is a registered trademark of OMEGA ENGINEERING, INC.

© Copyright 2017 OMEGA ENGINEERING, INC. All rights reserved. This document may not be copied, photocopied, reproduced, translated, or reduced to any electronic medium or machine-readable form, in whole or in part, without the prior written consent of OMEGA ENGINEERING, INC.

Where Do I Find Everything I Need for Process Measurement and Control? **OMEGA...Of Course!** *Shop online at omega.comSM*

TEMPERATURE

- ☑ Thermocouple, RTD & Thermistor Probes, Connectors, Panels & Assemblies
- ☑ Wire: Thermocouple, RTD & Thermistor
- ☑ Calibrators & Ice Point References
- ☑ Recorders, Controllers & Process Monitors
- ☑ Infrared Pyrometers

PRESSURE, STRAIN AND FORCE

- ☑ Transducers & Strain Gages
- ☑ Load Cells & Pressure Gages
- ☑ Displacement Transducers
- ☑ Instrumentation & Accessories

FLOW/LEVEL

- ☑ Rotameters, Gas Mass Flowmeters & Flow Computers
- ☑ Air Velocity Indicators
- ☑ Turbine/Paddlewheel Systems
- ☑ Totalizers & Batch Controllers

pH/CONDUCTIVITY

- ☑ pH Electrodes, Testers & Accessories
- ☑ Benchtop/Laboratory Meters
- ☑ Controllers, Calibrators, Simulators & Pumps
- ☑ Industrial pH & Conductivity Equipment

DATA ACQUISITION

- ☑ Communications-Based Acquisition Systems
- ☑ Data Logging Systems
- ☑ Wireless Sensors, Transmitters, & Receivers
- ☑ Signal Conditioners
- ☑ Data Acquisition Software

HEATERS

- ☑ Heating Cable
- ☑ Cartridge & Strip Heaters
- ☑ Immersion & Band Heaters
- ☑ Flexible Heaters
- ☑ Laboratory Heaters

ENVIRONMENTAL MONITORING AND CONTROL

- ☑ Metering & Control Instrumentation
- ☑ Refractometers
- ☑ Pumps & Tubing
- ☑ Air, Soil & Water Monitors
- ☑ Industrial Water & Wastewater Treatment
- ☑ pH, Conductivity & Dissolved Oxygen Instruments