

# Basic Connector Dimensions



Most Popular **Standard** Connectors



## OSTW

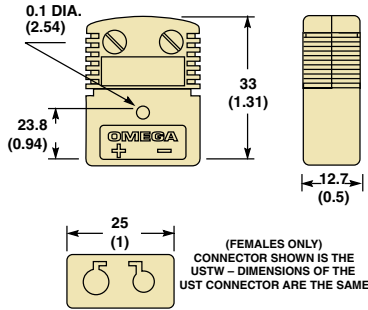

## OSTW & HSTW

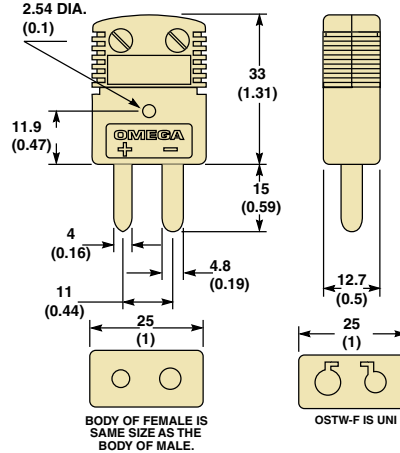

## OSTW-CC

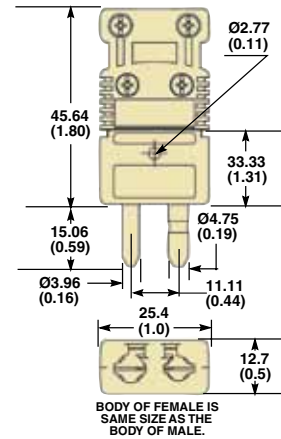

## OGP

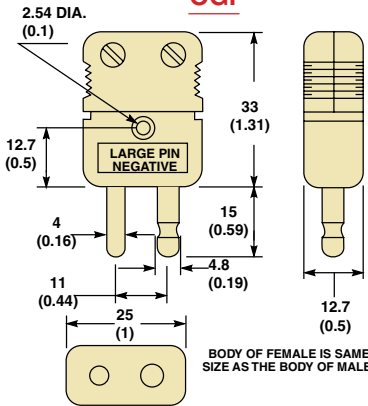

## DTC

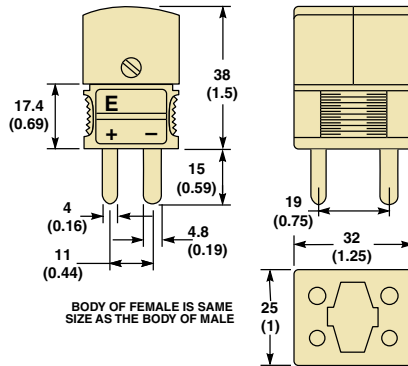

## NHX & NHXH

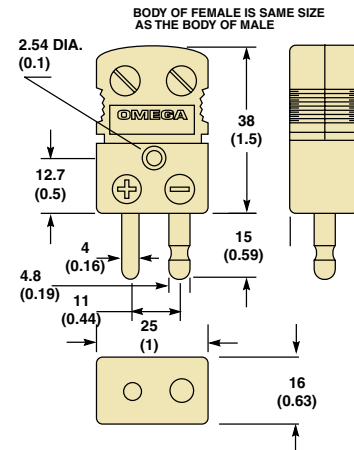

## NOX

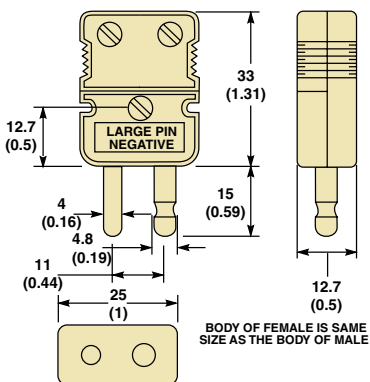

## OTP

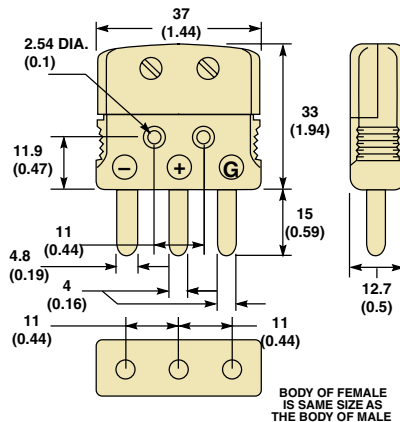

## GST (HGST)

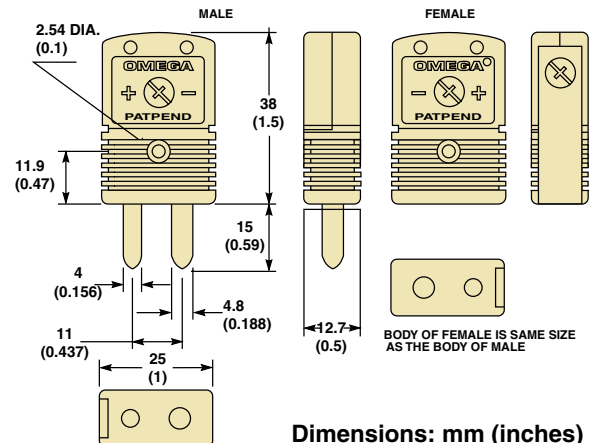

Dimensions: mm (inches)

# Basic Connector Dimensions

## Most Popular **Miniature** Connectors and Circuit Board Connectors

### HMPW, SMPW & SMP

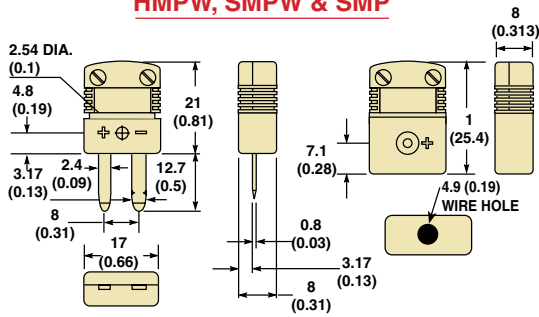

### NMP

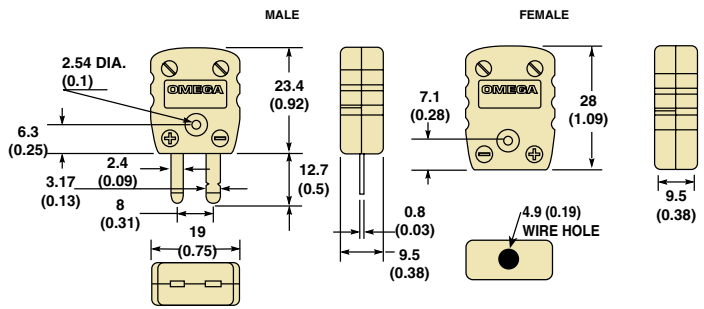

### SHX & USHX

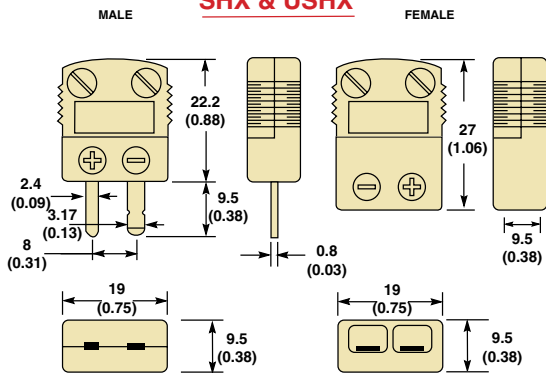

### GMP & HGMP

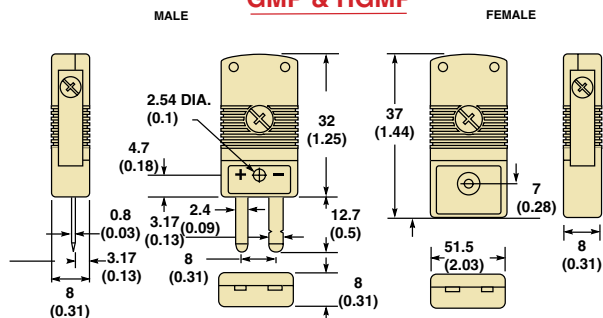

### MTP

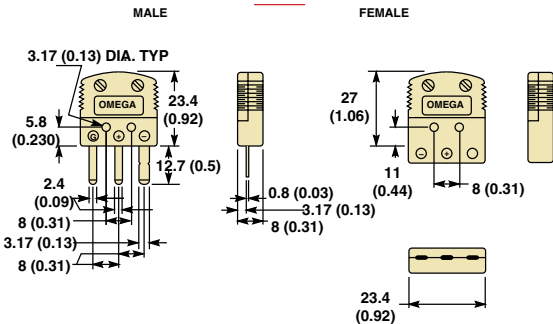

### PCC-OST

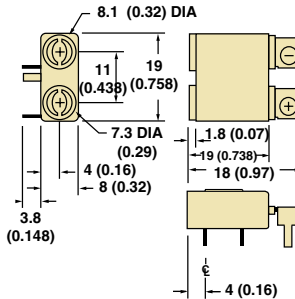

### PCC-SMP

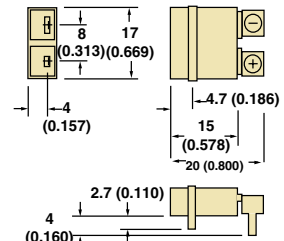

### PCC-SMP-V

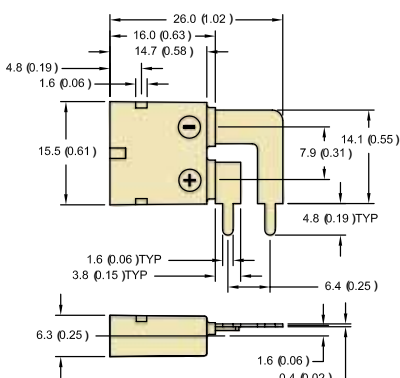

### SMPW-CC

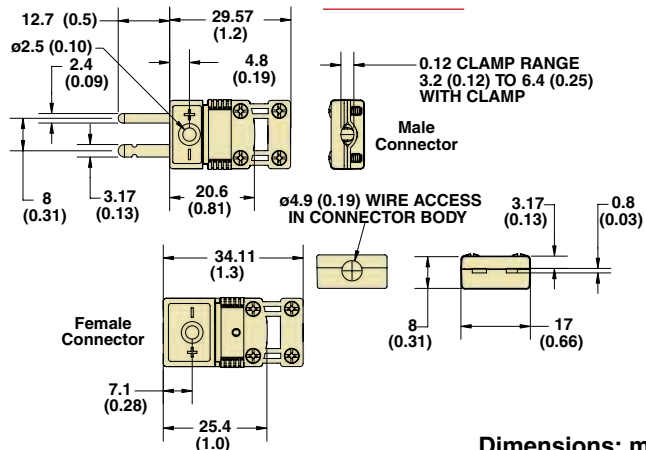

Dimensions: mm (inches)

# Basic Connector Dimensions

## Most Popular Transition and Panel Connectors

**TAS-U-5**

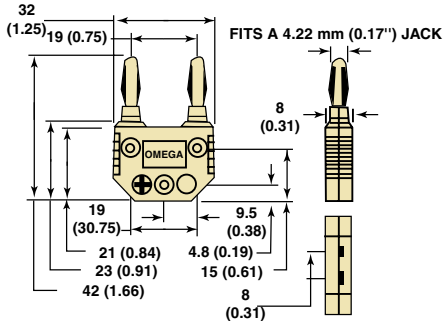

**TAS-( )-( )**

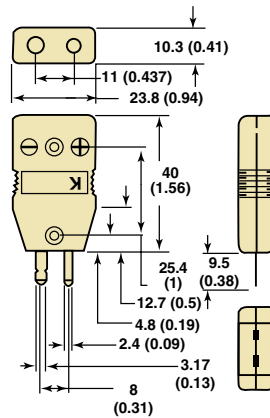

**UPJ**

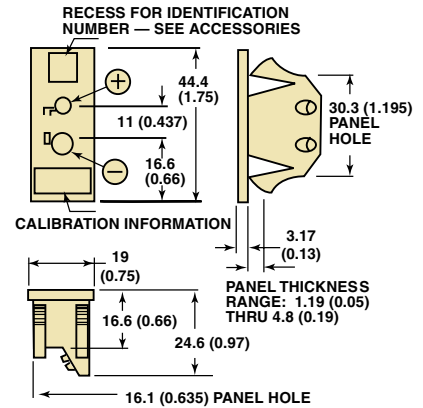

**UPF and SPJ**

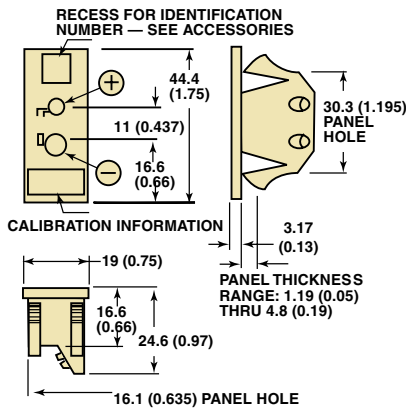

**JP**

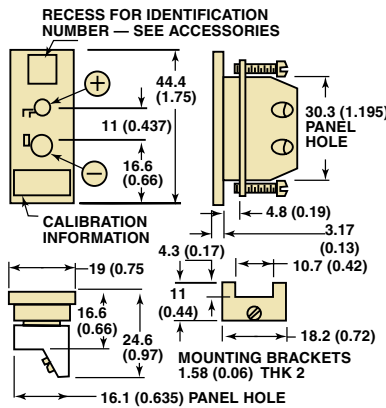

**TPJ**

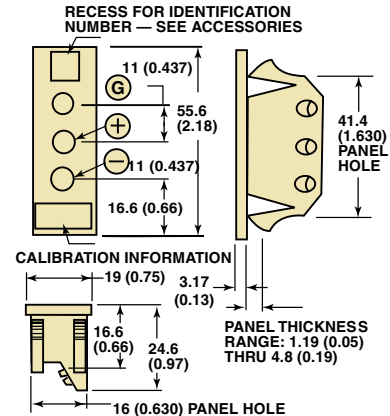

**RSJ-( ) S & R**

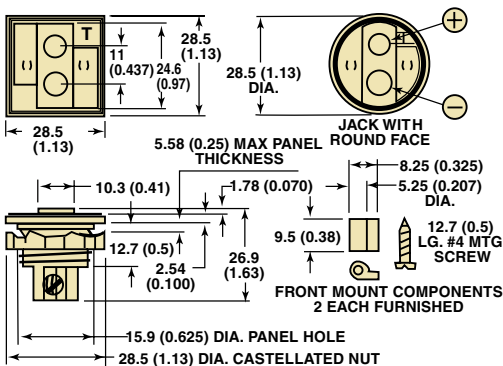

**RMJ-S RMJ-R**

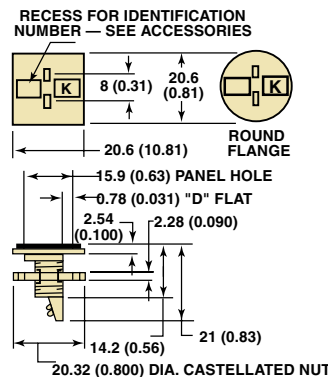

**MPJ**

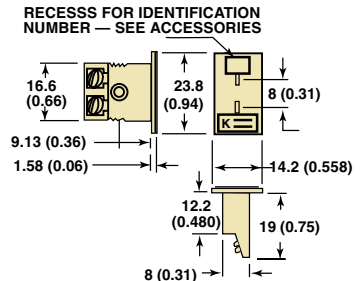

Dimensions: mm (inches)

# Basic Connector Dimensions

## Most Popular Multipin and Miscellaneous Connectors

**MTC ( ) FF**

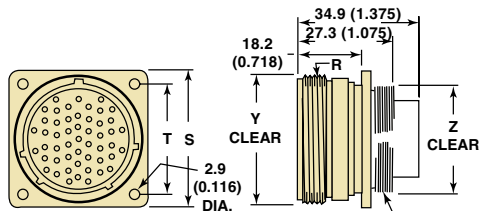

PINS	T	S	Y	Z	M THRD.	R THRD.
5	18.26 (0.72)	23.88 (0.94)	19.05 (0.75)	14.48 (0.57)	0.562-24 UNEF	0.687-24
12	20.62 (0.81)	26.16 (1.03)	23.11 (0.91)	19.30 (0.76)	0.750-20 UNEF	0.875-20
24	24.61 (0.97)	31.75 (1.25)	28.19 (1.11)	24.13 (0.95)	0.937-20 UNEF	1.062-18
41	29.36 (1.16)	36.58 (1.44)	33.78 (1.33)	30.48 (1.20)	1.187-18 UNEF	1.312-18
55	31.75 (1.25)	39.62 (1.56)	36.83 (1.45)	33.53 (1.32)	1.312-18 UNEF	1.437-18

**FC & MC**

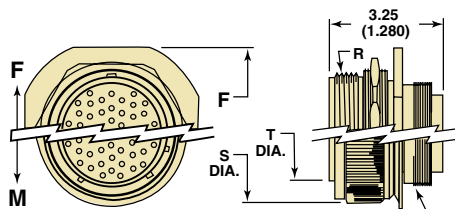

PINS	S	T	F	M THRD.	R THRD.
5	21.08 (0.83)	13.46 (0.53)	27.67 (1.09)	0.562-24	0.687-24
12	25.15 (0.99)	17.78 (0.70)	32.77 (1.29)	0.750-20	0.875-20
24	30.23 (1.19)	22.61 (0.89)	38.61 (1.52)	0.937-20	1.062-18
41	36.07 (1.42)	28.45 (1.12)	45.97 (1.81)	1.187-18	1.312-18
55	39.37 (1.55)	31.75 (1.25)	49.53 (1.95)	1.312-18	1.437-18

**MTC**

**MSP**

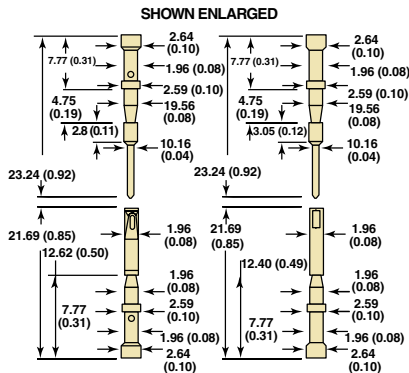

**SMTC**

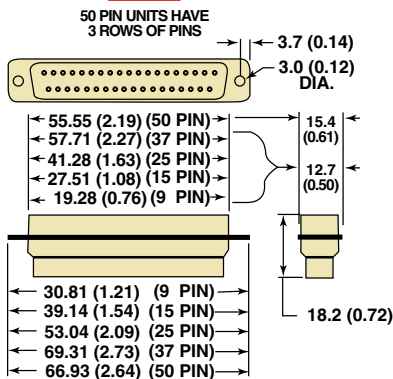

**SMTC PINS**

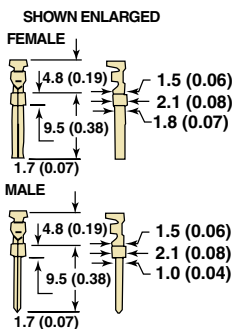

**TA ( ) F**

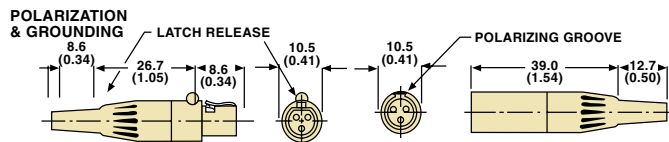

**TA ( ) M**

**TA ( ) FL**

**TA ( ) ML**



ALL DIMENSIONS SAME AS SHOWN ABOVE

**BS**

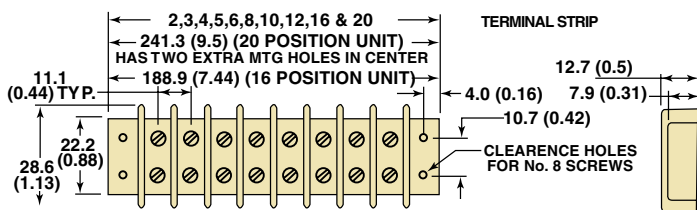

**TL**

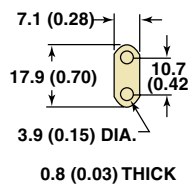

**SL**

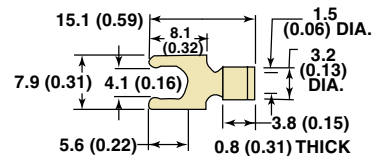

**TY**

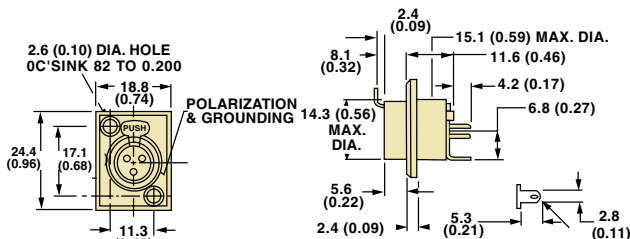

**TB**

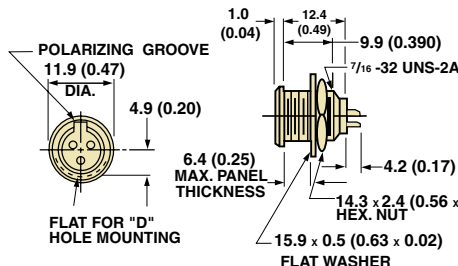

**CH6 ( )**

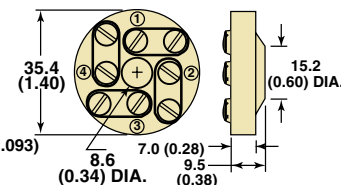

Dimensions: mm (inches)