

# Practical Temperature Measurements\*







	<b>Thermocouple</b>  	<b>RTD</b>  	<b>Thermistor</b>  	<b>I. C. Sensor</b>  
	<input type="checkbox"/> Self-powered <input type="checkbox"/> Simple <input type="checkbox"/> Rugged <input type="checkbox"/> Inexpensive <input type="checkbox"/> Wide variety <input type="checkbox"/> Wide temperature range	<input type="checkbox"/> Most stable <input type="checkbox"/> Most accurate <input type="checkbox"/> More linear than thermocouple	<input type="checkbox"/> High output <input type="checkbox"/> Fast <input type="checkbox"/> Two-wire ohms measurement	<input type="checkbox"/> Most linear <input type="checkbox"/> Highest output <input type="checkbox"/> Inexpensive
<b>Disadvantages</b>	<input type="checkbox"/> Non-linear <input type="checkbox"/> Low voltage <input type="checkbox"/> Reference required <input type="checkbox"/> Least stable <input type="checkbox"/> Least sensitive	<input type="checkbox"/> Expensive <input type="checkbox"/> Current source required <input type="checkbox"/> Small $\Delta R$ <input type="checkbox"/> Low absolute resistance <input type="checkbox"/> Self-heating	<input type="checkbox"/> Non-linear <input type="checkbox"/> Limited temperature range <input type="checkbox"/> Fragile <input type="checkbox"/> Current source required <input type="checkbox"/> Self-heating	<input type="checkbox"/> $T < 200^{\circ}\text{C}$ <input type="checkbox"/> Power supply required <input type="checkbox"/> Slow <input type="checkbox"/> Self-heating <input type="checkbox"/> Limited configurations

Figure 1

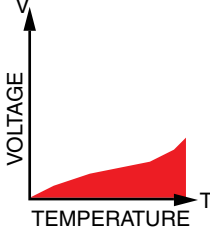
## TABLE OF CONTENTS

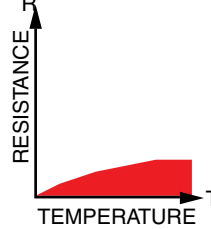
### APPLICATION NOTES-PRACTICAL TEMPERATURE MEASUREMENTS

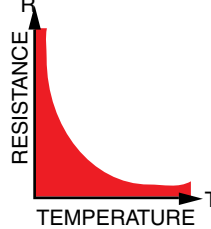
	<b>Page</b>
<b>Common Temperature Transducers</b> .....	<b>Z-19</b>
<b>Introduction</b> .....	<b>Z-20</b>
Reference Temperatures.....	<b>Z-21</b>
<b>The Thermocouple</b> .....	<b>Z-21</b>
Reference Junction.....	<b>Z-22</b>
Reference Circuit.....	<b>Z-23</b>
Hardware Compensation.....	<b>Z-24</b>
Voltage-to-Temperature Conversion.....	<b>Z-25</b>
<b>Practical Thermocouple Measurement</b> .....	<b>Z-27</b>
Noise Rejection.....	<b>Z-27</b>
Poor Junction Connection.....	<b>Z-29</b>
Decalibration.....	<b>Z-29</b>
Shunt Impedance.....	<b>Z-29</b>
Galvanic Action.....	<b>Z-30</b>
Thermal Shunting.....	<b>Z-30</b>
Wire Calibration.....	<b>Z-30</b>
Diagnostics.....	<b>Z-31</b>
Summary.....	<b>Z-32</b>
<b>The RTD</b> .....	<b>Z-33</b>
History.....	<b>Z-33</b>
Metal Film RTD's.....	<b>Z-33</b>
Resistance Measurement.....	<b>Z-34</b>
3-Wire Bridge Measurement Errors.....	<b>Z-35</b>
Resistance to Temperature Conversion.....	<b>Z-35</b>
Practical Precautions.....	<b>Z-36</b>

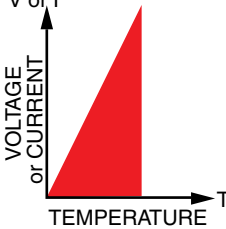
\* Copyright © 1997, 2000 Agilent Technologies, Inc. Reproduced with Permission.

# TABLE OF CONTENTS

## APPLICATION NOTES-PRACTICAL TEMPERATURE MEASUREMENTS (con't)

<b>The Thermistor</b> .....	<b>Z-36</b>
Linear Thermistors .....	<b>Z-37</b>
Measurement .....	<b>Z-37</b>
<b>Monolithic Linear Temperature Sensor</b> .....	<b>Z-37</b>
<b>Appendix A-The Empirical Laws of Thermocouples</b> .....	<b>Z-37</b>
<b>Appendix B</b> .....	<b>Z-38</b>
Thermocouple Characteristics .....	<b>Z-38</b>
Base Metal Thermocouples .....	<b>Z-38</b>
<b>Standard Wire Errors</b> .....	<b>Z-39</b>
<b>Bibliography</b> .....	<b>Z-40</b>

Z

Synthetic fuel research, solar energy conversion and new engine development are but a few of the burgeoning disciplines responding to the state of our dwindling natural resources. As all industries place new emphasis on energy efficiency, the fundamental measurement of temperature assumes new importance. The purpose of this application note is to explore the more common temperature monitoring techniques and introduce procedures for improving their accuracy.

We will focus on the four most common temperature transducers: the thermocouple, the RTD, the thermistor and the integrated circuit sensor. Despite the widespread popularity of the thermocouple, it is frequently misused. For this reason, we will concentrate primarily on thermocouple measurement techniques.

Appendix A contains the empirical laws of thermocouples which are the basis for all derivations used herein. Readers wishing a more thorough discussion of thermocouple theory are invited to read REFERENCE 17 in the Bibliography.

For those with a specific thermocouple application, Appendix B may aid in choosing the best type of thermocouple.

Throughout this application note, we will emphasize the practical considerations of transducer placement, signal conditioning and instrumentation.

**Early Measuring Devices** - Galileo is credited with inventing the thermometer, circa 1592.<sup>1,2,3</sup> In an open container filled with colored alcohol he suspended a long narrow-throated glass tube, at the upper end of which was a hollow sphere. When heated, the air in the sphere expanded and bubbled through the liquid. Cooling the sphere caused the liquid to move up the tube.<sup>1</sup> Fluctuations in the temperature of the sphere could then be observed by noting the position of the liquid inside the tube. This “upside-down” thermometer was a poor indicator since the level changed with barometric pressure and the tube had no scale. Vast improvements were made in temperature measurement accuracy with the development of the

Florentine thermometer, which incorporated sealed construction and a graduated scale.

In the ensuing decades, many thermometric scales were conceived, all based on two or more fixed points. One scale, however, wasn’t universally recognized until the early 1700’s, when Gabriel Fahrenheit, a Dutch instrument maker, produced accurate and repeatable mercury thermometers. For the fixed point on the low end of his temperature scale, Fahrenheit used a mixture of ice water and salt (or ammonium chloride). This was the lowest temperature he could reproduce, and he labeled it “zero degrees”. For the high end of his scale, he chose human blood temperature and called it 96 degrees.

Why 96 and not 100 degrees? Earlier scales had been divided into twelve parts. Fahrenheit, in an apparent quest for more resolution divided his scale into 24, then 48 and eventually 96 parts.

The Fahrenheit scale gained popularity primarily because of the repeatability and quality of the thermometers that Fahrenheit built.

Around 1742, Anders Celsius proposed that the melting point of ice and the boiling point of water be used for the two benchmarks. Celsius selected zero degrees as the boiling point and 100 degrees as the melting point. Later, the end points were reversed and the centigrade scale was born. In 1948 the name was officially changed to the Celsius scale.

In the early 1800’s William Thomson (Lord Kelvin), developed a universal thermodynamic scale based upon the coefficient of expansion of an ideal gas. Kelvin established the concept of absolute zero and his scale remains the standard for modern thermometry.

The conversion equations for the four modern temperature scales are:

$$^{\circ}\text{C} = 5/9 (^{\circ}\text{F} - 32) \quad ^{\circ}\text{F} = 9/5 ^{\circ}\text{C} + 32$$

$$\text{K} = ^{\circ}\text{C} + 273.15 \quad ^{\circ}\text{R} = ^{\circ}\text{F} + 459.67$$

The Rankine Scale (<sup>°</sup>R) is simply the Fahrenheit equivalent of the Kelvin scale, and was named after an early pioneer in the field of thermodynamics, W.J.M. Rankine.

<sup>1,2,3</sup> Refer to Bibliography 1,2,3.

# Reference Temperatures

We cannot build a temperature divider as we can a voltage divider, nor can we add temperatures as we would add lengths to measure distance. We must rely upon temperatures established by physical phenomena which are easily observed and consistent in nature. The International Practical Temperature Scale (IPTS) is based on such phenomena. Revised in 1968, it establishes eleven reference temperatures.

Since we have only these fixed temperatures to use as a reference, we must use instruments to interpolate between them. But accurately interpolating between these temperatures can require some fairly exotic transducers, many of which are too complicated or expensive to use in a practical situation. We shall limit our discussion to the four most common temperature transducers: thermocouples, resistance-temperature detector's (RTD's), thermistors, and integrated circuit sensors.

## IPTS-68 REFERENCE TEMPERATURES

EQUILIBRIUM POINT	K	°C
Triple Point of Hydrogen	13.81	-259.34
Liquid/Vapor Phase of Hydrogen at 25/76 Std. Atmosphere	17.042	-256.108
Boiling Point of Hydrogen	20.28	-252.87
Boiling Point of Neon	27.102	-246.048
Triple Point of Oxygen	54.361	-218.789
Boiling Point of Oxygen	90.188	-182.962
Triple Point of Water	273.16	0.01
Boiling Point of Water	373.15	100
Freezing Point of Zinc	692.73	419.58
Freezing Point of Silver	1235.08	961.93
Freezing Point of Gold	1337.58	1064.43

Table 1

## THE THERMOCOUPLE

When two wires composed of dissimilar metals are joined at both ends and one of the ends is heated, there is a continuous current which flows in the *thermoelectric* circuit. Thomas Seebeck made this discovery in 1821.

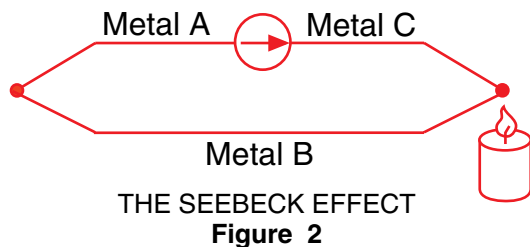

If this circuit is broken at the center, the net open circuit voltage (the Seebeck voltage) is a function of the junction temperature and the composition of the two metals.

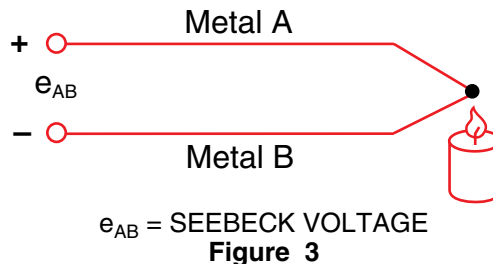

All dissimilar metals exhibit this effect. The most common combinations of two metals are listed in **Appendix B** of this application note, along with their important characteristics. For small changes in temperature the Seebeck voltage is linearly proportional to temperature:

$$e_{AB} = T$$

Where  $\alpha$ , the Seebeck coefficient, is the constant of proportionality.

**Measuring Thermocouple Voltage** - We can't measure the Seebeck voltage directly because we must first connect a voltmeter to the thermocouple, and the voltmeter leads themselves create a new thermoelectric circuit.

Let's connect a voltmeter across a copper-constantan (Type T) thermocouple and look at the voltage output:

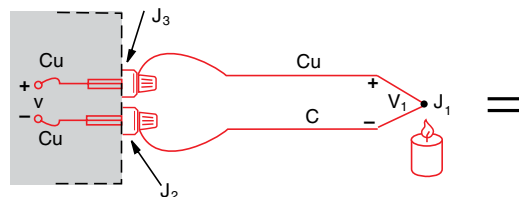

EQUIVALENT CIRCUITS

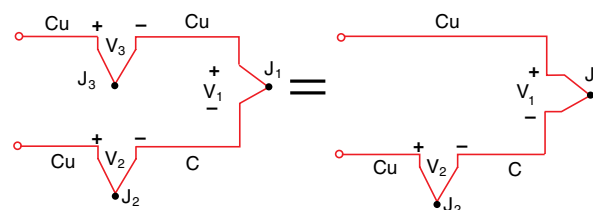

MEASURING JUNCTION VOLTAGE WITH A DVM  
Figure 4

We would like the voltmeter to read only  $V_1$ , but by connecting the voltmeter in an attempt to measure the output of Junction  $J_1$ , we have created two more metallic junctions:  $J_2$  and  $J_3$ . Since  $J_3$  is a copper-to-copper junction, it creates no thermal EMF ( $V_3 = 0$ ), but  $J_2$  is a copper-to-constantan junction which will add an EMF ( $V_2$ ) in opposition to  $V_1$ . The resultant voltmeter reading  $V$  will be proportional to the temperature difference between  $J_1$  and  $J_2$ . This says that we can't find the temperature at  $J_1$  unless we first find the temperature of  $J_2$ .

# The Reference Junction

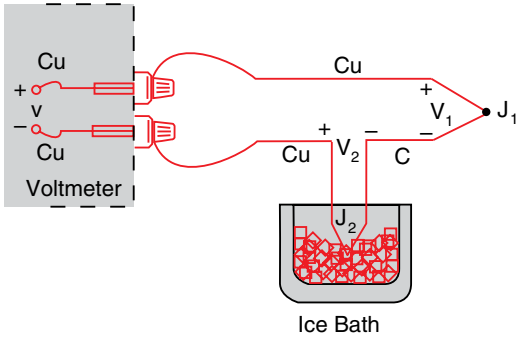

EXTERNAL REFERENCE JUNCTION

Figure 5

One way to determine the temperature of  $J_2$  is to physically put the junction into an ice bath, forcing its temperature to be  $0^\circ\text{C}$  and establishing  $J_2$  as the *Reference Junction*. Since both voltmeter terminal junctions are now copper-copper, they create no thermal emf and the reading  $V$  on the voltmeter is proportional to the temperature difference between  $J_1$  and  $J_2$ .

Now the voltmeter reading is (see Figure 5):

$$V = V_1 - V_2 \cong \alpha(t_{J_1} - t_{J_2})$$

If we specify  $T_{J_1}$  in degrees Celsius:

$$T_{J_1} (^\circ\text{C}) + 273.15 = t_{J_1}$$

then  $V$  becomes:

$$V = V_1 - V_2 = \alpha [(T_{J_1} + 273.15) - (T_{J_2} + 273.15)] \\ = \alpha (T_{J_1} - T_{J_2}) = \alpha (T_{J_1} - 0)$$

$$V = \alpha T_{J_1}$$

We use this protracted derivation to emphasize that the ice bath junction output,  $V_2$ , is *not* zero volts. It is a function of absolute temperature.

By adding the voltage of the ice point reference junction, we have now referenced the reading  $V$  to  $0^\circ\text{C}$ . This method is very accurate because the ice point temperature can be precisely controlled. The ice point is used by the National Bureau of Standards (NBS) as the fundamental reference point for their thermocouple tables, so we can now look at the NBS tables and directly convert from voltage  $V$  to Temperature  $T_{J_1}$ .

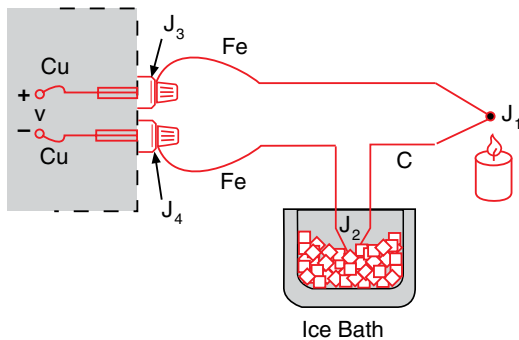

IRON-CONSTANTAN COUPLE

Figure 6

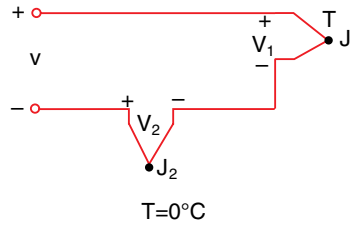

The copper-constantan thermocouple shown in Figure 5 is a unique example because the copper wire is the same metal as the voltmeter terminals. Let's use an iron-constantan (Type J) thermocouple instead of the copper-constantan. The iron wire (Figure 6) increases the number of dissimilar metal junctions in the circuit, as both voltmeter terminals become Cu-Fe thermocouple junctions.

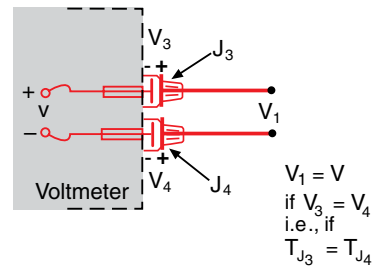

JUNCTION VOLTAGE CANCELLATION

Figure 7

If both front panel terminals are not at the same temperature, there will be an error. For a more precise measurement, the copper voltmeter leads should be extended so the copper-to-iron junctions are made on an *isothermal* (same temperature) block:

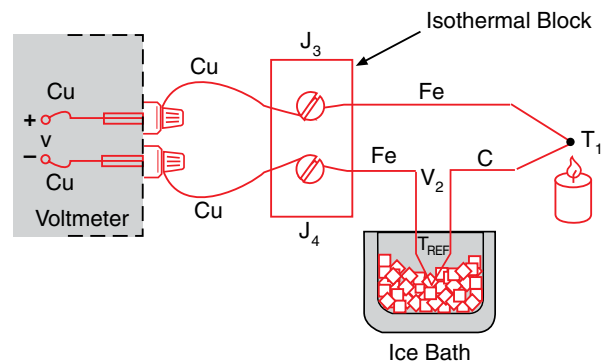

REMOVING JUNCTIONS FROM DVM TERMINALS

Figure 8

The isothermal block is an electrical insulator but a good heat conductor, and it serves to hold  $J_3$  and  $J_4$  at the same temperature. The absolute block temperature is unimportant because the two Cu-Fe junctions act in opposition. We still have

$$V = \alpha (T_1 - T_{REF})$$

# Reference Circuit

Let's replace the ice bath with another isothermal block

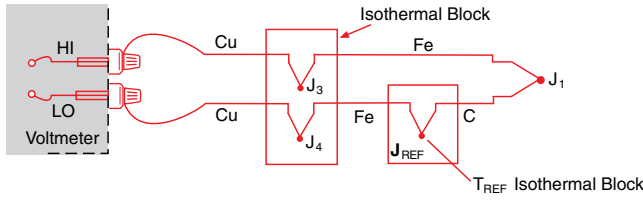

ELIMINATING THE ICE BATH

Figure 9a

The new block is at Reference Temperature  $T_{REF}$ , and because  $J_3$  and  $J_4$  are still at the same temperature, we can again show that

$$V = \alpha (T_1 - T_{REF})$$

This is still a rather inconvenient circuit because we have to connect two thermocouples. Let's eliminate the extra Fe wire in the negative (LO) lead by combining the Cu-Fe junction ( $J_4$ ) and the Fe-C junction ( $J_{REF}$ ).

We can do this by first joining the two isothermal blocks (Figure 9b).

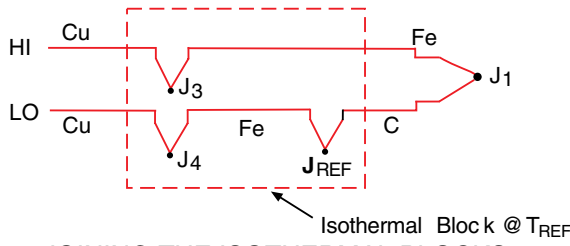

JOINING THE ISOTHERMAL BLOCKS

Figure 9b

We haven't changed the output voltage  $V$ . It is still

$$V = \alpha (T_{J_1} - T_{J_{REF}})$$

Now we call upon the law of intermediate metals (see Appendix A) to eliminate the extra junction. This empirical "law" states that a third metal (in this case, iron) inserted between the two dissimilar metals of a thermocouple junction will have no effect upon the output voltage as long as the two junctions formed by the additional metal are at the same temperature:

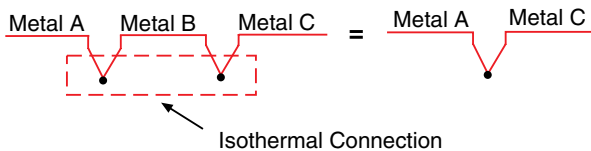

Thus the low lead in Fig. 9b:

Becomes:

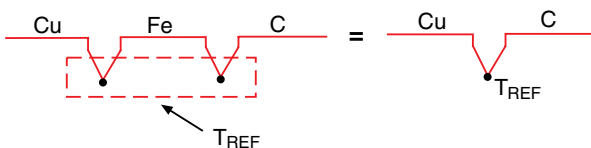

LAW OF INTERMEDIATE METALS

Figure 10

This is a useful conclusion, as it completely eliminates the need for the iron (Fe) wire in the LO lead:

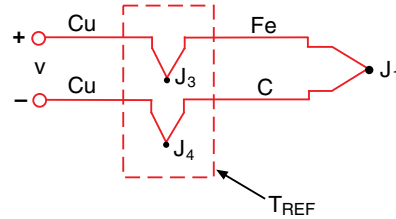

EQUIVALENT CIRCUIT

Figure 11

Again,  $V = \alpha (T_{J_1} - T_{REF})$ , where  $\alpha$  is the Seebeck coefficient for an Fe-C thermocouple.

Junctions  $J_3$  and  $J_4$ , take the place of the ice bath. These two junctions now become the *Reference Junction*.

Now we can proceed to the next logical step: Directly measure the temperature of the isothermal block (the *Reference Junction*) and use that information to compute the unknown temperature,  $T_{J_1}$ .

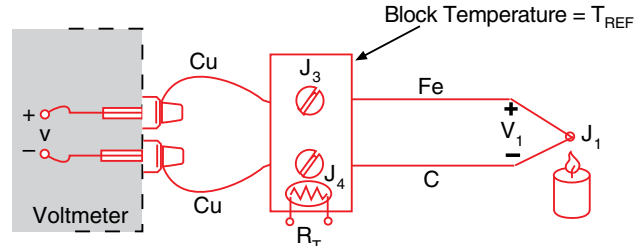

EXTERNAL REFERENCE JUNCTION-NO ICE BATH

Figure 12

A thermistor, whose resistance  $R_T$  is a function of temperature, provides us with a way to measure the absolute temperature of the reference junction. Junctions  $J_3$  and  $J_4$  and the thermistor are all assumed to be at the same temperature, due to the design of the isothermal block. Using a digital multimeter under computer control, we simply:

- 1) Measure  $R_T$  to find  $T_{REF}$  and convert  $T_{REF}$  to its equivalent reference junction voltage,  $V_{REF}$ , then
- 2) Measure  $V$  and add  $V_{REF}$  to find  $V_1$ , and convert  $V_1$  to temperature  $T_{J_1}$ .

This procedure is known as *Software Compensation* because it relies upon the software of a computer to compensate for the effect of the reference junction. The isothermal terminal block temperature sensor can be any device which has a characteristic proportional to absolute temperature: an RTD, a thermistor, or an integrated circuit sensor.

It seems logical to ask: If we already have a device that will measure absolute temperature (like an RTD or thermistor), why do we even bother with a thermocouple that requires reference junction

compensation? The single most important answer to this question is that the thermistor, the RTD, and the integrated circuit transducer are only useful over a certain temperature range. Thermocouples, on the other hand, can be used over a range of temperatures, and optimized for various atmospheres. They are much more rugged than thermistors, as evidenced by the fact that thermocouples are often welded to a metal part or clamped under a screw. They can be manufactured on the spot, either by soldering or welding. In short, thermocouples are the most versatile temperature transducers available and, since the measurement system performs the entire task of reference compensation and software voltage to-temperature conversion, using a thermocouple becomes as easy as connecting a pair of wires.

Thermocouple measurement becomes especially convenient when we are required to monitor a large number of data points. This is accomplished by using the isothermal reference junction for more than one thermocouple element (see Figure 13).

A reed relay scanner connects the voltmeter to the various thermocouples in sequence. All of the voltmeter and scanner wires are copper, independent of the type of thermocouple chosen. In fact, as long as we know what each thermocouple is, we can mix thermocouple types on the same isothermal junction block (often called a *zone box*) and make the appropriate modifications in software. The junction block temperature sensor  $R_T$  is located at the center of the block to minimize errors due to thermal gradients.

Software compensation is the most versatile technique we have for measuring thermocouples. Many thermocouples are connected on the same block, copper leads are used throughout the scanner, and the technique is independent of the types of thermocouples chosen. In addition, when using a data acquisition system with a built-in zone box, we simply connect the thermocouple as we would a pair of test leads. All of the conversions are performed by the computer. The one disadvantage is that the computer requires a small amount of additional time to calculate the reference junction temperature. For maximum speed we can use hardware compensation.

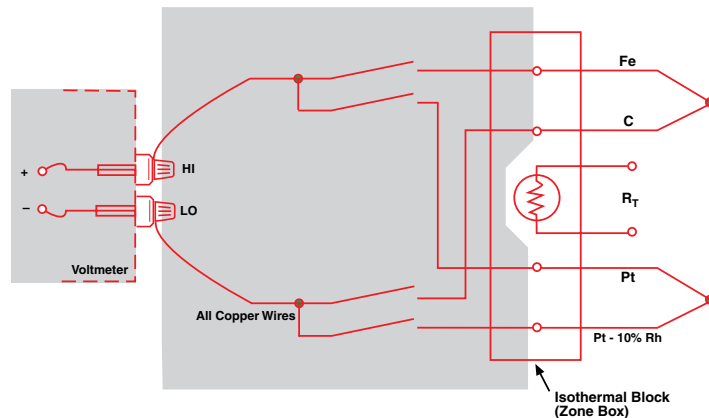

ZONE BOX SWITCHING  
Figure 13

## Hardware Compensation

Rather than measuring the temperature of the reference junction and computing its equivalent voltage as we did with software compensation, we could insert a battery to cancel the offset voltage of the reference junction. The combination of this *hardware compensation* voltage and the reference junction voltage is equal to that of a  $0^\circ\text{C}$  junction.

The compensation voltage,  $e$ , is a function of the temperature sensing resistor,  $R_T$ . The voltage  $V$  is now referenced to  $0^\circ\text{C}$ , and may be read directly and converted to temperature by using the NBS tables.

Another name for this circuit is the *electronic ice point reference*.<sup>6</sup> These circuits are commercially available for use with any voltmeter and with a wide variety of thermocouples. The major drawback is that a unique ice point reference circuit is usually needed for each individual thermocouple type.

Figure 15 shows a practical ice point reference circuit that can be used in conjunction with a reed relay scanner to compensate an entire block of thermocouple inputs. All the thermocouples in the block must be of the same type, but each block of inputs can accommodate a different thermocouple type by simply changing gain resistors.

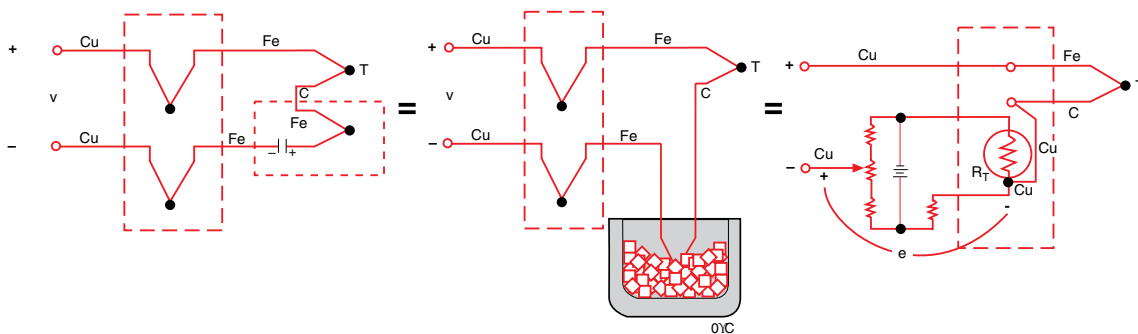

HARDWARE COMPENSATION CIRCUIT  
Figure 14

<sup>6</sup> Refer to Bibliography 6.



OMEGA TAC-Electronic ice point™ and Thermocouple Preamplifier/Linearizer Plugs into Standard Connector



OMEGA Electronic ice point™ Built into Thermocouple Connector -"MCJ"



OMEGA ice point™ Reference Chamber. Electronic Refrigeration Eliminates Ice Bath

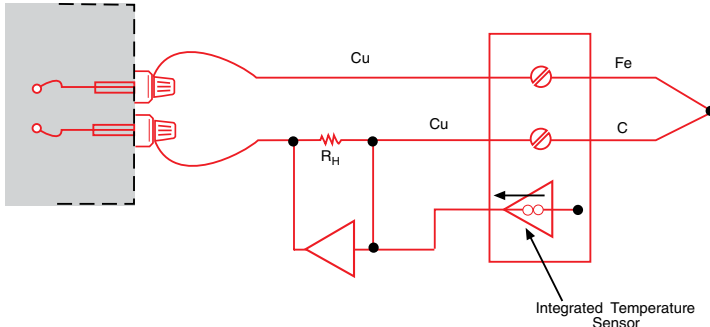

PRACTICAL HARDWARE COMPENSATION

Figure 15

The advantage of the hardware compensation circuit or *electronic ice point reference* is that we eliminate the need to compute the reference temperature. This saves us two computation steps and makes a hardware compensation temperature measurement somewhat faster than a software compensation measurement.

HARDWARE COMPENSATION	SOFTWARE COMPENSATION
Fast Restricted to one thermocouple type per card	Requires more computer manipulation time Versatile - accepts any thermocouple

TABLE 2

## Voltage-To-Temperature Conversion

We have used hardware and software compensation to synthesize an ice-point reference. Now all we have to do is to read the digital voltmeter and convert the voltage reading to a temperature. Unfortunately, the temperature-versus-voltage relationship of a thermocouple is not linear. Output voltages for the more common thermocouples are plotted as a function of temperature in Figure 16. If the slope of the curve (the Seebeck coefficient) is plotted vs. temperature, as in Figure 17, it becomes quite obvious that the thermocouple is a non-linear device.

A horizontal line in Figure 17 would indicate a constant  $\alpha$ , in other words, a linear device. We notice that the slope of the type K thermocouple approaches a constant over a temperature range from 0°C to 1000°C. Consequently, the type K can be used with a multiplying voltmeter and an external ice point reference to obtain a moderately accurate direct readout of temperature. That is, the temperature display involves only a scale factor. This procedure works with voltmeters.

By examining the variations in Seebeck coefficient, we can easily see that using one constant scale factor would limit the temperature range of the system and restrict the system accuracy. Better conversion accuracy can be obtained by reading the voltmeter and consulting the National Bureau of Standards Thermocouple Tables<sup>4</sup> on page Z-203 in this Handbook - see Table 3.

$$T = a_0 + a_1 x + a_2 x^2 + a_3 x^3 \dots + a_n x^n$$

where

T = Temperature

x = Thermocouple EMF in Volts

a = Polynomial coefficients unique to each thermocouple

n = Maximum order of the polynomial

As n increases, the accuracy of the polynomial improves. A representative number is n = 9 for ± 1°C accuracy. Lower order polynomials may be used over a narrow temperature range to obtain higher system speed.

Table 4 is an example of the polynomials used to convert voltage to temperature. Data may be utilized in packages for a data acquisition system. Rather than directly calculating the exponentials, the computer is programmed to use the *nested polynomial* form to save execution time. The polynomial *fit* rapidly degrades outside the temperature range shown in Table 4 and should not be extrapolated outside those limits.

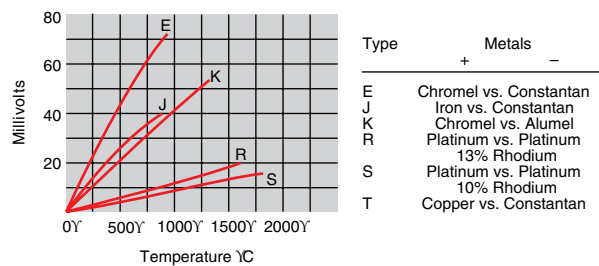

THERMOCOUPLE TEMPERATURE vs. VOLTAGE GRAPH

Figure 16

<sup>4</sup> Refer to Bibliography 4.

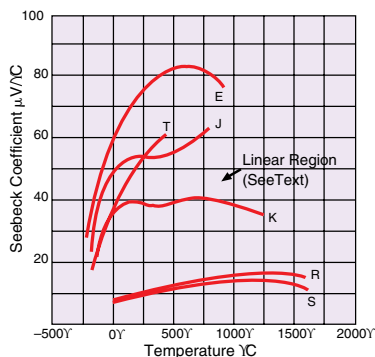

SEEBECK COEFFICIENT vs. TEMPERATURE  
Figure 17

mV	.00	.01	.02	.03	.04	.05	.06	.07	.08	.09	.10	mV
TEMPERATURES IN DEGREES C (IPTS 1968)												
0.00	0.00	0.17	0.34	0.51	0.68	0.85	1.02	1.19	1.36	1.53	1.70	0.00
0.10	1.70	1.87	2.04	2.21	2.38	2.55	2.72	2.89	3.06	3.23	3.40	0.10
0.20	3.40	3.57	3.74	3.91	4.08	4.25	4.42	4.58	4.75	4.92	5.09	0.20
0.30	5.09	5.26	5.43	5.60	5.77	5.94	6.11	6.27	6.44	6.61	6.78	0.30
0.40	6.78	6.95	7.12	7.29	7.46	7.62	7.79	7.96	8.13	8.30	8.47	0.40
0.50	8.47	8.63	8.80	8.97	9.14	9.31	9.47	9.64	9.81	9.98	10.15	0.50
0.60	10.15	10.31	10.48	10.65	10.82	10.98	11.15	11.32	11.49	11.65	11.82	0.60
0.70	11.82	11.99	12.16	12.32	12.49	12.66	12.83	12.99	13.16	13.33	13.49	0.70
0.80	13.49	13.66	13.83	13.99	14.16	14.33	14.49	14.66	14.83	14.99	15.16	0.80
0.90	15.16	15.33	15.49	15.66	15.83	15.99	16.16	16.33	16.49	16.66	16.83	0.90
1.00	16.83	16.99	17.16	17.32	17.49	17.66	17.82	17.99	18.15	18.32	18.48	1.00
1.10	18.48	18.65	18.82	18.98	19.15	19.31	19.48	19.64	19.81	19.97	20.14	1.10
1.20	20.14	20.31	20.47	20.64	20.80	20.97	21.13	21.30	21.46	21.63	21.79	1.20
1.30	21.79	21.96	22.12	22.29	22.45	22.62	22.78	22.94	23.11	23.27	23.44	1.30
1.40	23.44	23.60	23.77	23.93	24.10	24.26	24.42	24.59	24.75	24.92	25.08	1.40

TYPE E THERMOCOUPLE  
Table 3

	TYPE E Nickel-10% Chromium(+) Versus Constantan(-)	TYPE J Iron(+) Versus Constantan(-)	TYPE K Nickel-10% Chromium(+) Versus Nickel-5%(-) (Aluminum Silicon)	TYPE R Platinum-13% Rhodium(+) Versus Platinum(-)	TYPE S Platinum-10% Rhodium(+) Versus Platinum(-)	TYPE T Copper(+) Versus Constantan(-)
	-100°C to 1000°C ± 0.5°C	0°C to 760°C ± 0.1°C	0°C to 1370°C ± 0.7°C	0°C to 1000°C ± 0.5°C	0°C to 1750°C ± 1°C	-160°C to 400°C ± 0.5°C
	9th order	5th order	8th order	8th order	9th order	7th order
a <sub>0</sub>	0.104967248	-0.048868252	0.226584602	0.263632917	0.927763167	0.100860910
a <sub>1</sub>	17189.45282	19873.14503	24152.10900	179075.491	169526.5150	25727.94369
a <sub>2</sub>	-282639.0850	-218614.5353	67233.4248	-48840341.37	-31568363.94	-767345.8295
a <sub>3</sub>	12695339.5	11569199.78	2210340.682	1.90002E + 10	8990730663	78025595.81
a <sub>4</sub>	-448703084.6	-264917531.4	-860963914.9	-4.82704E + 12	-1.63565E + 12	-9247486589
a <sub>5</sub>	1.10866E + 10	2018441314	4.83506E + 10	7.62091E + 14	1.88027E + 14	6.97688E + 11
a <sub>6</sub>	-1.76807E + 11		-1.18452E + 12	-7.20026E + 16	-1.37241E + 16	-2.66192E + 13
a <sub>7</sub>	1.71842E + 12		1.38690E + 13	3.71496E + 18	6.17501E + 17	3.94078E + 14
a <sub>8</sub>	-9.19278E + 12		-6.33708E + 13	-8.03104E + 19	-1.56105E + 19	
a <sub>9</sub>	2.06132E + 13				1.69535E + 20	

TEMPERATURE CONVERSION EQUATION:  $T = a_0 + a_1x + a_2x^2 + \dots + a_nx^n$   
 NESTED POLYNOMIAL FORM:  $T = a_0 + x(a_1 + x(a_2 + x(a_3 + x(a_4 + a_5x))))$  (5th order)  
 where x is in Volts, T is in °C  
 NBS POLYNOMIAL COEFFICIENTS

Table 4

The calculation of high-order polynomials is a time-consuming task for a computer. As we mentioned before, we can save time by using a lower order polynomial for a smaller temperature range. In the software for one data acquisition system, the thermocouple characteristic curve is divided into eight sectors, and each sector is approximated by a third-order polynomial.\*

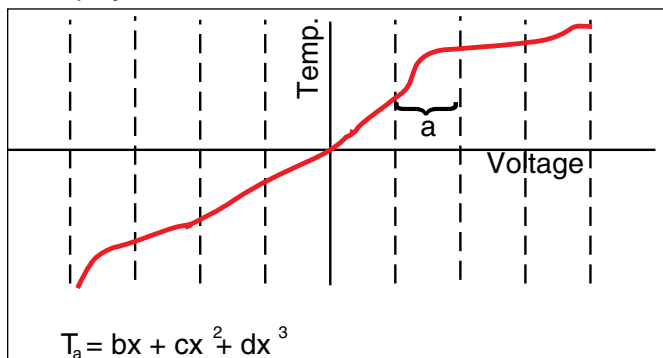

CURVE DIVIDED INTO SECTORS  
Figure 18

All the foregoing procedures assume the thermocouple voltage can be measured accurately and easily; however, a quick glance at Table 3 shows us that thermocouple output voltages are very small indeed. Examine the requirements of the system voltmeter:

THERMOCOUPLE TYPE	SEEBECK COEFFICIENT (µV/°C) @ 20°C	DVM SENSITIVITY FOR 0.1°C (µV)
E	62	6.2
J	51	5.1
K	40	4.0
R	7	0.7
S	7	0.7
T	40	4.0

REQUIRED DVM SENSITIVITY  
Table 5

Even for the common type K thermocouple, the voltmeter must be able to resolve 4 µV to detect a 0.1°C change. The magnitude of this signal is an open invitation for noise to creep into any system. For this reason, instrument designers utilize several fundamental noise rejection techniques, including tree switching, normal mode filtering, integration and

\* HEWLETT PACKARD 3054A.



# PRACTICAL THERMOCOUPLE MEASUREMENT

## Noise Rejection

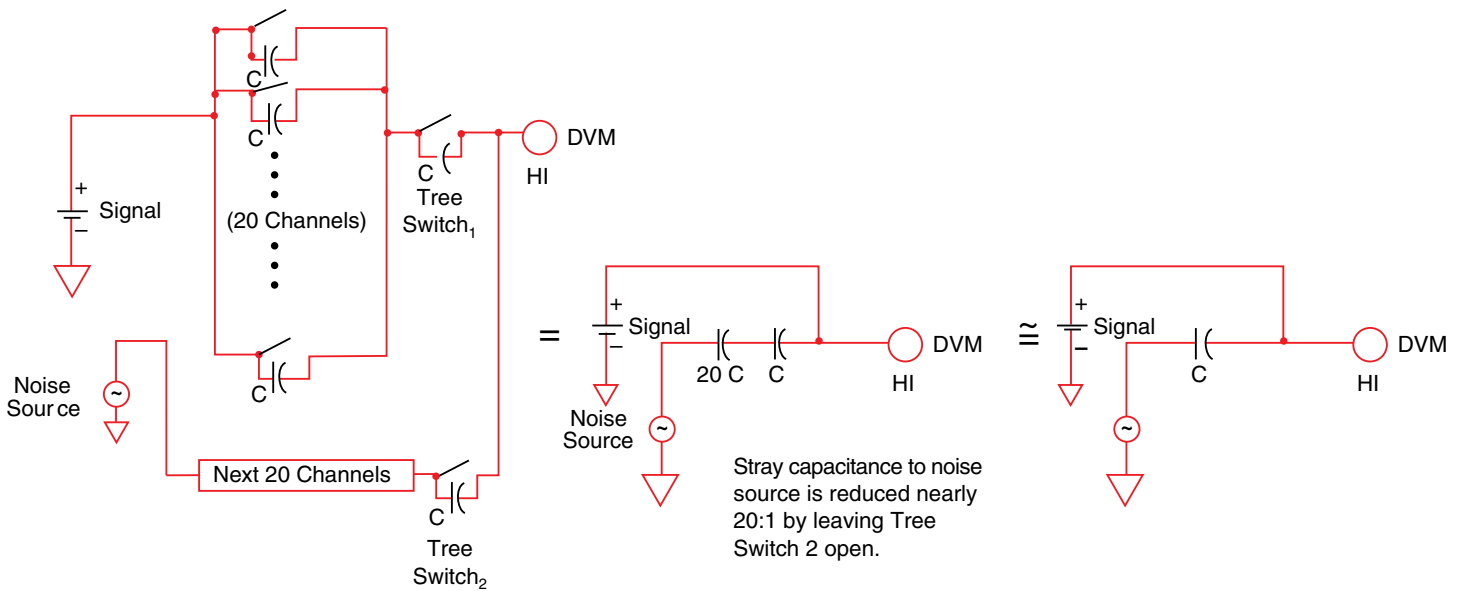

TREE SWITCHING

Figure 19

**Tree Switching** - Tree switching is a method of organizing the channels of a scanner into groups, each with its own main switch.

Without tree switching, every channel can contribute noise directly through its *stray* capacitance. With tree switching, groups of parallel channel capacitances are in series with a single *tree switch* capacitance. The result is greatly reduced crosstalk in a large data acquisition system, due to the reduced interchannel capacitance.

**Analog Filter** - A filter may be used directly at the input of a voltmeter to reduce noise. It reduces interference dramatically, but causes the voltmeter to respond more slowly to step inputs.

**Integration** - Integration is an A/D technique which essentially averages noise over a full line cycle; thus, power line related noise and its harmonics are virtually eliminated. If the integration period is chosen to be less than an integer line cycle, its noise rejection properties are essentially negated.

Since thermocouple circuits that cover long distances are especially susceptible to power line related noise, it is advisable to use an integrating analog-to-digital converter to measure the thermocouple voltage. Integration is an especially attractive A/D technique in light of recent innovations which allow reading rates of 48 samples per second with full cycle integration.

**Guarding** - Guarding is a technique used to reduce interference from any noise source that is common to both high and low measurement leads, *i.e.*, from *common mode* noise sources.

Let's assume a thermocouple wire has been pulled through the same conduit as a 220 Vac supply line. The capacitance between the power lines and the thermocouple lines will create an AC signal of approximately equal magnitude on both thermocouple wires. This *common mode* signal is not a problem in an ideal circuit, but the voltmeter is not ideal. It has some capacitance between its low terminal and safety ground (chassis). Current flows through this capacitance and through the thermocouple lead resistance, creating a normal mode noise signal. The guard, physically a floating metal box surrounding the entire voltmeter circuit, is connected to a shield surrounding the thermocouple wire, and serves to shunt the interfering current.

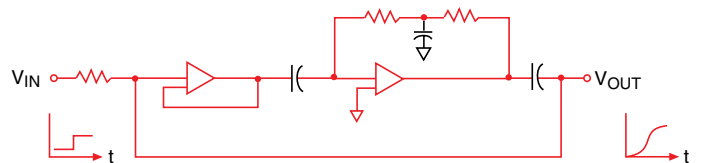

ANALOG FILTER

Figure 20

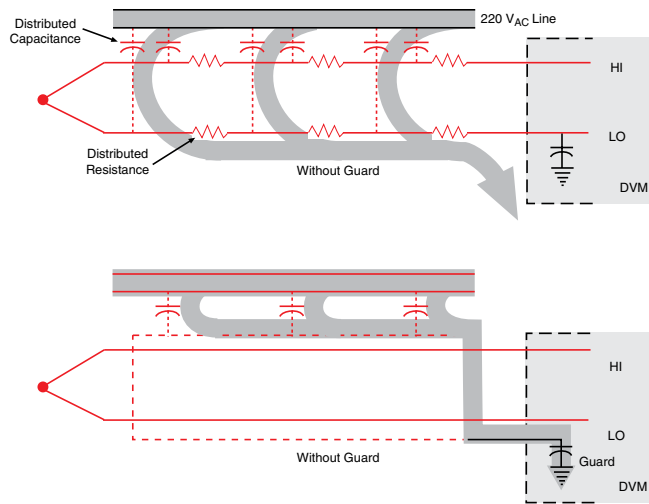

### GUARD SHUNTS INTERFERING WITH CURRENT

**Figure 21**

Each shielded thermocouple junction can directly contact an interfering source with no adverse effects, since provision is made on the scanner to switch the guard terminal separately for each thermocouple channel. This method of connecting the shield to guard serves to eliminate *ground loops* often created when the shields are connected to earth ground.

The dvm guard is especially useful in eliminating noise voltages created when the thermocouple junction comes into direct contact with a common mode noise source.

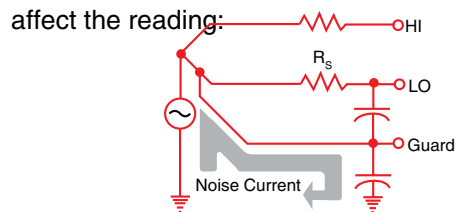

**Figure 24**

Notice that we can also minimize the noise by minimizing  $R_s$ . We do this by using larger thermocouple wire that has a smaller series resistance.

To reduce the possibility of magnetically induced noise, the thermocouple should be twisted in a uniform manner. Thermocouple *extension wires* are available commercially in a *twisted pair* configuration.

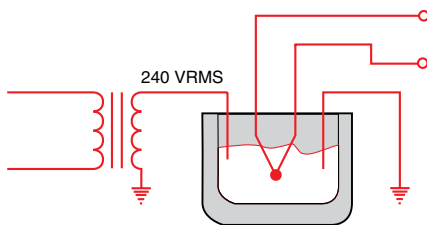

**Figure 22**

In Figure 22 we want to measure the temperature at the center of a molten metal bath that is being heated by electric current. The potential at the center of the bath is 120 V RMS. The equivalent circuit is:

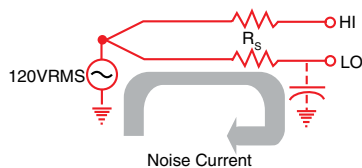

**Figure 23**

The stray capacitance from the dvm Lo terminal to chassis causes a current to flow in the low lead, which in turn causes a noise voltage to be dropped across the series resistance of the thermocouple,  $R_s$ . This voltage appears directly across the dvm Hi to Lo terminals and causes a noisy measurement. If we use a guard lead connected directly to the thermocouple, we drastically reduce the current flowing in the Lo lead. The noise current now flows in the guard lead where it cannot

**Practical Precautions** - We have discussed the concepts of the reference junction, how to use a polynomial to extract absolute temperature data, and what to look for in a data acquisition system, to minimize the effects of noise. Now let's look at the thermocouple wire itself. The polynomial curve fit relies upon the thermocouple wire being perfect; that is, it must not become *decalibrated* during the act of making a temperature measurement. We shall now discuss some of the pitfalls of thermocouple thermometry.

Aside from the specified accuracies of the data acquisition system and its zone box, most measurement errors may be traced to one of these primary sources:

1. Poor junction connection
2. Decalibration of thermocouple wire
3. Shunt impedance and galvanic action
4. Thermal shunting
5. Noise and leakage currents
6. Thermocouple specifications
7. Documentation

## Poor Junction Connection

There are a number of acceptable ways to connect two thermocouple wires: soldering, silver-soldering, welding, etc. When the thermocouple wires are soldered together, we introduce a third metal into the thermocouple circuit, but as long as the temperatures on both sides of the thermocouple are the same, the solder should not introduce any error. The solder does limit the maximum temperature to which we can subject this junction. To reach a higher measurement temperature, the joint must be welded. But welding is not a process to be taken lightly.<sup>5</sup> Overheating can degrade the wire, and the welding gas and the atmosphere in which the wire is welded can both diffuse into the thermocouple metal, changing its characteristics. The difficulty is compounded by the very different nature of the two metals being joined. Commercial thermocouples are welded on expensive machinery using a capacitive-discharge technique to insure uniformity.



Junction: Fe - Pb, Sn - C  $\cong$  Fe - C

SOLDERING A THERMOCOUPLE  
Figure 25

A poor weld can, of course, result in an open connection, which can be detected in a measurement situation by performing an *open thermocouple check*. This is a common test function available with dataloggers. While the open thermocouple is the easiest malfunction to detect, it is not necessarily the most common mode of failure.

## Decalibration

Decalibration is a far more serious fault condition than the open thermocouple because it can result in a temperature reading that *appears* to be correct. Decalibration describes the process of unintentionally altering the physical makeup of the thermocouple wire so that it no longer conforms to the NBS polynomial within specified limits. Decalibration can result from diffusion of atmospheric particles into the metal caused by temperature extremes. It can be caused by high temperature annealing or by *cold-working* the metal, an effect that can occur when the wire is drawn through a conduit or strained by rough handling or vibration. Annealing can occur within the section of wire that undergoes a temperature gradient.

<sup>5</sup> Refer to Bibliography 5

<sup>9</sup> Refer to Bibliography 9

<sup>7</sup> Refer to Bibliography 7

Robert Moffat in his *Gradient Approach to Thermocouple Thermometry* explains that the thermocouple voltage is actually generated by the section of wire that contains the temperature gradient, and not necessarily by the junction.<sup>9</sup> For example, if we have a thermal probe located in a molten metal bath, there will be two regions that are virtually isothermal and one that has a large gradient.

In Figure 26, the thermocouple junction will not produce *any* part of the output voltage. The shaded section will be the one producing virtually the entire thermocouple output voltage. If, due to aging or annealing, the output of this thermocouple were found

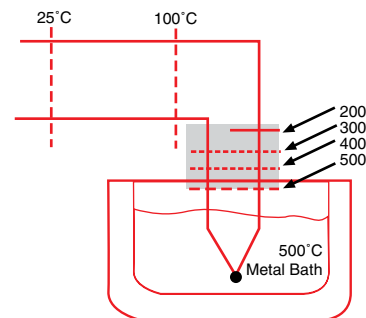

GRADIENT PRODUCES VOLTAGE  
Figure 26

to be drifting, then replacing the thermocouple junction alone would not solve the problem. We would have to replace the entire shaded section, since it is the source of the thermocouple voltage.

Thermocouple wire obviously can't be manufactured perfectly; there will be some defects which will cause output voltage errors. These *inhomogeneities* can be especially disruptive if they occur in a region of steep temperature gradient. Since we don't know where an imperfection will occur within a wire, the best thing we can do is to avoid creating a steep gradient. Gradients can be reduced by using metallic sleeving or by careful placement of the thermocouple wire.

## Shunt Impedance

High temperatures can also take their toll on thermocouple wire *insulators*. Insulation resistance decreases exponentially with increasing temperature, even to the point that it creates a *virtual junction*.<sup>7</sup> Assume we have a completely open thermocouple operating at a high temperature.

The leakage Resistance,  $R_L$ , can be sufficiently low to complete the circuit path and give us an improper voltage reading. Now let's assume the thermocouple is not open, but we are using a very long section of small diameter wire.

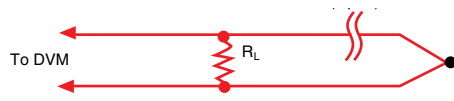

LEAKAGE RESISTANCE  
Figure 27

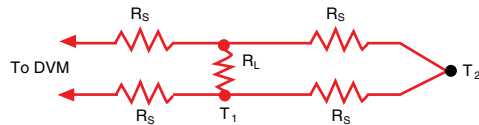

VIRTUAL JUNCTION  
Figure 28

If the thermocouple wire is small, its series resistance,  $R_s$ , will be quite high and under extreme conditions  $R_L \ll R_s$ . This means that the thermocouple *junction* will appear to be at  $R_L$  and the output will be proportional to  $T_1$  not  $T_2$ .

High temperatures have other detrimental effects on thermocouple wire. The impurities and chemicals within the insulation can actually diffuse into the thermocouple metal causing the temperature-voltage dependence to deviate from published values. When using thermocouples at high temperatures, the insulation should be chosen carefully. Atmospheric effects can be minimized by choosing the proper protective metallic or ceramic sheath

## Galvanic Action

The dyes used in some thermocouple insulation will form an electrolyte in the presence of water. This creates a galvanic action, with a resultant output hundreds of times greater than the Seebeck effect. Precautions should be taken to shield thermocouple wires from all harsh atmospheres and liquids.

## Thermal Shunting

No thermocouple can be made without mass. Since it takes energy to heat any mass, the thermocouple will slightly alter the temperature it is meant to measure. If the mass to be measured is small, the thermocouple must naturally be small. But a thermocouple made with small wire is far more susceptible to the problems of contamination, annealing, strain, and shunt impedance. To minimize these effects, thermocouple *extension wire* can be used. Extension wire is commercially available wire primarily intended to cover long distances between the measuring thermocouple and the voltmeter.

Extension wire is made of metals having Seebeck coefficients very similar to a particular thermocouple type. It is generally larger in size so that its series resistance does not become a factor when traversing long distances. It can also be pulled more readily through a conduit than can very small thermocouple

wire. It generally is specified over a much lower temperature range than premium grade thermocouple wire. In addition to offering a practical size advantage, extension wire is less expensive than standard thermocouple wire. This is especially true in the case of platinum-based thermocouples.

Since the extension wire is specified over a narrower temperature range and it is more likely to receive mechanical stress, the temperature gradient across the extension wire should be kept to a minimum. This, according to the gradient theory, assures that virtually none of the output signal will be affected by the extension wire.

**Noise** - We have already discussed line-related noise as it pertains to the data acquisition system. The techniques of integration, tree switching and guarding serve to cancel most line-related interference. Broadband noise can be rejected with the analog filter.

The one type of *noise* the data acquisition system cannot reject is a dc offset caused by a dc leakage current in the system. While it is less common to see dc leakage currents of sufficient magnitude to cause appreciable error, the possibility of their presence should be noted and prevented, especially if the thermocouple wire is very small and the related series impedance is high.

## Wire Calibration

Thermocouple wire is manufactured to a certain specification, signifying its conformance with the NBS tables. The specification can sometimes be enhanced by *calibrating* the wire (testing it at known temperatures). Consecutive pieces of wire on a continuous spool will generally track each other more closely than the specified tolerance, although their output voltages may be slightly removed from the center of the absolute specification.

If the wire is calibrated in an effort to improve its fundamental specifications, it becomes even more imperative that all of the aforementioned conditions be heeded in order to avoid decalibration.

**Documentation** - It may seem incongruous to speak of documentation as being a source of voltage measurement error, but the fact is that thermocouple systems, by their very ease of use, invite a large number of data points. The sheer magnitude of the data can become quite unwieldy. When a large amount of data is taken, there is an increased probability of error due to mislabeling of lines, using the wrong NBS curve, etc.

Since channel numbers invariably change, data should be categorized by measure and, not just channel number.<sup>6</sup> Information about any given measure and, such as transducer type, output voltage, typical value and location, can be maintained in a data file. This can be done under computer control or simply by filling out a pre-printed form. No matter how the data is maintained, the importance of a concise system should not be underestimated, especially at the outset of a complex data gathering project.

## Diagnostics

Most of the sources of error that we have mentioned are aggravated by using the thermocouple near its temperature limits. These conditions will be encountered infrequently in most applications. But what about the situation where we are using small thermocouples in a harsh atmosphere at high temperatures? How can we tell when the thermocouple is producing erroneous results? We need to develop a reliable set of diagnostic procedures.

Through the use of diagnostic techniques, R.P. Reed has developed an excellent system for detecting faulty thermocouples and data channels.<sup>10</sup> Three components of this system are the event record, the zone box test, and the thermocouple resistance history.

**Event Record** - The first diagnostic is not a test at all, but a recording of all pertinent events that could even remotely affect the measurements. An example would be:

### MARCH 18 EVENT RECORD

10:43 Power failure  
 10:47 System power returned  
 11:05 Changed M821 to type K thermocouple  
 13:51 New data acquisition program  
 16:07 M821 appears to be bad reading

**Figure 29**

We look at our program listing and find that measurand #M821 uses a type J thermocouple and that our new data acquisition program interprets it as a type J. But from the event record, apparently thermocouple M821 was changed to a type K, and the change was not entered into the program. While most anomalies are not discovered this easily, the event record can provide valuable insight into the reason for an unexplained change in a system measurement. This is especially true in a system configured to measure hundreds of data points.

<sup>10</sup> Refer to Bibliography 10

**Zone Box Test** - A zone box is an isothermal terminal block of known temperature used in place of an ice bath reference. If we temporarily short-circuit the thermocouple directly at the zone box, the system should read a temperature very close to that of the zone box, *i.e.*, close to room temperature.

If the thermocouple lead resistance is much greater than the shunting resistance, the copper wire shunt forces  $V = 0$ . In the normal *unshorted* case, we want to measure  $T_J$ , and the system reads:

$$V \cong \alpha (T_J - T_{REF})$$

But, for the functional test, we have shorted the terminals so that  $V=0$ . The indicated temperature  $T'_J$  is thus:

$$0 = \alpha (T'_J - T_{REF})$$

$$T'_J = T_{REF}$$

Thus, for a dvm reading of  $V = 0$ , the system will indicate the zone box temperature. First we observe the temperature  $T_J$  (forced to be different from  $T_{REF}$ ), then we short the thermocouple with a copper wire

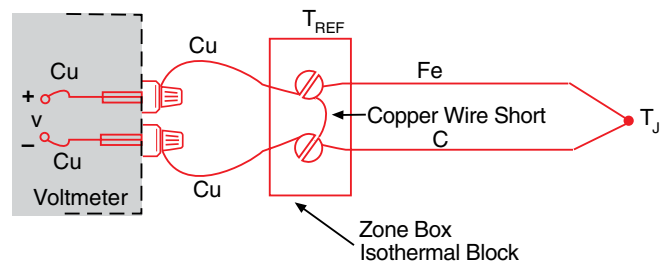

**SHORTING THE THERMOCOUPLE AT THE TERMINALS**

and make sure that the system indicates the zone box temperature instead of  $T_J$ .

This simple test verifies that the controller, scanner, voltmeter and zone box compensation are all operating correctly. In fact, this simple procedure tests everything but the thermocouple wire itself.

**Thermocouple Resistance** - A sudden change in the resistance of a thermocouple circuit can act as a warning indicator. If we plot resistance vs. time for each set of thermocouple wires, we can immediately spot a sudden resistance change, which could be an indication of an open wire, a wire shorted due to insulation failure, changes due to vibration fatigue, or one of many failure mechanisms.

For example, assume we have the thermocouple measurement shown in Figure 31.

We want to measure the temperature profile of an underground seam of coal that has been ignited. The wire passes through a high temperature region, into a cooler region. Suddenly, the temperature we measure

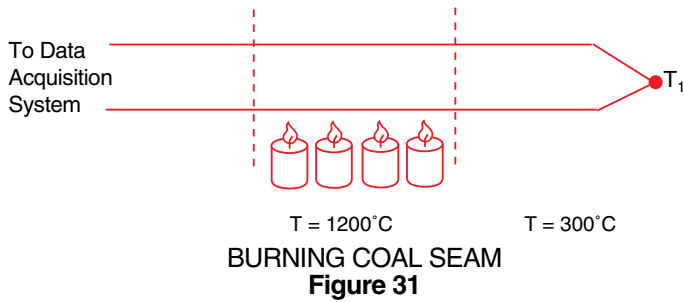

risers from  $300^{\circ}\text{C}$  to  $1200^{\circ}\text{C}$ . Has the burning section of the coal seam migrated to a different location, or has the thermocouple insulation failed, thus causing a short

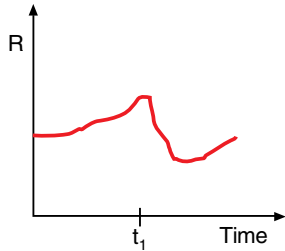

THERMOCOUPLE RESISTANCE vs. TIME

**Figure 32**

circuit between the two wires at the point of a hot spot?

If we have a continuous history of the thermocouple wire resistance, we can deduce what has actually happened.

The resistance of a thermocouple will naturally change with time as the resistivity of the wire changes

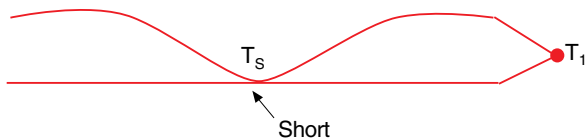

CAUSE OF THE RESISTANCE CHANGE

**Figure 33**

due to varying temperature. But a sudden change in resistance is an indication that something is wrong. In this case, the resistance has dropped abruptly, indicating that the insulation has failed, effectively shortening the thermocouple loop.

The new junction will measure temperature  $T_s$ , not  $T_1$ . The resistance measurement has given us additional information to help interpret the physical phenomenon detected by a standard *open thermocouple* check.

**Measuring Resistance** - We have casually mentioned checking the resistance of the thermocouple wire as if it were a straightforward measurement. But keep in mind that when the thermocouple is producing a voltage, this voltage can cause a large resistance measurement error. Measuring the resistance of a thermocouple is akin to measuring the internal

resistance of a battery. We can attack this problem with a technique known as *offset compensated ohms measurement*.

As the name implies, the voltmeter first measures the thermocouple offset voltage without the ohms current source applied. Then the ohms current source is switched on and the voltage across the resistance is measured again. The voltmeter software compensates for the offset voltage of the thermocouple and calculates the actual thermocouple source resistance.

**Special Thermocouples** - Under extreme conditions, we can even use diagnostic thermocouple circuit configurations. *Tip-branched* and *leg-branched* thermocouples are four-wire thermocouple circuits that allow redundant measurement of temperature, noise,

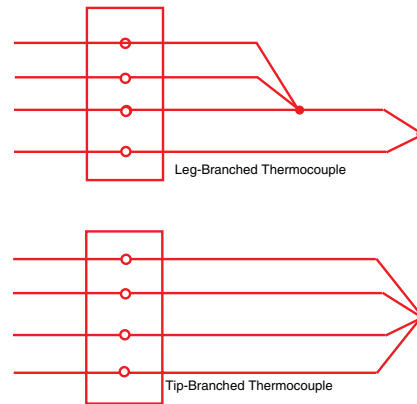

**Figure 34**

## Summary

In summary, the integrity of a thermocouple system can be improved by following these precautions:

- Use the largest wire possible that will not shunt heat away from the measurement area.
- If small wire is required, use it only in the region of the measurement and use extension wire for the region with no temperature gradient.
- Avoid mechanical stress and vibration which could strain the wires.
- When using long thermocouple wires, connect the wire shield to the dvm guard terminal and use twisted pair extension wire.
- Avoid steep temperature gradients.
- Try to use the thermocouple wire well within its temperature rating.
- Use a guarded integrating A/D converter.
- Use the proper sheathing material in hostile environments to protect the thermocouple wire.
- Use extension wire only at low temperatures and only in regions of small gradients.
- Keep an event log and a continuous record of thermocouple resistance.

## History

The same year that Seebeck made his discovery about thermoelectricity, Sir Humphrey Davy announced that the resistivity of metals showed a marked temperature dependence. Fifty years later, Sir William Siemens proffered the use of platinum as the element in a resistance thermometer. His choice proved most propitious, as platinum is used to this day as the primary element in all high-accuracy resistance thermometers. In fact, the Platinum Resistance Temperature Detector,<sup>15</sup> or PRTD, is used today as an interpolation standard from the oxygen point (-182.96°C) to the antimony point (630.74°C).

Platinum is especially suited to this purpose, as it can withstand high temperatures while maintaining excellent stability. As a noble metal, it shows limited susceptibility to contamination.

The classical resistance temperature detector (RTD) construction using platinum was proposed by C.H. Meyers in 1932.<sup>12</sup> He wound a helical coil of platinum on a crossed mica web and mounted the assembly inside a glass tube. This construction minimized strain on the wire while maximizing resistance.

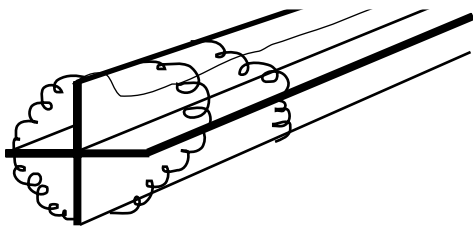

MYERS RTD CONSTRUCTION  
Figure 35

Although this construction produces a very stable element, the thermal contact between the platinum and the measured point is quite poor. This results in a slow thermal response time. The fragility of the structure limits its use today primarily to that of a laboratory standard.

Another laboratory standard has taken the place of Meyers' design. This is the *bird-cage* element proposed by Evans and Burns.<sup>16</sup> The platinum element remains largely unsupported, which allows it to move freely when expanded or contracted by temperature variations.

Strain-induced resistance changes over time and temperature are thus minimized, and the bird-cage becomes the ultimate laboratory standard. Due to the unsupported structure and subsequent susceptibility to vibration, this configuration is still a bit too fragile for industrial environments.

<sup>12</sup> Refer to Bibliography 12

<sup>15</sup> Refer to Bibliography 15

<sup>16</sup> Refer to Bibliography 16

A more rugged construction technique is shown in Figure 37. The platinum wire is bifilar wound on a glass or ceramic bobbin. The bifilar winding reduces the effective enclosed area of the coil to minimize magnetic pickup and its related noise. Once the wire is wound onto the bobbin, the assembly is then sealed with a coating of molten glass. The sealing process assures that the RTD will maintain its integrity under extreme vibration, but it also limits the expansion of the platinum metal at high temperatures. Unless the coefficients of expansion of the platinum and the bobbin match perfectly, stress will be placed on the wire as the temperature changes, resulting in a strain-induced resistance change. This may result in a permanent change in the resistance of the wire.

There are partially supported versions of the RTD which offer a compromise between the bird-cage approach and the sealed helix. One such approach uses a platinum helix threaded through a ceramic cylinder and affixed via glass-frit. These devices will maintain excellent stability in moderately rugged vibrational applications.

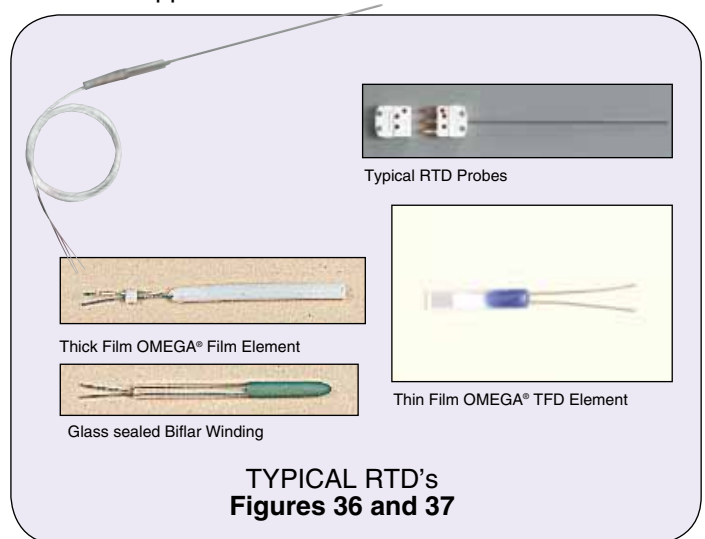

TYPICAL RTD's  
Figures 36 and 37

## Metal Film RTD's

In the newest construction technique, a platinum or metal-glass slurry film is deposited or screened onto a small flat ceramic substrate, etched with a laser- trimming system, and sealed. The film RTD offers substantial reduction in assembly time and has the further advantage of increased resistance for a given size. Due to the manufacturing technology, the device size itself is small, which means it can respond quickly to step changes in temperature. Film RTD's are presently less stable than their hand-made counterparts, but they are becoming more popular because of their decided advantages in size and production cost. These advantages should provide the impetus for future research needed to improve stability.

**Metals** - All metals produce a positive change in resistance for a positive change in temperature. This, of course, is the main function of an RTD. As we shall soon see, system error is minimized when the nominal value of the RTD resistance is large. This implies a metal wire with a high resistivity. The lower the resistivity of the metal, the more material we will have to use.

Table 6 lists the resistivities of common RTD materials.

METAL		RESISTIVITY OHM/CMF
		(cmf = circular mil foot)
Gold	Au	13.00
Silver	Ag	8.8
Copper	Cu	9.26
Platinum	Pt	59.00
Tungsten	w	30.00
Nickel	Ni	36.00

**Table 6**

Because of their lower resistivities, gold and silver are rarely used as RTD elements. Tungsten has a relatively high resistivity, but is reserved for very high temperature applications because it is extremely brittle and difficult to work.

Copper is used occasionally as an RTD element. Its low resistivity forces the element to be longer than a platinum element, but its linearity and very low cost make it an economical alternative. Its upper temperature limit is only about 120°C.

The most common RTD's are made of either platinum, nickel, or nickel alloys. The economical nickel derivative wires are used over a limited temperature range. They are quite non-linear and tend to drift with time. For measurement integrity, platinum is the obvious choice.

## Resistance Measurement

The common values of resistance for a platinum RTD range from 10 ohms for the bird-cage model to several thousand ohms for the film RTD. The single most common value is 100 ohms at 0°C. The DIN 43760 standard temperature coefficient of platinum wire is  $\alpha = 0.00385$ . For a 100 ohm wire, this corresponds to +0.385 ohms/°C at 0°C. This value for  $\alpha$  is actually the average slope from 0°C to 100°C. The more chemically pure platinum wire used in platinum resistance standards has an  $\alpha$  of +0.00392 ohms/ohm/°C.

Both the slope and the absolute value are small numbers, especially when we consider the fact that the measurement wires leading to the sensor may be several ohms or even tens of ohms. A small lead

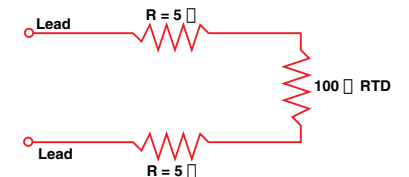

**EFFECT OF LEAD RESISTANCE**

**Figure 38**

impedance can contribute a significant error to our temperature measurement.

A ten ohm lead impedance implies  $10/0.385 \approx 26^\circ\text{C}$  error in measurement. Even the temperature coefficient of the lead wire can contribute a measurable error. The classical method of avoiding this problem has been the use of a bridge.

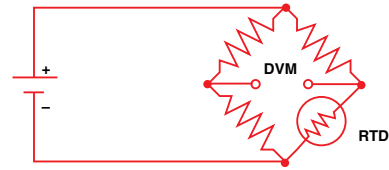

**WHEATSTONE BRIDGE**

**Figure 39**

The bridge output voltage is an indirect indication of the RTD resistance. The bridge requires four connection wires, an external source, and three resistors that have a zero temperature coefficient. To avoid subjecting the three bridge-completion resistors to the same temperature as the RTD, the RTD is separated from the bridge by a pair of extension wires:

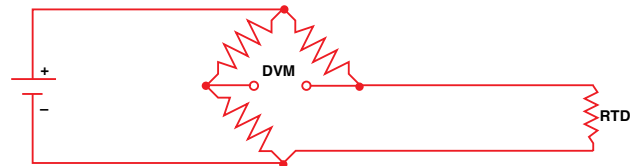

**Figure 40**

These extension wires recreate the problem that we had initially: The impedance of the extension wires affects the temperature reading. This effect can be minimized by using a *three-wire bridge* configuration:

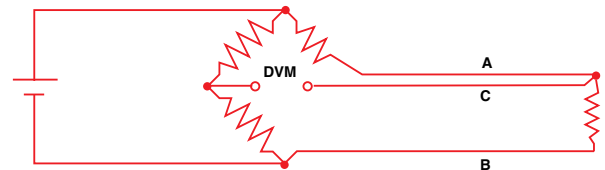

**3-WIRE BRIDGE**

**Figure 41**

If wires A and B are perfectly matched in length, their impedance effects will cancel because each is in an opposite leg of the bridge. The third wire, C, acts as a sense lead and carries no current.

The Wheatstone bridge shown in Figure 41 creates a non-linear relationship between resistance change and bridge output voltage change. This compounds the already non-linear temperature-resistance characteristic of the RTD by requiring an additional equation to convert bridge output voltage to equivalent RTD impedance.



**4-Wire Ohms** - The technique of using a current source along with a remotely sensed digital voltmeter alleviates many problems associated with the

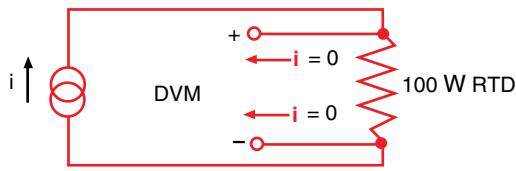

4-WIRE OHMS MEASUREMENT  
Figure 42

bridge. The output voltage read by the dvm is directly proportional to RTD resistance, so only one conversion equation is necessary. The three bridge-completion resistors are replaced by one reference resistor. The digital voltmeter measures only the voltage dropped across the RTD and is insensitive to the length of the lead wires.

The one disadvantage of using 4-wire ohms is that we need one more extension wire than the 3-wire bridge.

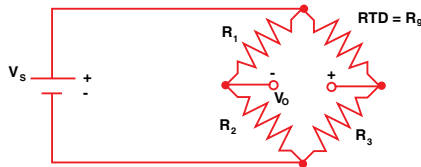

Figure 43

This is a small price to pay if we are at all concerned with the accuracy of the temperature measurement.

### 3-Wire Bridge Measurement Errors

If we know  $V_s$  and  $V_o$ , we can find  $R_g$  and then solve for temperature. The unbalance voltage  $V_o$  of a bridge built with  $R_1 = R_2$  is:

$$V_o = V_s \left( \frac{R_3}{R_3 + R_g} \right) - V_s \frac{1}{2} \quad (2)$$

If  $R_g = R_3$ ,  $V_o = 0$  and the bridge is balanced. This can be done manually, but if we don't want to do a manual bridge balance, we can just solve for  $R_g$  in terms of  $V_o$ :

$$R_g = R_3 \left( \frac{V_s - 2V_o}{V_s + 2V_o} \right)$$

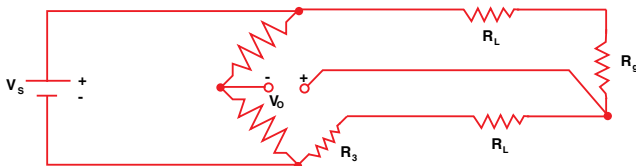

Figure 44

This expression assumes the lead resistance is zero. If  $R_g$  is located some distance from the bridge in a 3-wire configuration, the lead resistance  $R_L$  will appear  
<sup>11, 13</sup> Refer to Bibliography 11 and 13.

in series with both  $R_g$  and  $R_3$ :

Again we solve for  $R_g$ :

$$R_g = R_3 \left( \frac{V_s - 2V_o}{V_s + 2V_o} \right) - R_L \left( \frac{4V_o}{V_s + 2V_o} \right)$$

The error term will be small if  $V_o$  is small, *i.e.*, the

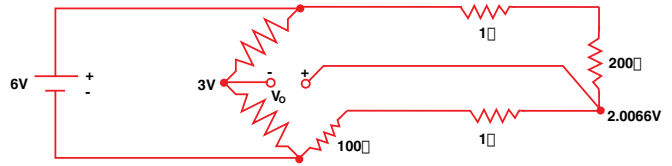

Figure 45

bridge is close to balance. This circuit works well with devices like strain gauges, which change resistance value by only a few percent, but an RTD changes resistance dramatically with temperature. Assume the RTD resistance is 200 ohms and the bridge is designed for 100 ohms:

Since we don't know the value of  $R_L$ , we must use equation (a), so we get:

$$R_g = 100 \left( \frac{6 - 1.9868}{6 + 1.9868} \right) = 199.01 \text{ ohms}$$

The correct answer is of course 200 ohms. That's a

## Resistance to Temperature Conversion

The RTD is a more linear device than the thermocouple, but it still requires curve-fitting. The Callendar-Van Dusen equation has been used for years to approximate the RTD curve:<sup>11, 13</sup>

$$R_T = R_0 + R_0 \alpha \left[ T - \left( \frac{T}{100} - 1 \right) \left( \frac{T}{100} \right) - \left( \frac{T}{100} - 1 \right) \left( \frac{T}{100} \right)^2 \right]$$

Where:

- $R_T$  = Resistance at Temperature T
- $R_0$  = Resistance at  $T = 0^\circ\text{C}$
- $\alpha$  = Temperature coefficient at  $T = 0^\circ\text{C}$   
(typically  $+0.00392\Omega/\Omega/^\circ\text{C}$ )
- $\delta$  = 1.49 (typical value for .00392 platinum)
- = 0  $T > 0$
- 0.11 (typical)  $T < 0$

The exact values for coefficients  $\alpha$ ,  $\delta$ , and  $\delta$  are determined by testing the RTD at four temperatures and solving the resultant equations. This familiar equation was replaced in 1968 by a 20th order polynomial in order to provide a more accurate curve fit.

The plot of this equation shows the RTD to be a more linear device than the thermocouple: